

Notice for TAIYO YUDEN products

Please read this notice before using the TAIYO YUDEN products.

REMINDERS

- Product information in this catalog is as of October 2014. All of the contents specified herein are subject to change without notice due to technical improvements, etc. Therefore, please check for the latest information carefully before practical application or usage of the Products.

Please note that TAIYO YUDEN CO., LTD. shall not be responsible for any defects in products or equipment incorporating such products, which are caused under the conditions other than those specified in this catalog or individual specification.

- Please contact TAIYO YUDEN CO., LTD. for further details of product specifications as the individual specification is available.
- Please conduct validation and verification of products in actual condition of mounting and operating environment before commercial shipment of the equipment.

- All electronic components or functional modules listed in this catalog are developed, designed and intended for use in general electronics equipment.(for AV, office automation, household, office supply, information service, telecommunications, (such as mobile phone or PC) etc.). Before incorporating the components or devices into any equipment in the field such as transportation,(automotive control, train control, ship control), transportation signal, disaster prevention, medical, public information network (telephone exchange, base station) etc. which may have direct influence to harm or injure a human body, please contact TAIYO YUDEN CO., LTD. for more detail in advance.

Do not incorporate the products into any equipment in fields such as aerospace, aviation, nuclear control, submarine system, military, etc. where higher safety and reliability are especially required.

In addition, even electronic components or functional modules that are used for the general electronic equipment, if the equipment or the electric circuit require high safety or reliability function or performances, a sufficient reliability evaluation check for safety shall be performed before commercial shipment and moreover, due consideration to install a protective circuit is strongly recommended at customer's design stage.

- The contents of this catalog are applicable to the products which are purchased from our sales offices or distributors (so called "TAIYO YUDEN' s official sales channel").
It is only applicable to the products purchased from any of TAIYO YUDEN' s official sales channel.

- Please note that TAIYO YUDEN CO., LTD. shall have no responsibility for any controversies or disputes that may occur in connection with a third party's intellectual property rights and other related rights arising from your usage of products in this catalog. TAIYO YUDEN CO., LTD. grants no license for such rights.

- Caution for export

Certain items in this catalog may require specific procedures for export according to "Foreign Exchange and Foreign Trade Control Law" of Japan, "U.S. Export Administration Regulations", and other applicable regulations. Should you have any question or inquiry on this matter, please contact our sales staff.

MULTILAYER CHIP INDUCTORS FOR HIGH FREQUENCY APPLICATIONS(HK SERIES)

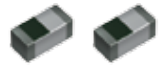

WAVE* REFLOW

*Except for HK0402, HK0603, HK1005

PARTS NUMBER

*Operating Temp.: -55~+125°C (HK1608/2125 : -40~+85°C)

| | | | | | | | | | | | | | |
|---|---|---|---|---|---|---|---|---|---|---|---|---|---|
| H | K | △ | 0 | 6 | 0 | 3 | △ | 1 | 0 | N | J | - | T |
| ① | ② | | | | | | | ③ | ④ | | ⑤ | | |

△=Blank space

①Series name

| Code | Series name |
|------|---|
| HK△ | Multilayer chip inductor for high frequency |

②Dimensions (L×W)

| Code | Type (inch) | Dimensions (L×W) [mm] |
|------|-------------|-----------------------|
| 0402 | 0402(01005) | 0.4×0.2 |
| 0603 | 0603(0201) | 0.6×0.3 |
| 1005 | 1005(0402) | 1.0×0.5 |
| 1608 | 1608(0603) | 1.6×0.8 |
| 2125 | 2125(0805) | 2.0×1.2 |

③Nominal inductance

| Code (example) | Nominal inductance [nH] |
|----------------|-------------------------|
| 3N9 | 3.9 |
| 10N | 10.0 |
| R10 | 100 |
| R12 | 120 |

※R=Decimal point

※N=0.0(nH type)

④Inductance tolerance

| Code | Inductance tolerance |
|------|----------------------|
| H | ±3% |
| J | ±5% |
| C | ±0.2nH |
| S | ±0.3nH |

⑤Packaging

| Code | Packaging |
|------|-----------|
| -T | Taping |

STANDARD EXTERNAL DIMENSIONS / STANDARD QUANTITY

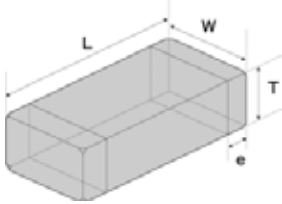

| Type | L | W | T | e | Standard quantity [pcs] | |
|--------------------|--------------------------------------|---------------------------|--------------------------------------|----------------------------|-------------------------|---------------|
| | | | | | Paper tape | Embossed tape |
| HK 0402 (01005) | 0.4±0.02 (0.016±0.001) | 0.2±0.02 (0.008±0.001) | 0.2±0.02 (0.008±0.001) | 0.1±0.03 (0.004±0.001) | 20000 | - |
| HK 0603 (0201) | 0.6±0.03 (0.024±0.001) | 0.3±0.03 (0.012±0.001) | 0.3±0.03 (0.012±0.001) | 0.15±0.05 (0.006±0.002) | 15000 | - |
| HK 1005 (0402) | 1.0±0.05 (0.039±0.002) | 0.5±0.05 (0.020±0.002) | 0.5±0.05 (0.020±0.002) | 0.25±0.10 (0.010±0.004) | 10000 | - |
| HK 1608 (0603) | 1.6±0.15 (0.063±0.006) | 0.8±0.15 (0.031±0.006) | 0.8±0.15 (0.031±0.006) | 0.3±0.2 (0.012±0.008) | 4000 | - |
| HK 2125 (0805) | 2.0+0.3/-0.1 (0.079+0.012/-0.004) | 1.25±0.2 (0.049±0.008) | 0.85±0.2 (0.033±0.008) | 0.5±0.3 (0.020±0.012) | - | 4000 |
| | 2.0+0.3/-0.1 (0.079+0.012/-0.004) | 1.25±0.2 (0.049±0.008) | 1.0+0.2/-0.3 (0.039+0.008/-0.012) | 0.5±0.3 (0.020±0.012) | - | 3000 |

Unit: mm (inch)

► This catalog contains the typical specification only due to the limitation of space. When you consider the purchase of our products, please check our specification. For details of each product (characteristics graph, reliability information, precautions for use, and so on), see our Web site (<http://www.ty-top.com/>).

● HK 0402

| Parts number | EHS | Nominal inductance [nH] | Inductance tolerance | Q (min.) | LQ Measuring frequency [MHz] | Q (Typical) frequency [MHz] | | | | | Self-resonant frequency [MHz] | | DC Resistance [Ω] (max.) | | Rated current [mA] (max.) | Thickness [mm] |
|----------------|------|-------------------------|----------------------|----------|------------------------------|-----------------------------|-----|-----|-----|------|-------------------------------|---------|-----------------------------------|--------|---------------------------|----------------|
| | | | | | | 100 | 300 | 500 | 800 | 1000 | (min.) | (typ.) | (max.) | (typ.) | | |
| HK 0402 1N0□-T | RoHS | 1.0 | $\pm 0.3\text{nH}$ | 3 | 100 | 4 | 7 | 9 | 12 | 14 | 10000 | > 13500 | 0.18 | 380 | 0.20 ± 0.02 | |
| HK 0402 1N2□-T | RoHS | 1.2 | $\pm 0.3\text{nH}$ | 3 | 100 | 4 | 7 | 9 | 12 | 14 | 10000 | > 13500 | 0.19 | 370 | 0.20 ± 0.02 | |
| HK 0402 1N5□-T | RoHS | 1.5 | $\pm 0.3\text{nH}$ | 3 | 100 | 4 | 7 | 9 | 11 | 12 | 10000 | > 13500 | 0.24 | 330 | 0.20 ± 0.02 | |
| HK 0402 1N8□-T | RoHS | 1.8 | $\pm 0.3\text{nH}$ | 3 | 100 | 4 | 7 | 9 | 11 | 12 | 10000 | 13100 | 0.27 | 310 | 0.20 ± 0.02 | |
| HK 0402 2N2□-T | RoHS | 2.2 | $\pm 0.3\text{nH}$ | 3 | 100 | 4 | 7 | 9 | 11 | 12 | 9800 | 11300 | 0.29 | 290 | 0.20 ± 0.02 | |
| HK 0402 2N7□-T | RoHS | 2.7 | $\pm 0.3\text{nH}$ | 3 | 100 | 4 | 7 | 9 | 11 | 12 | 8800 | 10300 | 0.35 | 270 | 0.20 ± 0.02 | |
| HK 0402 3N3□-T | RoHS | 3.3 | $\pm 0.3\text{nH}$ | 3 | 100 | 4 | 7 | 9 | 11 | 12 | 7300 | 8800 | 0.42 | 240 | 0.20 ± 0.02 | |
| HK 0402 3N9□-T | RoHS | 3.9 | $\pm 0.3\text{nH}$ | 3 | 100 | 4 | 7 | 9 | 11 | 12 | 6800 | 8300 | 0.46 | 230 | 0.20 ± 0.02 | |
| HK 0402 4N7□-T | RoHS | 4.7 | $\pm 0.3\text{nH}$ | 3 | 100 | 4 | 6 | 8 | 10 | 11 | 6400 | 7900 | 0.52 | 220 | 0.20 ± 0.02 | |
| HK 0402 5N6□-T | RoHS | 5.6 | $\pm 0.3\text{nH}$ | 3 | 100 | 4 | 6 | 8 | 10 | 11 | 5100 | 6600 | 0.63 | 200 | 0.20 ± 0.02 | |
| HK 0402 6N8□-T | RoHS | 6.8 | $\pm 5\%$ | 3 | 100 | 4 | 6 | 8 | 10 | 11 | 4400 | 5900 | 0.71 | 180 | 0.20 ± 0.02 | |
| HK 0402 8N2□-T | RoHS | 8.2 | $\pm 5\%$ | 3 | 100 | 4 | 6 | 8 | 10 | 11 | 4100 | 5600 | 0.81 | 170 | 0.20 ± 0.02 | |
| HK 0402 10N□-T | RoHS | 10 | $\pm 5\%$ | 3 | 100 | 4 | 6 | 8 | 10 | 11 | 3400 | 4900 | 0.93 | 160 | 0.20 ± 0.02 | |
| HK 0402 12N□-T | RoHS | 12 | $\pm 5\%$ | 3 | 100 | 4 | 6 | 8 | 10 | 11 | 2900 | 4400 | 0.99 | 160 | 0.20 ± 0.02 | |

※ □ mark indicates the Inductance tolerance code.

● HK 0603

| Parts number | EHS | Nominal inductance [nH] | Inductance tolerance ※) | Q (min.) | LQ Measuring frequency [MHz] | Q (Typical) frequency [MHz] | | | | | Self-resonant frequency [MHz] | | DC Resistance [Ω] (max.) | | Rated current [mA] (max.) | Thickness [mm] |
|----------------|------|-------------------------|-------------------------|----------|------------------------------|-----------------------------|-----|-----|-----|------|-------------------------------|---------|-----------------------------------|--------|---------------------------|-----------------|
| | | | | | | 100 | 300 | 500 | 800 | 1000 | (min.) | (typ.) | (max.) | (typ.) | | |
| HK 0603 1N0□-T | RoHS | 1.0 | $\pm 0.3\text{nH}$ | 4 | 100 | 6 | 12 | 17 | 22 | 27 | 10000 | > 13000 | 0.11 | 0.088 | 470 | 0.30 ± 0.03 |
| HK 0603 1N2□-T | RoHS | 1.2 | $\pm 0.3\text{nH}$ | 4 | 100 | 6 | 12 | 16 | 21 | 25 | 10000 | > 13000 | 0.12 | 0.089 | 450 | 0.30 ± 0.03 |
| HK 0603 1N5□-T | RoHS | 1.5 | $\pm 0.3\text{nH}$ | 4 | 100 | 6 | 12 | 15 | 20 | 23 | 10000 | > 13000 | 0.13 | 0.11 | 430 | 0.30 ± 0.03 |
| HK 0603 1N8□-T | RoHS | 1.8 | $\pm 0.3\text{nH}$ | 4 | 100 | 6 | 12 | 15 | 20 | 23 | 10000 | > 13000 | 0.16 | 0.12 | 390 | 0.30 ± 0.03 |
| HK 0603 2N0□-T | RoHS | 2.0 | $\pm 0.3\text{nH}$ | 4 | 100 | 6 | 12 | 15 | 20 | 22 | 10000 | > 13000 | 0.17 | 0.13 | 380 | 0.30 ± 0.03 |
| HK 0603 2N2□-T | RoHS | 2.2 | $\pm 0.3\text{nH}$ | 4 | 100 | 6 | 12 | 15 | 20 | 22 | 8800 | 12500 | 0.19 | 0.14 | 360 | 0.30 ± 0.03 |
| HK 0603 2N4□-T | RoHS | 2.4 | $\pm 0.3\text{nH}$ | 4 | 100 | 6 | 12 | 15 | 20 | 22 | 8300 | 11700 | 0.20 | 0.15 | 350 | 0.30 ± 0.03 |
| HK 0603 2N7□-T | RoHS | 2.7 | $\pm 0.3\text{nH}$ | 5 | 100 | 7 | 12 | 15 | 20 | 22 | 7700 | 11000 | 0.21 | 0.16 | 340 | 0.30 ± 0.03 |
| HK 0603 3N0□-T | RoHS | 3.0 | $\pm 0.3\text{nH}$ | 5 | 100 | 7 | 12 | 15 | 20 | 22 | 7200 | 11000 | 0.22 | 0.18 | 330 | 0.30 ± 0.03 |
| HK 0603 3N3□-T | RoHS | 3.3 | $\pm 0.3\text{nH}$ | 5 | 100 | 7 | 12 | 15 | 20 | 22 | 6700 | 9600 | 0.23 | 0.19 | 320 | 0.30 ± 0.03 |
| HK 0603 3N6□-T | RoHS | 3.6 | $\pm 0.3\text{nH}$ | 5 | 100 | 7 | 12 | 15 | 20 | 22 | 6400 | 9100 | 0.25 | 0.20 | 310 | 0.30 ± 0.03 |
| HK 0603 3N9□-T | RoHS | 3.9 | $\pm 0.3\text{nH}$ | 5 | 100 | 7 | 12 | 15 | 20 | 22 | 6000 | 8600 | 0.27 | 0.20 | 300 | 0.30 ± 0.03 |
| HK 0603 4N3□-T | RoHS | 4.3 | $\pm 0.3\text{nH}$ | 5 | 100 | 7 | 12 | 15 | 19 | 21 | 5700 | 8100 | 0.30 | 0.22 | 280 | 0.30 ± 0.03 |
| HK 0603 4N7□-T | RoHS | 4.7 | $\pm 0.3\text{nH}$ | 5 | 100 | 7 | 12 | 15 | 19 | 21 | 5300 | 7600 | 0.30 | 0.24 | 280 | 0.30 ± 0.03 |
| HK 0603 5N1□-T | RoHS | 5.1 | $\pm 0.3\text{nH}$ | 5 | 100 | 7 | 12 | 15 | 19 | 21 | 5000 | 7100 | 0.33 | 0.26 | 270 | 0.30 ± 0.03 |
| HK 0603 5N6□-T | RoHS | 5.6 | $\pm 0.3\text{nH}$ | 5 | 100 | 7 | 12 | 15 | 19 | 21 | 4600 | 6600 | 0.36 | 0.27 | 260 | 0.30 ± 0.03 |
| HK 0603 6N2□-T | RoHS | 6.2 | $\pm 0.3\text{nH}$ | 5 | 100 | 7 | 11 | 14 | 18 | 20 | 4200 | 6100 | 0.38 | 0.29 | 250 | 0.30 ± 0.03 |
| HK 0603 6N8□-T | RoHS | 6.8 | $\pm 5\%$ | 5 | 100 | 7 | 11 | 14 | 18 | 20 | 3900 | 5600 | 0.39 | 0.30 | 250 | 0.30 ± 0.03 |
| HK 0603 7N5□-T | RoHS | 7.5 | $\pm 5\%$ | 5 | 100 | 7 | 11 | 14 | 18 | 19 | 3600 | 5300 | 0.41 | 0.34 | 240 | 0.30 ± 0.03 |
| HK 0603 8N2□-T | RoHS | 8.2 | $\pm 5\%$ | 5 | 100 | 7 | 11 | 14 | 18 | 19 | 3400 | 4900 | 0.45 | 0.34 | 230 | 0.30 ± 0.03 |
| HK 0603 9N1□-T | RoHS | 9.1 | $\pm 5\%$ | 5 | 100 | 7 | 11 | 14 | 17 | 18 | 3200 | 4600 | 0.48 | 0.40 | 220 | 0.30 ± 0.03 |
| HK 0603 10N□-T | RoHS | 10 | $\pm 5\%$ | 5 | 100 | 7 | 11 | 14 | 17 | 18 | 2900 | 4200 | 0.51 | 0.41 | 220 | 0.30 ± 0.03 |
| HK 0603 12N□-T | RoHS | 12 | $\pm 5\%$ | 5 | 100 | 7 | 11 | 14 | 17 | 18 | 2700 | 3800 | 0.68 | 0.45 | 190 | 0.30 ± 0.03 |
| HK 0603 15N□-T | RoHS | 15 | $\pm 5\%$ | 5 | 100 | 7 | 11 | 13 | 16 | 17 | 2300 | 3300 | 0.71 | 0.50 | 180 | 0.30 ± 0.03 |
| HK 0603 18N□-T | RoHS | 18 | $\pm 5\%$ | 5 | 100 | 7 | 11 | 13 | 16 | 17 | 2100 | 3000 | 0.81 | 0.57 | 170 | 0.30 ± 0.03 |
| HK 0603 22N□-T | RoHS | 22 | $\pm 5\%$ | 5 | 100 | 7 | 11 | 13 | 15 | 16 | 1800 | 2600 | 1.00 | 0.71 | 150 | 0.30 ± 0.03 |
| HK 0603 27N□-T | RoHS | 27 | $\pm 5\%$ | 4 | 100 | 6 | 10 | 12 | 14 | 15 | 1800 | 2600 | 1.35 | 1.11 | 120 | 0.30 ± 0.03 |
| HK 0603 33N□-T | RoHS | 33 | $\pm 5\%$ | 4 | 100 | 6 | 10 | 12 | 14 | 14 | 1700 | 2400 | 1.47 | 1.33 | 110 | 0.30 ± 0.03 |
| HK 0603 39N□-T | RoHS | 39 | $\pm 5\%$ | 4 | 100 | 6 | 10 | 12 | 13 | 12 | 1500 | 2100 | 1.72 | 1.51 | 100 | 0.30 ± 0.03 |
| HK 0603 47N□-T | RoHS | 47 | $\pm 5\%$ | 4 | 100 | 6 | 10 | 11 | 12 | 11 | 1300 | 1800 | 1.90 | 1.74 | 100 | 0.30 ± 0.03 |
| HK 0603 56N□-T | RoHS | 56 | $\pm 5\%$ | 4 | 100 | 6 | 10 | 11 | 11 | 10 | 1100 | 1600 | 2.27 | 1.85 | 80 | 0.30 ± 0.03 |
| HK 0603 68N□-T | RoHS | 68 | $\pm 5\%$ | 4 | 100 | 6 | 10 | 11 | 11 | 10 | 1100 | 1500 | 2.66 | 2.30 | 80 | 0.30 ± 0.03 |
| HK 0603 82N□-T | RoHS | 82 | $\pm 5\%$ | 4 | 100 | 6 | 10 | 11 | 10 | 8 | 1000 | 1400 | 3.37 | 2.60 | 70 | 0.30 ± 0.03 |
| HK 0603 R10□-T | RoHS | 100 | $\pm 5\%$ | 4 | 100 | 6 | 9 | 10 | 9 | 6 | 900 | 1200 | 3.74 | 3.00 | 60 | 0.30 ± 0.03 |

※ □ mark indicates the Inductance tolerance code. Please refer for the inductance tolerance except the above.

HK 1005

| Parts number | EHS | Nominal inductance [nH] | Inductance tolerance ※ | Q (min.) | LQ Measuring frequency [MHz] | Q (Typical) frequency [MHz] | | | | | Self-resonant frequency [MHz] | | DC Resistance [Ω] | | Rated current [mA] (max.) | | Thickness [mm] |
|---------------|------|-------------------------|------------------------|----------|------------------------------|-----------------------------|-----|-----|-----|------|-------------------------------|---------|-------------------|--------|---------------------------|-----------|----------------|
| | | | | | | 100 | 300 | 500 | 800 | 1000 | (min.) | (typ.) | (max.) | (typ.) | -55~+125°C | -55~+85°C | |
| HK 1005 1N0-T | RoHS | 1.0 | ±0.3nH | 8 | 100 | 11 | 25 | 34 | 43 | 52 | 10000 | > 13000 | 0.08 | 0.04 | 300 | 900 | 0.50 ±0.05 |
| HK 1005 1N2-T | RoHS | 1.2 | ±0.3nH | 8 | 100 | 11 | 25 | 35 | 44 | 52 | 10000 | > 13000 | 0.09 | 0.04 | 300 | 900 | 0.50 ±0.05 |
| HK 1005 1N5-T | RoHS | 1.5 | ±0.3nH | 8 | 100 | 11 | 24 | 33 | 44 | 48 | 6000 | > 13000 | 0.10 | 0.05 | 300 | 850 | 0.50 ±0.05 |
| HK 1005 1N8-T | RoHS | 1.8 | ±0.3nH | 8 | 100 | 11 | 23 | 30 | 36 | 42 | 6000 | 11000 | 0.12 | 0.06 | 300 | 700 | 0.50 ±0.05 |
| HK 1005 2N0-T | RoHS | 2.0 | ±0.3nH | 8 | 100 | 11 | 21 | 27 | 34 | 39 | 6000 | 10500 | 0.12 | 0.06 | 300 | 700 | 0.50 ±0.05 |
| HK 1005 2N2-T | RoHS | 2.2 | ±0.3nH | 8 | 100 | 10 | 18 | 25 | 31 | 36 | 6000 | 10000 | 0.13 | 0.07 | 300 | 700 | 0.50 ±0.05 |
| HK 1005 2N4-T | RoHS | 2.4 | ±0.3nH | 8 | 100 | 10 | 18 | 24 | 31 | 35 | 6000 | 9500 | 0.13 | 0.07 | 300 | 650 | 0.50 ±0.05 |
| HK 1005 2N7-T | RoHS | 2.7 | ±0.3nH | 8 | 100 | 10 | 18 | 24 | 31 | 34 | 6000 | 9000 | 0.13 | 0.08 | 300 | 650 | 0.50 ±0.05 |
| HK 1005 3N0-T | RoHS | 3.0 | ±0.3nH | 8 | 100 | 10 | 18 | 24 | 31 | 35 | 6000 | 8500 | 0.16 | 0.09 | 300 | 600 | 0.50 ±0.05 |
| HK 1005 3N3-T | RoHS | 3.3 | ±0.3nH | 8 | 100 | 10 | 18 | 24 | 31 | 35 | 6000 | 8000 | 0.16 | 0.10 | 300 | 550 | 0.50 ±0.05 |
| HK 1005 3N6-T | RoHS | 3.6 | ±0.3nH | 8 | 100 | 10 | 18 | 24 | 31 | 35 | 5000 | 7500 | 0.20 | 0.11 | 300 | 500 | 0.50 ±0.05 |
| HK 1005 3N9-T | RoHS | 3.9 | ±0.3nH | 8 | 100 | 10 | 18 | 24 | 31 | 35 | 4000 | 7000 | 0.21 | 0.12 | 300 | 500 | 0.50 ±0.05 |
| HK 1005 4N3-T | RoHS | 4.3 | ±0.3nH | 8 | 100 | 10 | 18 | 24 | 31 | 35 | 4000 | 6500 | 0.20 | 0.12 | 300 | 500 | 0.50 ±0.05 |
| HK 1005 4N7-T | RoHS | 4.7 | ±0.3nH | 8 | 100 | 10 | 18 | 24 | 31 | 34 | 4000 | 6000 | 0.21 | 0.12 | 300 | 500 | 0.50 ±0.05 |
| HK 1005 5N1-T | RoHS | 5.1 | ±0.3nH | 8 | 100 | 10 | 18 | 24 | 31 | 34 | 4000 | 5800 | 0.21 | 0.13 | 300 | 450 | 0.50 ±0.05 |
| HK 1005 5N6-T | RoHS | 5.6 | ±0.3nH | 8 | 100 | 10 | 18 | 24 | 30 | 35 | 4000 | 5700 | 0.23 | 0.15 | 300 | 430 | 0.50 ±0.05 |
| HK 1005 6N2-T | RoHS | 6.2 | ±0.3nH | 8 | 100 | 10 | 18 | 24 | 30 | 34 | 3900 | 5600 | 0.25 | 0.16 | 300 | 430 | 0.50 ±0.05 |
| HK 1005 6N8-T | RoHS | 6.8 | ±5% | 8 | 100 | 10 | 18 | 23 | 29 | 32 | 3900 | 5500 | 0.25 | 0.17 | 300 | 430 | 0.50 ±0.05 |
| HK 1005 7N5-T | RoHS | 7.5 | ±5% | 8 | 100 | 10 | 18 | 23 | 29 | 32 | 3700 | 5200 | 0.25 | 0.18 | 300 | 400 | 0.50 ±0.05 |
| HK 1005 8N2-T | RoHS | 8.2 | ±5% | 8 | 100 | 10 | 18 | 23 | 29 | 31 | 3600 | 4900 | 0.28 | 0.21 | 300 | 380 | 0.50 ±0.05 |
| HK 1005 9N1-T | RoHS | 9.1 | ±5% | 8 | 100 | 10 | 18 | 23 | 29 | 31 | 3400 | 4500 | 0.30 | 0.22 | 300 | 360 | 0.50 ±0.05 |
| HK 1005 10N-T | RoHS | 10 | ±5% | 8 | 100 | 10 | 18 | 23 | 29 | 31 | 3200 | 4300 | 0.31 | 0.23 | 300 | 340 | 0.50 ±0.05 |
| HK 1005 12N-T | RoHS | 12 | ±5% | 8 | 100 | 11 | 18 | 23 | 29 | 31 | 2700 | 3900 | 0.40 | 0.28 | 300 | 330 | 0.50 ±0.05 |
| HK 1005 15N-T | RoHS | 15 | ±5% | 8 | 100 | 11 | 18 | 23 | 28 | 30 | 2300 | 3500 | 0.46 | 0.31 | 300 | 320 | 0.50 ±0.05 |
| HK 1005 18N-T | RoHS | 18 | ±5% | 8 | 100 | 11 | 18 | 23 | 28 | 30 | 2100 | 3100 | 0.55 | 0.35 | 300 | 310 | 0.50 ±0.05 |
| HK 1005 22N-T | RoHS | 22 | ±5% | 8 | 100 | 11 | 17 | 22 | 26 | 27 | 1900 | 2800 | 0.60 | 0.42 | 300 | 300 | 0.50 ±0.05 |
| HK 1005 27N-T | RoHS | 27 | ±5% | 8 | 100 | 11 | 17 | 21 | 25 | 26 | 1600 | 2300 | 0.70 | 0.47 | 300 | 300 | 0.50 ±0.05 |
| HK 1005 33N-T | RoHS | 33 | ±5% | 8 | 100 | 11 | 16 | 20 | 23 | 22 | 1300 | 1900 | 0.80 | 0.50 | 200 | 250 | 0.50 ±0.05 |
| HK 1005 39N-T | RoHS | 39 | ±5% | 8 | 100 | 11 | 16 | 20 | 23 | 21 | 1200 | 1700 | 0.90 | 0.52 | 200 | 250 | 0.50 ±0.05 |
| HK 1005 47N-T | RoHS | 47 | ±5% | 8 | 100 | 11 | 16 | 19 | 21 | 18 | 1000 | 1500 | 1.00 | 0.58 | 200 | 230 | 0.50 ±0.05 |
| HK 1005 56N-T | RoHS | 56 | ±5% | 8 | 100 | 11 | 16 | 18 | 18 | 16 | 750 | 1300 | 1.00 | 0.61 | 200 | 220 | 0.50 ±0.05 |
| HK 1005 68N-T | RoHS | 68 | ±5% | 8 | 100 | 11 | 15 | 17 | 18 | 11 | 750 | 1200 | 1.20 | 0.70 | 180 | 200 | 0.50 ±0.05 |
| HK 1005 82N-T | RoHS | 82 | ±5% | 8 | 100 | 10 | 14 | 16 | 15 | 6 | 600 | 1100 | 1.30 | 0.81 | 150 | 200 | 0.50 ±0.05 |
| HK 1005 R10-T | RoHS | 100 | ±5% | 8 | 100 | 10 | 14 | 14 | 12 | - | 600 | 1000 | 1.50 | 0.94 | 150 | 200 | 0.50 ±0.05 |
| HK 1005 R12-T | RoHS | 120 | ±5% | 8 | 100 | 10 | 12 | 10 | - | - | 600 | 800 | 1.60 | 1.10 | 150 | 200 | 0.50 ±0.05 |
| HK 1005 R15-T | RoHS | 150 | ±5% | 8 | 100 | 12 | 17 | 17 | - | - | 550 | 920 | 3.20 | 2.57 | 140 | 200 | 0.50 ±0.05 |
| HK 1005 R18-T | RoHS | 180 | ±5% | 8 | 100 | 12 | 16 | - | - | - | 500 | 810 | 3.70 | 2.97 | 130 | 200 | 0.50 ±0.05 |
| HK 1005 R22-T | RoHS | 220 | ±5% | 8 | 100 | 12 | 16 | - | - | - | 450 | 700 | 4.20 | 3.29 | 120 | 200 | 0.50 ±0.05 |
| HK 1005 R27-T | RoHS | 270 | ±5% | 8 | 100 | 12 | 14 | - | - | - | 400 | 600 | 4.80 | 3.92 | 110 | 200 | 0.50 ±0.05 |

※ □ mark indicates the Inductance tolerance code. Please refer for the inductance tolerance except the above.

HK 1608

| Parts number | EHS | Nominal inductance [nH] | Inductance tolerance ※ | Q (min.) | LQ Measuring frequency [MHz] | Q (Typical) frequency [MHz] | | | | | Self-resonant frequency [MHz] | | DC Resistance [Ω] | | Rated current [mA] (max.) | Thickness [mm] |
|---------------|------|-------------------------|------------------------|----------|------------------------------|-----------------------------|-----|-----|-----|------|-------------------------------|---------|-------------------|--------|---------------------------|----------------|
| | | | | | | 100 | 300 | 500 | 800 | 1000 | (min.) | (typ.) | (max.) | (typ.) | | |
| HK 1608 1N0-T | RoHS | 1.0 | ±0.3nH | 8 | 100 | 14 | 30 | 40 | 70 | 90 | 10000 | > 13000 | 0.05 | 0.015 | 300 | 0.80 ±0.15 |
| HK 1608 1N2-T | RoHS | 1.2 | ±0.3nH | 8 | 100 | 14 | 30 | 40 | 70 | 90 | 10000 | > 13000 | 0.05 | 0.015 | 300 | 0.80 ±0.15 |
| HK 1608 1N5-T | RoHS | 1.5 | ±0.3nH | 8 | 100 | 14 | 26 | 34 | 47 | 50 | 6000 | > 13000 | 0.10 | 0.03 | 300 | 0.80 ±0.15 |
| HK 1608 1N8-T | RoHS | 1.8 | ±0.3nH | 8 | 100 | 10 | 18 | 24 | 30 | 34 | 6000 | > 13000 | 0.10 | 0.06 | 300 | 0.80 ±0.15 |
| HK 1608 2N2-T | RoHS | 2.2 | ±0.3nH | 8 | 100 | 12 | 22 | 29 | 37 | 40 | 6000 | 12000 | 0.10 | 0.06 | 300 | 0.80 ±0.15 |
| HK 1608 2N7-T | RoHS | 2.7 | ±0.3nH | 10 | 100 | 13 | 24 | 32 | 41 | 45 | 6000 | 11000 | 0.10 | 0.06 | 300 | 0.80 ±0.15 |
| HK 1608 3N3-T | RoHS | 3.3 | ±0.3nH | 10 | 100 | 14 | 25 | 33 | 42 | 47 | 6000 | 9000 | 0.12 | 0.06 | 300 | 0.80 ±0.15 |
| HK 1608 3N9-T | RoHS | 3.9 | ±0.3nH | 10 | 100 | 13 | 25 | 33 | 42 | 46 | 6000 | 8000 | 0.14 | 0.07 | 300 | 0.80 ±0.15 |
| HK 1608 4N7-T | RoHS | 4.7 | ±0.3nH | 10 | 100 | 13 | 25 | 33 | 42 | 47 | 4000 | 6500 | 0.16 | 0.08 | 300 | 0.80 ±0.15 |
| HK 1608 5N6-T | RoHS | 5.6 | ±0.3nH | 10 | 100 | 14 | 25 | 33 | 42 | 46 | 4000 | 5800 | 0.18 | 0.09 | 300 | 0.80 ±0.15 |
| HK 1608 6N8-T | RoHS | 6.8 | ±5% | 10 | 100 | 14 | 25 | 33 | 43 | 47 | 4000 | 5600 | 0.22 | 0.11 | 300 | 0.80 ±0.15 |
| HK 1608 8N2-T | RoHS | 8.2 | ±5% | 10 | 100 | 14 | 26 | 34 | 44 | 48 | 3500 | 5200 | 0.24 | 0.13 | 300 | 0.80 ±0.15 |
| HK 1608 10N-T | RoHS | 10 | ±5% | 12 | 100 | 14 | 26 | 34 | 43 | 47 | 3400 | 4600 | 0.26 | 0.16 | 300 | 0.80 ±0.15 |
| HK 1608 12N-T | RoHS | 12 | ±5% | 12 | 100 | 14 | 27 | 35 | 45 | 49 | 2600 | 4000 | 0.28 | 0.17 | 300 | 0.80 ±0.15 |
| HK 1608 15N-T | RoHS | 15 | ±5% | 12 | 100 | 15 | 28 | 37 | 46 | 51 | 2300 | 3400 | 0.32 | 0.20 | 300 | 0.80 ±0.15 |
| HK 1608 18N-T | RoHS | 18 | ±5% | 12 | 100 | 15 | 27 | 36 | 44 | 48 | 2000 | 3000 | 0.35 | 0.21 | 300 | 0.80 ±0.15 |
| HK 1608 22N-T | RoHS | 22 | ±5% | 12 | 100 | 16 | 28 | 36 | 44 | 47 | 1600 | 2900 | 0.40 | 0.25 | 300 | 0.80 ±0.15 |
| HK 1608 27N-T | RoHS | 27 | ±5% | 12 | 100 | 16 | 29 | 37 | 45 | 46 | 1400 | 2200 | 0.45 | 0.28 | 300 | 0.80 ±0.15 |
| HK 1608 33N-T | RoHS | 33 | ±5% | 12 | 100 | 17 | 31 | 40 | 46 | 47 | 1200 | 1800 | 0.55 | 0.35 | 300 | 0.80 ±0.15 |
| HK 1608 39N-T | RoHS | 39 | ±5% | 12 | 100 | 18 | 31 | 39 | 44 | 44 | 1100 | 1600 | 0.60 | 0.38 | 300 | 0.80 ±0.15 |
| HK 1608 47N-T | RoHS | 47 | ±5% | 12 | 100 | 17 | 28 | 34 | 35 | 34 | 900 | 1600 | 0.70 | 0.45 | 300 | 0.80 ±0.15 |
| HK 1608 56N-T | RoHS | 56 | ±5% | 12 | 100 | 17 | 28 | 34 | 34 | 31 | 900 | 1400 | 0.75 | 0.50 | 300 | 0.80 ±0.15 |
| HK 1608 68N-T | RoHS | 68 | ±5% | 12 | 100 | 18 | 29 | 34 | 30 | 22 | 700 | 1200 | 0.85 | 0.55 | 300 | 0.80 ±0.15 |
| HK 1608 82N-T | RoHS | 82 | ±5% | 12 | 100 | 18 | 28 | 33 | 27 | - | 600 | 1100 | 0.95 | 0.60 | 300 | 0.80 ±0.15 |
| HK 1608 R10-T | RoHS | 100 | ±5% | 12 | 100 | 18 | 27 | 28 | 16 | - | 600 | 1000 | 1.00 | 0.65 | 300 | 0.80 ±0.15 |
| HK 1608 R12-T | RoHS | 120 | ±5% | 8 | 50 | 16 | 24 | 23 | - | - | 500 | 800 | 1.20 | 0.68 | 300 | 0.80 ±0.15 |
| HK 1608 R15-T | RoHS | 150 | ±5% | 8 | 50 | 13 | 19 | 16 | - | - | 500 | 800 | 1.20 | 0.73 | 300 | 0.80 ±0.15 |
| HK 1608 R18-T | RoHS | 180 | ±5% | 8 | 50 | 13 | 18 | 12 | - | - | 400 | 700 | 1.30 | 0.85 | 300 | 0.80 ±0.15 |
| HK 1608 R22-T | RoHS | 220 | ±5% | 8 | 50 | 12 | 16 | - | - | - | 400 | 600 | 1.50 | 0.95 | 300 | 0.80 ±0.15 |
| HK 1608 R27-T | RoHS | 270 | ±5% | 8 | 50 | 14 | 15 | - | - | - | 400 | 550 | 1.90 | 1.34 | 150 | 0.80 ±0.15 |
| HK 1608 R33-T | RoHS | 330 | ±5% | 8 | 50 | 14 | - | - | - | - | 350 | 480 | 2.10 | 1.53 | 150 | 0.80 ±0.15 |
| HK 1608 R39-T | RoHS | 390 | ±5% | 8 | 50 | 13 | - | - | - | - | 350 | 410 | 2.30 | 1.72 | 150 | 0.80 ±0.15 |
| HK 1608 R47-T | RoHS | 470 | ±5% | 8 | 50 | 13 | - | - | - | - | 300 | 360 | 2.60 | 2.04 | 150 | 0.80 ±0.15 |

※ □ mark indicates the Inductance tolerance code. Please refer for the inductance tolerance except the above.

▶ This catalog contains the typical specification only due to the limitation of space. When you consider the purchase of our products, please check our specification. For details of each product (characteristics graph, reliability information, precautions for use, and so on), see our Web site (<http://www.ty-top.com/>).

● HK 2125

| Parts number | EHS | Nominal inductance [nH] | Inductance tolerance | Q (min.) | LQ Measuring frequency [MHz] | Q (Typical) frequency [MHz] | | | | | Self-resonant frequency [MHz] | | DC Resistance [Ω] | | Rated current [mA] (max.) | Thickness [mm] |
|----------------|------|-------------------------|----------------------|----------|------------------------------|-----------------------------|-----|-----|-----|------|-------------------------------|--------|----------------------------|--------|---------------------------|----------------|
| | | | | | | 100 | 300 | 500 | 800 | 1000 | (min.) | (typ.) | (max.) | (typ.) | | |
| HK 2125 1N5S-T | RoHS | 1.5 | ± 0.3 nH | 10 | 100 | 21 | 39 | 57 | 61 | 68 | 4000 | > 6000 | 0.10 | 0.02 | 300 | 0.85 ± 0.2 |
| HK 2125 1N8S-T | RoHS | 1.8 | ± 0.3 nH | 10 | 100 | 18 | 35 | 49 | 55 | 59 | 4000 | > 6000 | 0.10 | 0.02 | 300 | 0.85 ± 0.2 |
| HK 2125 2N2S-T | RoHS | 2.2 | ± 0.3 nH | 10 | 100 | 18 | 33 | 46 | 53 | 58 | 4000 | > 6000 | 0.10 | 0.03 | 300 | 0.85 ± 0.2 |
| HK 2125 2N7S-T | RoHS | 2.7 | ± 0.3 nH | 12 | 100 | 19 | 36 | 50 | 56 | 60 | 4000 | > 6000 | 0.10 | 0.03 | 300 | 0.85 ± 0.2 |
| HK 2125 3N3S-T | RoHS | 3.3 | ± 0.3 nH | 12 | 100 | 16 | 29 | 40 | 47 | 51 | 4000 | > 6000 | 0.13 | 0.04 | 300 | 0.85 ± 0.2 |
| HK 2125 3N9S-T | RoHS | 3.9 | ± 0.3 nH | 12 | 100 | 18 | 33 | 46 | 54 | 60 | 4000 | > 6000 | 0.15 | 0.05 | 300 | 0.85 ± 0.2 |
| HK 2125 4N7S-T | RoHS | 4.7 | ± 0.3 nH | 12 | 100 | 18 | 34 | 46 | 55 | 60 | 3500 | > 6000 | 0.20 | 0.05 | 300 | 0.85 ± 0.2 |
| HK 2125 5N6S-T | RoHS | 5.6 | ± 0.3 nH | 15 | 100 | 20 | 38 | 51 | 60 | 66 | 3200 | 5400 | 0.23 | 0.05 | 300 | 0.85 ± 0.2 |
| HK 2125 6N8J-T | RoHS | 6.8 | $\pm 5\%$ | 15 | 100 | 20 | 39 | 52 | 63 | 69 | 2800 | 4200 | 0.25 | 0.06 | 300 | 0.85 ± 0.2 |
| HK 2125 8N2J-T | RoHS | 8.2 | $\pm 5\%$ | 15 | 100 | 21 | 40 | 54 | 63 | 70 | 2400 | 3700 | 0.28 | 0.07 | 300 | 0.85 ± 0.2 |
| HK 2125 10NJ-T | RoHS | 10 | $\pm 5\%$ | 15 | 100 | 20 | 38 | 51 | 60 | 67 | 2100 | 3100 | 0.30 | 0.09 | 300 | 0.85 ± 0.2 |
| HK 2125 12NJ-T | RoHS | 12 | $\pm 5\%$ | 15 | 100 | 21 | 39 | 52 | 60 | 67 | 1900 | 3000 | 0.35 | 0.10 | 300 | 0.85 ± 0.2 |
| HK 2125 15NJ-T | RoHS | 15 | $\pm 5\%$ | 15 | 100 | 22 | 42 | 55 | 63 | 72 | 1600 | 2600 | 0.40 | 0.11 | 300 | 0.85 ± 0.2 |
| HK 2125 18NJ-T | RoHS | 18 | $\pm 5\%$ | 15 | 100 | 24 | 44 | 57 | 63 | 72 | 1500 | 2300 | 0.45 | 0.13 | 300 | 0.85 ± 0.2 |
| HK 2125 22NJ-T | RoHS | 22 | $\pm 5\%$ | 18 | 100 | 23 | 43 | 55 | 60 | 69 | 1400 | 2100 | 0.50 | 0.16 | 300 | 0.85 ± 0.2 |
| HK 2125 27NJ-T | RoHS | 27 | $\pm 5\%$ | 18 | 100 | 23 | 42 | 53 | 58 | 68 | 1300 | 1800 | 0.55 | 0.17 | 300 | 0.85 ± 0.2 |
| HK 2125 33NJ-T | RoHS | 33 | $\pm 5\%$ | 18 | 100 | 24 | 43 | 54 | 55 | 60 | 1200 | 1700 | 0.60 | 0.19 | 300 | 0.85 ± 0.2 |
| HK 2125 39NJ-T | RoHS | 39 | $\pm 5\%$ | 18 | 100 | 23 | 41 | 50 | 47 | 47 | 1000 | 1400 | 0.65 | 0.25 | 300 | 0.85 ± 0.2 |
| HK 2125 47NJ-T | RoHS | 47 | $\pm 5\%$ | 18 | 100 | 23 | 41 | 49 | 43 | 41 | 900 | 1200 | 0.70 | 0.26 | 300 | 1.00 +0.2/-0.3 |
| HK 2125 56NJ-T | RoHS | 56 | $\pm 5\%$ | 18 | 100 | 23 | 42 | 48 | 39 | 38 | 800 | 1100 | 0.75 | 0.28 | 300 | 1.00 +0.2/-0.3 |
| HK 2125 68NJ-T | RoHS | 68 | $\pm 5\%$ | 18 | 100 | 25 | 42 | 45 | 30 | — | 700 | 900 | 0.80 | 0.33 | 300 | 1.00 +0.2/-0.3 |
| HK 2125 82NJ-T | RoHS | 82 | $\pm 5\%$ | 18 | 100 | 24 | 41 | 41 | — | — | 600 | 800 | 0.90 | 0.37 | 300 | 1.00 +0.2/-0.3 |
| HK 2125 R10J-T | RoHS | 100 | $\pm 5\%$ | 18 | 100 | 23 | 37 | 37 | — | — | 600 | 800 | 0.90 | 0.40 | 300 | 1.00 +0.2/-0.3 |
| HK 2125 R12J-T | RoHS | 120 | $\pm 5\%$ | 13 | 50 | 22 | 33 | 29 | — | — | 500 | 700 | 0.95 | 0.43 | 300 | 1.00 +0.2/-0.3 |
| HK 2125 R15J-T | RoHS | 150 | $\pm 5\%$ | 13 | 50 | 22 | 34 | 26 | — | — | 500 | 700 | 1.00 | 0.46 | 300 | 1.00 +0.2/-0.3 |
| HK 2125 R18J-T | RoHS | 180 | $\pm 5\%$ | 13 | 50 | 23 | 34 | 20 | — | — | 400 | 600 | 1.10 | 0.50 | 300 | 1.00 +0.2/-0.3 |
| HK 2125 R22J-T | RoHS | 220 | $\pm 5\%$ | 12 | 50 | 20 | 23 | — | — | — | 350 | 550 | 1.20 | 0.75 | 300 | 1.00 +0.2/-0.3 |
| HK 2125 R27J-T | RoHS | 270 | $\pm 5\%$ | 12 | 50 | 20 | 29 | — | — | — | 300 | 480 | 1.30 | 0.85 | 300 | 1.00 +0.2/-0.3 |
| HK 2125 R33J-T | RoHS | 330 | $\pm 5\%$ | 12 | 50 | 22 | 15 | — | — | — | 250 | 400 | 1.40 | 0.90 | 300 | 1.00 +0.2/-0.3 |
| HK 2125 R39J-T | RoHS | 390 | $\pm 5\%$ | 10 | 50 | 17 | 12 | — | — | — | 250 | 400 | 1.30 | 0.85 | 300 | 1.00 +0.2/-0.3 |
| HK 2125 R47J-T | RoHS | 470 | $\pm 5\%$ | 10 | 50 | 17 | — | — | — | — | 200 | 350 | 1.50 | 0.95 | 300 | 1.00 +0.2/-0.3 |

※ □ mark indicates the Inductance tolerance code. Please refer for the inductance tolerance except the above.

Multilayer chip inductors

Multilayer chip inductors for high frequency, Multilayer chip bead inductors

Multilayer common mode choke coils (MC series F type)

PACKAGING

① Minimum Quantity

● Tape & Reel Packaging

| Type | Thickness mm (inch) | Standard Quantity [pcs] | |
|----------------|------------------------|-------------------------|---------------|
| | | Paper Tape | Embossed Tape |
| CK1608(0603) | 0.8 (0.031) | 4000 | — |
| CK2125(0805) | 0.85(0.033) | 4000 | — |
| | 1.25(0.049) | — | 2000 |
| CKS2125(0805) | 0.85(0.033) | 4000 | — |
| | 1.25(0.049) | — | 2000 |
| CKP1608(0603) | 0.8 (0.031) | 4000 | — |
| CKP2012(0805) | 0.9 (0.035) | — | 3000 |
| CKP2016(0806) | 0.9 (0.035) | — | 3000 |
| CKP2520(1008) | 0.7 (0.028) | — | 3000 |
| | 0.9 (0.035) | — | 3000 |
| | 1.1 (0.043) | — | 2000 |
| NM2012(0805) | 0.9 (0.035) | — | 3000 |
| NM2520(1008) | 0.9 (0.035) | — | 3000 |
| | 1.1 (0.043) | — | 2000 |
| LK1005(0402) | 0.5 (0.020) | 10000 | — |
| LK1608(0603) | 0.8 (0.031) | 4000 | — |
| LK2125(0805) | 0.85(0.033) | 4000 | — |
| | 1.25(0.049) | — | 2000 |
| HK0402(01005) | 0.2 (0.008) | 20000 | — |
| HK0603(0201) | 0.3 (0.012) | 15000 | — |
| HK1005(0402) | 0.5 (0.020) | 10000 | — |
| HK1608(0603) | 0.8 (0.031) | 4000 | — |
| HK2125(0805) | 0.85(0.033) | — | 4000 |
| | 1.0 (0.039) | — | 3000 |
| HKQ0402(01005) | 0.2 (0.008) | 20000 | 40000 |
| HKQ0603W(0201) | 0.3 (0.012) | 15000 | — |
| HKQ0603C(0201) | 0.3 (0.012) | 15000 | — |
| HKQ0603S(0201) | 0.3 (0.012) | 15000 | — |
| HKQ0603U(0201) | 0.3 (0.012) | 15000 | — |
| AQ105(0402) | 0.5 (0.020) | 10000 | — |
| BK0402(01005) | 0.2 (0.008) | 20000 | — |
| BK0603(0201) | 0.3 (0.012) | 15000 | — |
| BK1005(0402) | 0.5 (0.020) | 10000 | — |
| BKH0603(0201) | 0.3 (0.012) | 15000 | — |
| BKH1005(0402) | 0.5 (0.020) | 10000 | — |
| BK1608(0603) | 0.8 (0.031) | 4000 | — |
| BK2125(0805) | 0.85(0.033) | 4000 | — |
| | 1.25(0.049) | — | 2000 |
| BK2010(0804) | 0.45(0.018) | 4000 | — |
| BK3216(1206) | 0.8 (0.031) | — | 4000 |
| BKP0402(01005) | 0.2 (0.008) | 20000 | — |
| BKP0603(0201) | 0.3 (0.012) | 15000 | — |
| BKP1005(0402) | 0.5 (0.020) | 10000 | — |
| BKP1608(0603) | 0.8 (0.031) | 4000 | — |
| BKP2125(0805) | 0.85(0.033) | 4000 | — |
| MCF0605(0202) | 0.3 (0.012) | 15000 | — |
| MCF0806(0302) | 0.4 (0.016) | — | 10000 |
| MCF1210(0504) | 0.55(0.022) | — | 5000 |
| MCF2010(0804) | 0.45(0.018) | — | 4000 |

▶ This catalog contains the typical specification only due to the limitation of space. When you consider the purchase of our products, please check our specification. For details of each product (characteristics graph, reliability information, precautions for use, and so on), see our Web site (<http://www.ty-top.com/>).

② Taping material

● Card board carrier tape

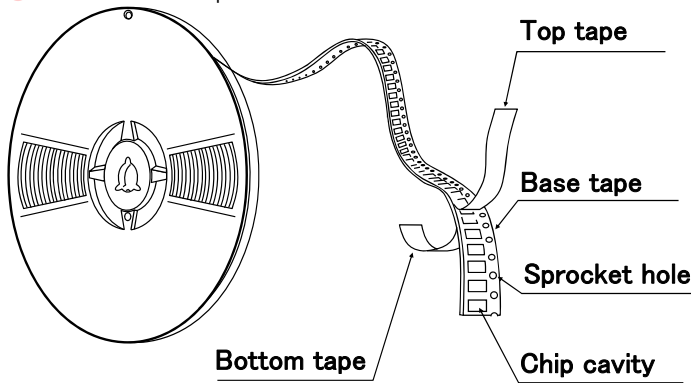

| | |
|-----|------|
| CK | 1608 |
| CKP | 1608 |
| CK | 2125 |
| CKS | 2125 |
| LK | 1005 |
| LK | 1608 |
| LK | 2125 |
| HK | 0402 |
| HK | 0603 |
| HK | 1005 |
| HK | 1608 |
| HKQ | 0402 |
| HKQ | 0603 |
| AQ | 105 |

| | |
|-----|------|
| BK | 0402 |
| BK | 0603 |
| BK | 1005 |
| BK | 1608 |
| BK | 2125 |
| BK | 2010 |
| BKP | 0402 |
| BKP | 0603 |
| BKP | 1005 |
| BKP | 1608 |
| BKP | 2125 |
| BKH | 0603 |
| BKH | 1005 |
| MCF | 0605 |

Chip Filled

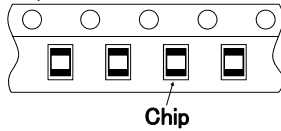

● Embossed Tape

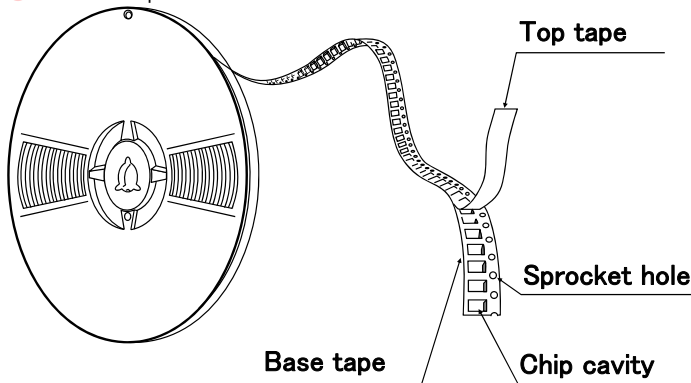

| | |
|-----|------|
| CK | 2125 |
| CKS | 2125 |
| CKP | 2012 |
| CKP | 2016 |
| CKP | 2520 |
| NM | 2012 |
| NM | 2520 |
| LK | 2125 |
| HKQ | 0402 |
| HK | 2125 |

| | |
|-----|------|
| BK | 2125 |
| BK | 3216 |
| MCF | 0806 |
| MCF | 1210 |
| MCF | 2010 |

Chip Filled

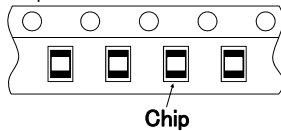

③ Taping Dimensions

● Paper tape (8mm wide)

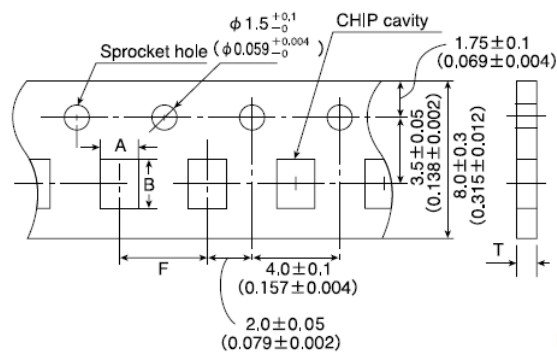

► This catalog contains the typical specification only due to the limitation of space. When you consider the purchase of our products, please check our specification. For details of each product (characteristics graph, reliability information, precautions for use, and so on), see our Web site (<http://www.ty-top.com/>).

| Type | Thickness mm (inch) | Chip cavity | | Insertion Pitch | Tape Thickness |
|----------------|------------------------|----------------------------|----------------------------|---------------------------|-----------------------|
| | | A | B | F | T |
| CK1608(0603) | 0.8 (0.031) | 1.0±0.2 (0.039±0.008) | 1.8±0.2 (0.071±0.008) | 4.0±0.1 (0.157±0.004) | 1.1max (0.043max) |
| CK2125(0805) | 0.85(0.033) | 1.5±0.2 (0.059±0.008) | 2.3±0.2 (0.091±0.008) | 4.0±0.1 (0.157±0.004) | 1.1max (0.043max) |
| CKS2125(0805) | 0.85(0.033) | 1.5±0.2 (0.059±0.008) | 2.3±0.2 (0.091±0.008) | 4.0±0.1 (0.157±0.004) | 1.1max (0.043max) |
| CKP1608(0603) | 0.8 (0.031) | 1.0±0.2 (0.039±0.008) | 1.8±0.2 (0.071±0.008) | 4.0±0.1 (0.157±0.004) | 1.1max (0.043max) |
| LK1005(0402) | 0.5 (0.020) | 0.65±0.1 (0.026±0.004) | 1.15±0.1 (0.045±0.004) | 2.0±0.05 (0.079±0.002) | 0.8max (0.031max) |
| LK1608(0603) | 0.8 (0.031) | 1.0±0.2 (0.039±0.008) | 1.8±0.2 (0.071±0.008) | 4.0±0.1 (0.157±0.004) | 1.1max (0.043max) |
| LK2125(0805) | 0.85(0.033) | 1.5±0.2 (0.059±0.008) | 2.3±0.2 (0.091±0.008) | 4.0±0.1 (0.157±0.004) | 1.1max (0.043max) |
| HK0402(01005) | 0.2 (0.008) | 0.25±0.04 (0.010±0.002) | 0.45±0.04 (0.018±0.002) | 2.0±0.05 (0.079±0.002) | 0.36max (0.014max) |
| HK0603(0201) | 0.3 (0.012) | 0.40±0.06 (0.016±0.002) | 0.70±0.06 (0.028±0.002) | 2.0±0.05 (0.079±0.002) | 0.45max (0.018max) |
| HK1005(0402) | 0.5 (0.020) | 0.65±0.1 (0.026±0.004) | 1.15±0.1 (0.045±0.004) | 2.0±0.05 (0.079±0.002) | 0.8max (0.031max) |
| HK1608(0603) | 0.8 (0.031) | 1.0±0.2 (0.039±0.008) | 1.8±0.2 (0.071±0.008) | 4.0±0.1 (0.157±0.004) | 1.1max (0.043max) |
| HKQ0402(01005) | 0.2 (0.008) | 0.25±0.04 (0.010±0.002) | 0.45±0.04 (0.018±0.002) | 2.0±0.05 (0.079±0.002) | 0.36max (0.014max) |
| HKQ0603W(0201) | 0.3 (0.012) | 0.40±0.06 (0.016±0.002) | 0.70±0.06 (0.028±0.002) | 2.0±0.05 (0.079±0.002) | 0.45max (0.018max) |
| HKQ0603C(0201) | 0.3 (0.012) | 0.40±0.06 (0.016±0.002) | 0.70±0.06 (0.028±0.002) | 2.0±0.05 (0.079±0.002) | 0.45max (0.018max) |
| HKQ0603S(0201) | 0.3 (0.012) | 0.40±0.06 (0.016±0.002) | 0.70±0.06 (0.028±0.002) | 2.0±0.05 (0.079±0.002) | 0.45max (0.018max) |
| HKQ0603U(0201) | 0.3 (0.012) | 0.40±0.06 (0.016±0.002) | 0.70±0.06 (0.028±0.002) | 2.0±0.05 (0.079±0.002) | 0.45max (0.018max) |
| AQ105(0402) | 0.5 (0.020) | 0.75±0.1 (0.030±0.004) | 1.15±0.1 (0.045±0.004) | 2.0±0.05 (0.079±0.002) | 0.8max (0.031max) |
| BK0402(01005) | 0.2 (0.008) | 0.25±0.04 (0.010±0.002) | 0.45±0.04 (0.018±0.002) | 2.0±0.05 (0.079±0.002) | 0.36max (0.014max) |
| BK0603(0201) | 0.3 (0.012) | 0.40±0.06 (0.016±0.002) | 0.70±0.06 (0.028±0.002) | 2.0±0.05 (0.079±0.002) | 0.45max (0.018max) |
| BK1005(0402) | 0.5 (0.020) | 0.65±0.1 (0.026±0.004) | 1.15±0.1 (0.045±0.004) | 2.0±0.05 (0.079±0.002) | 0.8max (0.031max) |
| BK1608(0603) | 0.8 (0.031) | 1.0±0.2 (0.039±0.008) | 1.8±0.2 (0.071±0.008) | 4.0±0.1 (0.157±0.004) | 1.1max (0.043max) |
| BK2125(0805) | 0.85(0.033) | 1.5±0.2 (0.059±0.008) | 2.3±0.2 (0.091±0.008) | 4.0±0.1 (0.157±0.004) | 1.1max (0.043max) |
| BK2010(0804) | 0.45(0.018) | 1.2±0.1 (0.047±0.004) | 2.17±0.1 (0.085±0.004) | 4.0±0.1 (0.157±0.004) | 0.8max (0.031max) |
| BKP0402(01005) | 0.2 (0.008) | 0.25±0.04 (0.010±0.002) | 0.45±0.04 (0.018±0.002) | 2.0±0.05 (0.079±0.002) | 0.36max (0.014max) |
| BKP0603(0201) | 0.3 (0.012) | 0.40±0.06 (0.016±0.002) | 0.70±0.06 (0.028±0.002) | 2.0±0.05 (0.079±0.002) | 0.45max (0.018max) |
| BKP1005(0402) | 0.5 (0.020) | 0.65±0.1 (0.026±0.004) | 1.15±0.1 (0.045±0.004) | 2.0±0.05 (0.079±0.002) | 0.8max (0.031max) |
| BKP1608(0603) | 0.8 (0.031) | 1.0±0.2 (0.039±0.008) | 1.8±0.2 (0.071±0.008) | 4.0±0.1 (0.157±0.004) | 1.1max (0.043max) |
| BKP2125(0805) | 0.85(0.033) | 1.5±0.2 (0.059±0.008) | 2.3±0.2 (0.091±0.008) | 4.0±0.1 (0.157±0.004) | 1.1max (0.043max) |
| BKH0603(0201) | 0.3 (0.012) | 0.40±0.06 (0.016±0.002) | 0.70±0.06 (0.028±0.002) | 2.0±0.05 (0.079±0.002) | 0.45max (0.018max) |
| BKH1005(0402) | 0.5 (0.020) | 0.65±0.1 (0.026±0.004) | 1.15±0.1 (0.045±0.004) | 2.0±0.05 (0.079±0.002) | 0.8max (0.031max) |
| MCF0605(0202) | 0.3 (0.012) | 0.62±0.03 (0.024±0.001) | 0.77±0.03 (0.030±0.001) | 2.0±0.05 (0.079±0.002) | 0.45max (0.018max) |

Unit : mm (inch)

● Embossed Tape (8mm wide)

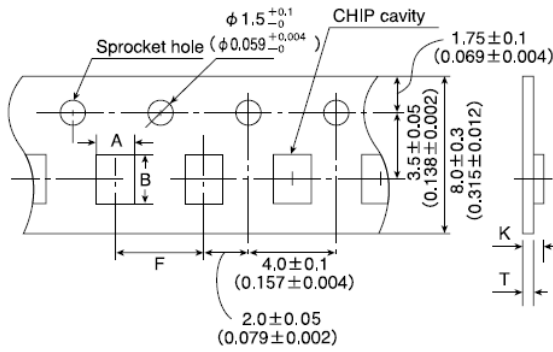

Unit : mm (inch)

| Type | Thickness mm (inch) | Chip cavity | | Insertion Pitch F | Tape Thickness | |
|---------------|------------------------|----------------------------|----------------------------|---------------------------|-----------------|----------------|
| | | A | B | | K | T |
| CK2125(0805) | 1.25(0.049) | 1.5±0.2 (0.059±0.008) | 2.3±0.2 (0.091±0.008) | 4.0±0.1 (0.157±0.004) | 2.0 (0.079) | 0.3 (0.012) |
| CKS2125(0805) | 1.25(0.049) | 1.5±0.2 (0.059±0.008) | 2.3±0.2 (0.091±0.008) | 4.0±0.1 (0.157±0.004) | 2.0 (0.079) | 0.3 (0.012) |
| CKP2012(0805) | 0.9 (0.035) | 1.55±0.2 (0.061±0.008) | 2.3±0.2 (0.091±0.008) | 4.0±0.1 (0.157±0.004) | 1.3 (0.051) | 0.3 (0.012) |
| CKP2016(0806) | 0.9 (0.035) | 1.8±0.1 (0.071±0.004) | 2.2±0.1 (0.087±0.004) | 4.0±0.1 (0.157±0.004) | 1.3 (0.051) | 0.25 (0.01) |
| CKP2520(1008) | 0.7 (0.028) | 2.3±0.1 (0.091±0.004) | 2.8±0.1 (0.110±0.004) | 4.0±0.1 (0.157±0.004) | 1.4 (0.055) | 0.3 (0.012) |
| | 0.9 (0.035) | | | | 1.4 (0.055) | |
| | 1.1 (0.043) | | | | 1.7 (0.067) | |
| NM2012(0805) | 0.9 (0.035) | 1.55±0.2 (0.061±0.008) | 2.3±0.2 (0.091±0.008) | 4.0±0.1 (0.157±0.004) | 1.3 (0.051) | 0.3 (0.012) |
| NM2520(1008) | 0.9 (0.035) | 2.3±0.1 (0.091±0.004) | 2.8±0.1 (0.110±0.004) | 4.0±0.1 (0.157±0.004) | 1.4 (0.055) | 0.3 (0.012) |
| | 1.1 (0.043) | | | | 1.7 (0.067) | |
| LK2125(0805) | 1.25(0.049) | 1.5±0.2 (0.059±0.008) | 2.3±0.2 (0.091±0.008) | 4.0±0.1 (0.157±0.004) | 2.0 (0.079) | 0.3 (0.012) |
| HK2125(0805) | 0.85(0.033) | 1.5±0.2 (0.059±0.008) | 2.3±0.2 (0.091±0.008) | 4.0±0.1 (0.157±0.004) | 1.5 (0.059) | 0.3 (0.012) |
| | 1.0 (0.039) | | | | 2.0 (0.079) | |
| BK2125(0805) | 1.25(0.049) | 1.5±0.2 (0.059±0.008) | 2.3±0.2 (0.091±0.008) | 4.0±0.1 (0.157±0.004) | 2.0 (0.079) | 0.3 (0.012) |
| BK3216(1206) | 0.8(0.031) | 1.9±0.1 (0.075±0.004) | 3.5±0.1 (0.138±0.004) | 4.0±0.1 (0.157±0.004) | 1.4 (0.055) | 0.3 (0.012) |
| MCF0806(0302) | 0.4 (0.016) | 0.75±0.05 (0.030±0.002) | 0.95±0.05 (0.037±0.002) | 2.0±0.05 (0.079±0.002) | 0.55 (0.022) | 0.3 (0.012) |
| MCF1210(0504) | 0.55(0.022) | 1.15±0.05 (0.045±0.002) | 1.40±0.05 (0.055±0.002) | 4.0±0.1 (0.157±0.004) | 0.65 (0.026) | 0.3 (0.012) |
| MCF2010(0804) | 0.45(0.018) | 1.1±0.1 (0.043±0.004) | 2.3±0.1 (0.091±0.004) | 4.0±0.1 (0.157±0.004) | 0.85 (0.033) | 0.3 (0.012) |

Unit : mm (inch)

● Embossed Tape (4mm wide)

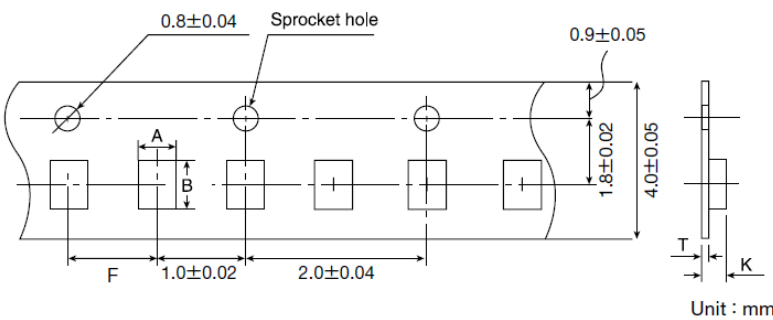

Unit : mm

| Type | Thickness mm (inch) | Chip cavity | | Insertion Pitch F | Tape Thickness | |
|----------------|------------------------|-------------|------|----------------------|----------------|----------|
| | | A | B | | K | T |
| HKQ0402(01005) | 0.2 (0.008) | 0.23 | 0.43 | 1.0±0.02 | 0.5max. | 0.25max. |

Unit : mm

▶ This catalog contains the typical specification only due to the limitation of space. When you consider the purchase of our products, please check our specification. For details of each product (characteristics graph, reliability information, precautions for use, and so on), see our Web site (<http://www.ty-top.com/>).

④ LEADER AND BLANK PORTION

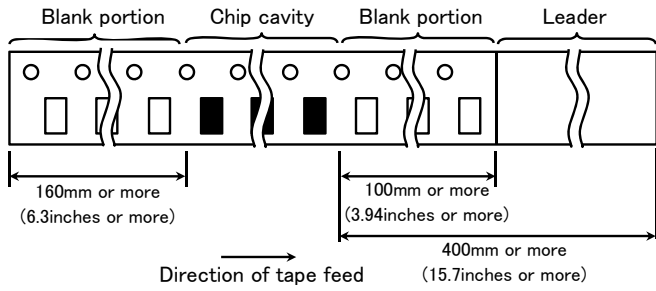

⑤ Reel Size

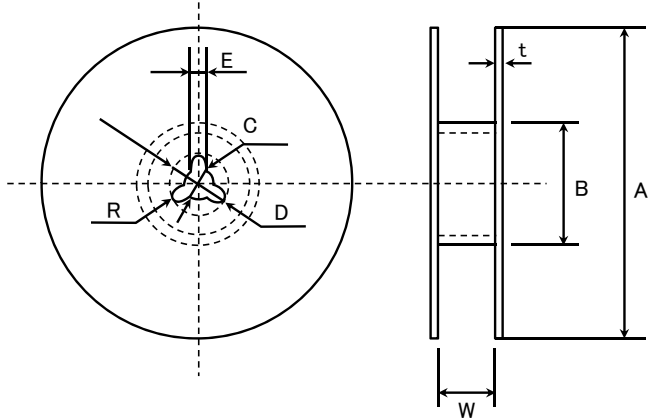

| A | B | C | D | E | R |
|--------------------|-------------------|---------------------|---------------------|---------------|-----|
| $\phi 178 \pm 2.0$ | $\phi 50$ or more | $\phi 13.0 \pm 0.2$ | $\phi 21.0 \pm 0.8$ | 2.0 ± 0.5 | 1.0 |

| | t | W |
|----------------|---------|--------------|
| 4mm width tape | 1.5max. | 5 ± 1.0 |
| 8mm width tape | 2.5max. | 10 ± 1.5 |

(Unit : mm)

⑥ Top tape strength

The top tape requires a peel-off force of 0.1~0.7N in the direction of the arrow as illustrated below.

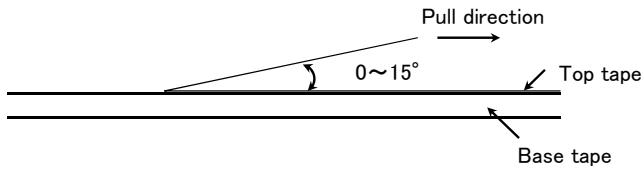

Multilayer chip inductors

Multilayer chip inductors for high frequency, Multilayer chip bead inductors

Multilayer common mode choke coils (MC series F type)

■ RELIABILITY DATA

| 1. Operating Temperature Range | | | |
|--|----------------|--------------|-------------|
| Specified Value | BK0402 | -55 ~ +125°C | |
| | BK0603 | | |
| | BK1005 | | |
| | BKH0603 | | |
| | BKH1005 | | |
| | BK1608 | | |
| | BK2125 | | |
| | ARRAY | | BK2010 |
| | | | BK3216 |
| | BKP0402 | | -55 ~ +85°C |
| | BKP0603 | | |
| | BKP1005 | | |
| | BKP1608 | | |
| | BKP2125 | | |
| | MCF 0605 | -40 ~ +85°C | |
| | MCF 0806 | | |
| | MCF 1210 | | |
| | MCF 2010 | | |
| | CK1608 | -40 ~ +85°C | |
| | CK2125 | | |
| | CKS2125 | | |
| | CKP1608 | | |
| | CKP2012 | | |
| | CKP2016 | | |
| | CKP2520 | | |
| | NM2012 | | |
| | NM2520 | | |
| | LK1005 | | |
| | LK1608 | | |
| | LK2125 | -55 ~ +125°C | |
| | HK0402/HKQ0402 | | |
| | HK0603 | | |
| HK1005 | -40 ~ +85°C | | |
| HK1608 | | | |
| HK2125 | -55 ~ +125°C | | |
| HKQ0603W/HKQ0603C/HKQ0603S/ HKQ0603U/ | | | |
| AQ105 | | | |

► This catalog contains the typical specification only due to the limitation of space. When you consider the purchase of our products, please check our specification.
For details of each product (characteristics graph, reliability information, precautions for use, and so on), see our Web site (<http://www.ty-top.com/>).

2. Storage Temperature Range

| | | | |
|--|--------------|--------------|--------|
| Specified Value | BK0402 | -55 ~ +125°C | |
| | BK0603 | | |
| | BK1005 | | |
| | BKH0603 | | |
| | BKH1005 | | |
| | BK1608 | | |
| | BK2125 | | |
| | ARRAY | | BK2010 |
| | | | BK3216 |
| | BKP0402 | -55 ~ +85°C | |
| | BKP0603 | | |
| | BKP1005 | | |
| | BKP1608 | | |
| | BKP2125 | | |
| | MCF 0605 | -40 ~ +85°C | |
| | MCF 0806 | | |
| | MCF 1210 | | |
| | MCF 2010 | | |
| | CK1608 | -40 ~ +85°C | |
| | CK2125 | | |
| | CKS2125 | | |
| | CKP1608 | | |
| | CKP2012 | | |
| | CKP2016 | | |
| | CKP2520 | | |
| NM2012 | | | |
| NM2520 | | | |
| LK1005 | | | |
| LK1608 | | | |
| LK2125 | | | |
| HK0402/HKQ0402 | -55 ~ +125°C | | |
| HK0603 | | | |
| HK1005 | | | |
| HK1608 | -40 ~ +85°C | | |
| HK2125 | | | |
| HKQ0603W/HKQ0603C/HKQ0603S/ HKQ0603U/ | -55 ~ +125°C | | |
| AQ105 | | | |

3. Rated Current

| | | | |
|-----------------|----------|--|--------------|
| Specified Value | BK0402 | 150~750mA DC | |
| | BK0603 | 100~500mA DC | |
| | BK1005 | 120~1000mA DC | |
| | BKH0603 | 115~160mA DC | |
| | BKH1005 | 200~300mA DC | |
| | BK1608 | 150~1500mA DC | |
| | BK2125 | 200~1200mA DC | |
| | ARRAY | BK2010 | 100mA DC |
| | | BK3216 | 100~200mA DC |
| | BKP0402 | 1.1A DC | |
| | BKP0603 | 0.8~1.8A DC | |
| | BKP1005 | 0.8~2.4A DC | |
| | BKP1608 | 1.0~3.0A DC | |
| | BKP2125 | 1.5~4.0A DC | |
| | MCF 0605 | 0.05A DC | |
| | MCF 0806 | 0.1~0.13A DC | |
| | MCF 1210 | 0.1~0.15A DC | |
| | MCF 2010 | 0.1A DC | |
| | CK1608 | 50~60mA DC | |
| | CK2125 | 60~500mA DC | |
| | CKS2125 | 110~280mA DC | |
| | CKP1608 | 0.35~0.9A DC | |
| | CKP2012 | 0.7~1.2A DC | |
| | CKP2016 | 0.9~1.6A DC | |
| | CKP2520 | 1.1~1.8A DC | |
| | NM2012 | 1.0~1.2A DC | |
| | NM2520 | 0.9~1.2A DC | |
| | LK1005 | 20~25mA DC | |
| | LK1608 | 1~150mA DC | |
| | LK2125 | 5~300mA DC | |
| | HK0402 | 160~380mA DC | |
| | HK0603 | 60~470mA DC | |
| | HK1005 | 110~300mA DC (-55~+125°C) 200~900mA DC (-55~+85°C) | |
| | HK1608 | 150~300mA DC | |
| | HK2125 | 300mA DC | |
| | HKQ0402 | 100~500mA DC | |
| | HKQ0603W | 100~850mA DC | |
| | HKQ0603C | 160~850mA DC | |
| | HKQ0603S | 130~600mA DC | |
| | HKQ0603U | 190~900mA DC | |
| | AQ105 | 280~710mA DC | |

Definition of rated current :

- In the CK, CKS and BK Series, the rated current is the value of current at which the temperature of the element is increased within 20°C.
- In the BK Series P type and CK Series P type, NM Series the rated current is the value of current at which the temperature of the element is increased within 40°C.
- In the LK, HK, HKQ0603, and AQ Series, the rated current is either the DC value at which the internal L value is decreased within 5% with the application of DC bias, or the value of current at which the temperature of the element is increased within 20°C.
- In the HKQ0402(~9N1), the rated current is either the DC value at which the internal L value is decreased within 5% with the application of DC bias, or the value of current at which the temperature of the element is increased within 20°C.
- In the HKQ0402(10N~), the rated current is either the DC value at which the internal L value is decreased within 5% with the application of DC bias, or the value of current at which the temperature of the element is increased within 25°C.

| 4. Impedance | | | |
|---|--|---|---------------|
| Specified Value | BK0402 | 10~180Ω ±5Ω(10Ω), ±25%(Other) | |
| | BK0603 | 10~600Ω ±25% | |
| | BK1005 | 10~1800Ω ±25% | |
| | BKH0603 | 600~1500Ω ±25% | |
| | BKH1005 | 600~1800Ω ±25% | |
| | BK1608 | 22~2500Ω ±25% | |
| | BK2125 | 15~2500Ω ±25% | |
| | ARRAY | BK2010 | 5~1000Ω ±25% |
| | | BK3216 | 60~1000Ω ±25% |
| | BKP0402 | 10 ±5Ω | |
| | BKP0603 | 10~120Ω ±5Ω(10Ω), ±25%(Other) | |
| | BKP1005 | 10~330Ω ±5Ω(EM100), ±25%(Other) | |
| | BKP1608 | 33~470Ω ±25% | |
| | BKP2125 | 33~330Ω ±25% | |
| | MCF 0605 | 12~90Ω ±5Ω(12Ω), ±20%(35Ω), ±25%(Other) | |
| | MCF 0806 | 12~90Ω ±5Ω(12Ω), ±20%(Other) | |
| | MCF 1210 | 40~90Ω ±20%(2H900), ±25%(Other) | |
| | MCF 2010 | 90Ω ±25% | |
| | CK1608 | | |
| | CK2125 | | |
| | CKS2125 | | |
| | CKP1608 | | |
| | CKP2012 | | |
| | CKP2016 | | |
| | CKP2520 | | |
| | NM2012 | | |
| | NM2520 | | |
| | LK1005 | | |
| | LK1608 | | |
| | LK2125 | | |
| | HK0402/HKQ0402 | | |
| | HK0603 | | |
| | HK1005 | | |
| HK1608 | | | |
| HK2125 | | | |
| HKQ0603W/HKQ0603C/HKQ0603S/ HKQ0603U | | | |
| AQ105 | | | |
| Test Methods and Remarks | BK0402Series, BKP0402Series Measuring frequency : 100±1MHz Measuring equipment : E4991A(or its equivalent) Measuring jig : 16197A(or its equivalent) | | |
| | BK0603Series, BKP0603Series Measuring frequency : 100±1MHz Measuring equipment : 4291A(or its equivalent) Measuring jig : 16193A(or its equivalent) | | |
| | BK1005Series, BKP1005Series ,BKH1005Series Measuring frequency : 100±1MHz Measuring equipment : 4291A(or its equivalent) Measuring jig : 16192A(or its equivalent), 16193A(or its equivalent) | | |
| | BK1608・2125Series, BKP1608・2125Series Measuring frequency : 100±1MHz Measuring equipment : 4291A(or its equivalent), 4195A(or its equivalent) Measuring jig : 16092A(or its equivalent) or 16192A(or its equivalent)/HW | | |
| | BK2010・3216Series, MCFSeries Measuring frequency : 100±1MHz Measuring equipment : 4291A(or its equivalent), 4195A(or its equivalent) Measuring jig : 16192A(or its equivalent) | | |
| | | | |
| | | | |
| | | | |
| | | | |
| | | | |

▶ This catalog contains the typical specification only due to the limitation of space. When you consider the purchase of our products, please check our specification.
For details of each product (characteristics graph, reliability information, precautions for use, and so on), see our Web site (<http://www.ty-top.com/>).

5. Inductance

| | | |
|--------------------------|---|--|
| Specified Value | BK0402 | |
| | BK0603 | |
| | BK1005 | |
| | BKH0603 | |
| | BKH1005 | |
| | BK1608 | |
| | BK2125 | |
| | ARRAY | BK2010 BK3216 |
| | BKP0402 | |
| | BKP0603 | |
| | BKP1005 | |
| | BKP1608 | |
| | BKP2125 | |
| | MCF 0605 | |
| | MCF 0806 | |
| | MCF 1210 | |
| | MCF 2010 | |
| | CK1608 | 4.7~10.0 μH: ±20% |
| | CK2125 | 0.1~10.0 μH: ±20% |
| | CKS2125 | 1.0~10.0 μH: ±20% |
| | CKP1608 | 0.33~2.2 μH: ±20% |
| | CKP2012 | 0.47~4.7 μH: ±20% |
| | CKP2016 | 0.47~4.7 μH: ±20% |
| | CKP2520 | 0.47~4.7 μH: ±20% |
| | NM2012 | 0.82~1.0 μH: ±20% |
| | NM2520 | 1.0~2.2 μH: ±20% |
| | LK1005 | 0.12~2.2 μH: ±10 or 20% |
| | LK1608 | 0.047~33.0 μH: ±20% 0.10~12.0 μH: ±10% |
| LK2125 | 0.047~33.0 μH: ±20% 0.10~12.0 μH: ±10% | |
| HK0402 | 1.0~5.6nH: ±0.3nH 6.8~12nH: ±5% | |
| HK0603 | 1.0~6.2nH: ±0.3nH 6.8~100nH: ±5% | |
| HK1005 | 1.0~6.2nH: ±0.3nH 6.8~270nH: ±5% | |
| HK1608 | 1.0~5.6nH: ±0.3nH 6.8~470nH: ±5% | |
| HK2125 | 1.5~5.6nH: ±0.3nH 6.8~470nH: ±5% | |
| HKQ0402 | 0.5~3.9nH: ±0.1 or 0.2 or 0.3nH 4.3~5.6nH: ±0.3nH or 3% or 5% 6.2~47nH: ±3 or 5% | |
| HKQ0603W | 0.6~3.9nH: ±0.1 or 0.2 or 0.3nH 4.3~6.2nH: ±0.2 or 0.3nH or 3 or 5% 6.8~27nH: ±3 or 5% 33~100nH: ±5% | |
| HKQ0603C | 0.6~3.9nH: ±0.1 or 0.2 or 0.3nH 4.3~6.2nH: ±0.2 or 0.3nH 6.8~22nH: ±3 or 5% | |
| HKQ0603S | 0.6~6.2nH: ±0.2 or 0.3nH 6.8~22nH: ±3 or 5% | |
| HKQ0603U | 0.6~4.2nH: ±0.1 or 0.2 or 0.3nH 4.3~6.5nH: ±0.2 or 0.3nH 6.8~22nH: ±3 or 5% | |
| AQ105 | 1.0~6.2nH: ±0.3nH 6.8~15nH: ±5% | |
| Test Methods and Remarks | CK、LK、CKP、NM Series | |
| | Measuring frequency | : 2~4MHz (CK1608) |
| | Measuring frequency | : 2~25MHz (CK2125) |
| | Measuring frequency | : 2~10MHz (CKS2125) |
| | Measuring frequency | : 10~25MHz (LK1005) |
| | Measuring frequency | : 1~50MHz (LK1608) |
| | Measuring frequency | : 0.4~50MHz (LK2125) |
| | Measuring frequency | : 1MHz (CKP1608·CKP2012·CKP2016·CKP2520·NM2012·NM2520) |
| | Measuring equipment /jig | ·4194A+16085B+16092A (or its equivalent) ·4195A+41951+16092A (or its equivalent) ·4294A+16192A (or its equivalent) ·4291A+16193A (or its equivalent)/LK1005 ·4285A+42841A+42842C+42851-61100 (CKP1608·CKP2012·CKP2016·CKP2520·NM2012·NM2520) |
| | Measuring current | ·1mA rms (0.047~4.7 μH) ·0.1mA rms (5.6~33 μH) |
| | HK、HKQ、AQ Series | |
| | Measuring frequency | : 100MHz (HK0402·HK0603·HK1005·AQ105) |
| | Measuring frequency | : 50/100MHz (HK1608·HK2125) |
| | Measuring frequency | : 500MHz (HKQ0603C·HKQ0603S·HKQ0603U) |
| | Measuring frequency | : 300/500MHz (HKQ0603W) |
| | Measuring frequency | : 100/500MHz (HKQ0402) |
| | Measuring equipment /jig | ·4291A+16197A (or its equivalent)/HK0603·AQ105 ·4291A+16193A (or its equivalent)/HK1005 ·E4991A+16197A (or its equivalent)/HKQ0603S·HKQ0603U·HKQ0603W·HKQ0603C ·4291A+16092A + in-house made jig (or its equivalent)/HK1608·HK2125 ·E4991A+16196D (or its equivalent)/HK0402·HKQ0402 |

▶ This catalog contains the typical specification only due to the limitation of space. When you consider the purchase of our products, please check our specification.
For details of each product (characteristics graph, reliability information, precautions for use, and so on), see our Web site (<http://www.ty-top.com/>).

| | | | |
|--------------------------|--------------------------|---|--------|
| Specified Value | BK0402 | — | |
| | BK0603 | | |
| | BK1005 | | |
| | BKH0603 | | |
| | BKH1005 | | |
| | BK1608 | | |
| | BK2125 | | |
| | ARRAY | | BK2010 |
| | | | BK3216 |
| | BKP0402 | | |
| | BKP0603 | | |
| | BKP1005 | | |
| | BKP1608 | | |
| | BKP2125 | | |
| | MCF 0605 | | |
| | MCF 0806 | | |
| | MCF 1210 | | |
| | MCF 2010 | | |
| | CK1608 | | — |
| | CK2125 | | |
| | CKS2125 | | |
| | CKP1608 | | |
| | CKP2012 | | |
| | CKP2016 | | |
| | CKP2520 | | |
| | NM2012 | | |
| | NM2520 | | |
| | LK1005 | | |
| LK1608 | 10~35 min. | | |
| LK2125 | 15~50 min. | | |
| HK0402 | 3 min. | | |
| HK0603 | 4~5 min. | | |
| HK1005 | 8 min. | | |
| HK1608 | 8~12 min. | | |
| HK2125 | 10~18 min. | | |
| HKQ0402 | 3~8 min. | | |
| HKQ0603W | 6~15 min. | | |
| HKQ0603C | 14~15 min. | | |
| HKQ0603S | 10~13 min. | | |
| HKQ0603U | 14 min. | | |
| AQ105 | 8 min. | | |
| Test Methods and Remarks | LKSeries | | |
| | Measuring frequency | : 10~25MHz (LK1005) | |
| | Measuring frequency | : 1~50MHz (LK1608) | |
| | Measuring frequency | : 0.4~50MHz (LK2125) | |
| | Measuring equipment /jig | •4194A + 16085B + 16092A (or its equivalent) •4195A + 41951 + 16092A (or its equivalent) •4294A + 16192A (or its equivalent) •4291A + 16193A (or its equivalent) /LK1005 | |
| | Measuring current | •1mA rms (0.047~4.7 μ H) •0.1mA rms (5.6~33 μ H) | |
| | HK、HKQ、AQ Series | | |
| | Measuring frequency | : 100MHz (HK0402・HK0603・HK1005・AQ105) | |
| | Measuring frequency | : 50/100MHz (HK1608・HK2125) | |
| | Measuring frequency | : 500MHz (HKQ0603C・HKQ0603S・HKQ0603U) | |
| | Measuring frequency | : 300/500MHz (HKQ0603W) | |
| | Measuring frequency | : 100/500MHz (HKQ0402) | |
| | Measuring equipment /jig | •4291A + 16197A (or its equivalent) /HK0603・AQ105 •4291A + 16193A (or its equivalent) /HK1005 •E4991A + 16197A (or its equivalent) /HKQ0603S・HKQ0603U・HKQ0603W・HKQ0603C •4291A + 16092A + in-house made jig (or its equivalent) /HK1608, HK2125 •E4991A + 16196D (or its equivalent) HK0402・HKQ0402 | |

| 7. DC Resistance | | | |
|--------------------------|--|---------------------|------------------|
| Specified Value | BK0402 | 0.07~0.75 Ω max. | |
| | BK0603 | 0.065~1.50 Ω max. | |
| | BK1005 | 0.03~0.90 Ω max. | |
| | BKH0603 | 1.50~3.20 Ω max. | |
| | BKH1005 | 0.85~2.00 Ω max. | |
| | BK1608 | 0.05~1.10 Ω max. | |
| | BK2125 | 0.05~0.75 Ω max. | |
| | ARRAY | BK2010 | 0.10~0.90 Ω max. |
| | | BK3216 | 0.15~0.80 Ω max. |
| | BKP0402 | 0.07 Ω max. | |
| | BKP0603 | 0.030~0.180 Ω max. | |
| | BKP1005 | 0.0273~0.220 Ω max. | |
| | BKP1608 | 0.025~0.18 Ω max. | |
| | BKP2125 | 0.020~0.075 Ω max. | |
| | MCF 0605 | 2.5~6.5 Ω max | |
| | MCF 0806 | 2.5~5.0 Ω max. | |
| | MCF 1210 | 2.5~4.5 Ω max. | |
| | MCF 2010 | 4.5 Ω max. | |
| | CK1608 | 0.45~0.85 Ω (±30%) | |
| | CK2125 | 0.16~0.65 Ω max. | |
| | CKS2125 | 0.12~0.52 Ω max. | |
| | CKP1608 | 0.15~0.35 Ω max. | |
| | CKP2012 | 0.08~0.28 Ω max. | |
| | CKP2016 | 0.075~0.20 Ω max | |
| | CKP2520 | 0.05~0.16 Ω max. | |
| | NM2012 | 0.10~0.15 Ω max. | |
| | NM2520 | 0.11~0.22 Ω max. | |
| | LK1005 | 0.41~1.16 Ω max. | |
| | LK1608 | 0.2~2.2 Ω max. | |
| | LK2125 | 0.1~1.1 Ω max. | |
| | HK0402 | 0.18~0.99 Ω max. | |
| | HK0603 | 0.11~3.74 Ω max. | |
| | HK1005 | 0.08~4.8 Ω max. | |
| | HK1608 | 0.05~2.6 Ω max. | |
| | HK2125 | 0.10~1.5 Ω max. | |
| | HKQ0402 | 0.08~5.0 Ω max. | |
| | HKQ0603W | 0.07~4.1 Ω max. | |
| | HKQ0603C | 0.07~1.6 Ω max. | |
| | HKQ0603S | 0.06~1.29 Ω max. | |
| | HKQ0603U | 0.06~1.29 Ω max. | |
| AQ105 | 0.07~0.45 Ω max. | | |
| Test Methods and Remarks | Measuring equipment: VOAC-7412, VOAC-7512, VOAC-7521 (made by Iwasaki Tsushinki) | | |

8. Self Resonance Frequency (SRF)

| | | | |
|--------------------------|--|---|--------------------|
| Specified Value | BK0402 | — | |
| | BK0603 | | |
| | BK1005 | | |
| | BKH0603 | | |
| | BKH1005 | | |
| | BK1608 | | |
| | BK2125 | | |
| | ARRAY | | BK2010 |
| | | | BK3216 |
| | BKP0402 | | |
| | BKP0603 | | |
| | BKP1005 | | |
| | BKP1608 | | |
| | BKP2125 | | |
| | MCF 0605 | | |
| | MCF 0806 | | |
| | MCF 1210 | | |
| | MCF 2010 | | |
| | CK1608 | | 17~25MHz min. |
| | CK2125 | | 24~235MHz min. |
| | CKS2125 | | 24~75MHz min. |
| | CKP1608 | | — |
| | CKP2012 | | |
| | CKP2016 | | |
| | CKP2520 | | |
| | NM2012 | | |
| | NM2520 | | |
| | LK1005 | | |
| | LK1608 | | 9~260MHz min. |
| | LK2125 | | 13~320MHz min. |
| | HK0402 | | 2900~10000MHz min. |
| | HK0603 | | 900~10000MHz min. |
| | HK1005 | | 400~10000MHz min. |
| HK1608 | 300~10000MHz min. | | |
| HK2125 | 200~4000MHz min. | | |
| HKQ0402 | 1200~10000MHz min. | | |
| HKQ0603W | 800~10000MHz min. | | |
| HKQ0603C | 2500~10000MHz min. | | |
| HKQ0603S | 1900~10000MHz min. | | |
| HKQ0603U | 1900~10000MHz min. | | |
| AQ105 | 2300~10000MHz min. | | |
| Test Methods and Remarks | LK, CK Series : Measuring equipment : 4195A (or its equivalent) Measuring jig : 41951 + 16092A (or its equivalent) HK, HKQ, AQ Series : Measuring equipment : 8719C (or its equivalent) * 8753D (or its equivalent) / HK2125 | | |

9. Temperature Characteristic

| | | | | | | | |
|--------------------------|---|---|---|--------|---|---|--------------------------------------|
| Specified Value | BK0402 | - | | | | | |
| | BK0603 | | | | | | |
| | BK1005 | | | | | | |
| | BKH0603 | | - | | | | |
| | BKH1005 | | | | | | |
| | BK1608 | | | | | | |
| | BK2125 | | | | | | |
| | ARRAY | | | BK2010 | | | |
| | | | | BK3216 | | | |
| | BKP0402 | | | - | | | |
| | BKP0603 | | | | | | |
| | BKP1005 | | | | | | |
| | BKP1608 | | | | | | |
| | BKP2125 | | | | | | |
| | MCF 0605 | | | | | | |
| | MCF 0806 | | | | | | |
| | MCF 1210 | | | | | | |
| | MCF 2010 | | | | | | |
| | CK1608 | | | | - | | |
| | CK2125 | | | | | | |
| | CKS2125 | | | | | | |
| | CKP1608 | | | | | | |
| | CKP2012 | | | | | | |
| | CKP2016 | | | | | | |
| | CKP2520 | | | | | | |
| | NM2012 | | | | | | |
| | NM2520 | | | | | | |
| | LK1005 | | | | | - | |
| | LK1608 | | | | | | |
| | LK2125 | | | | | | |
| | HK0402 | | | | | | Inductance change: Within $\pm 10\%$ |
| | HK0603 | | | | | | |
| | HK1005 | | | | | | |
| HK1608 | | | | | | | |
| HK2125 | | | | | | | |
| HKQ0402 | | | | | | | |
| HKQ0603W | | | | | | | |
| HKQ0603C | | | | | | | |
| HKQ0603S | | | | | | | |
| HKQ0603U | | | | | | | |
| AQ105 | | | | | | | |
| Test Methods and Remarks | HK, HKQ, AQ Series: Temperature range : $-30\sim +85^{\circ}\text{C}$ Reference temperature : $+20^{\circ}\text{C}$ | | | | | | |

10. Resistance to Flexure of Substrate

| | | | |
|-----------------|----------|-----------------------|--------|
| Specified Value | BK0402 | No mechanical damage. | |
| | BK0603 | | |
| | BK1005 | | |
| | BKH0603 | | |
| | BKH1005 | | |
| | BK1608 | | |
| | BK2125 | | |
| | ARRAY | | BK2010 |
| | | | BK3216 |
| | BKP0402 | | |
| | BKP0603 | | |
| | BKP1005 | | |
| | BKP1608 | | |
| | BKP2125 | | |
| | MCF 0605 | | |
| | MCF 0806 | | |
| | MCF 1210 | | |
| | MCF 2010 | | |
| | CK1608 | | |
| | CK2125 | | |
| | CKS2125 | | |
| | CKP1608 | | |
| | CKP2012 | | |
| | CKP2016 | | |
| | CKP2520 | | |
| | NM2012 | | |
| | NM2520 | | |
| | LK1005 | | |
| | LK1608 | | |
| | LK2125 | | |
| | HK0402 | | |
| | HK0603 | | |
| | HK1005 | | |
| | HK1608 | | |
| | HK2125 | | |
| | HKQ0402 | | |
| | HKQ0603W | | |
| | HKQ0603C | | |
| | HKQ0603S | | |
| | HKQ0603U | | |
| | AQ105 | | |

| | |
|--------------------------|---|
| Test Methods and Remarks | <p>Warp : 2mm (BK Series without 0402size, BKP, BKH1005, CK, CKS, CKP, NM, LK, HK, HKQ0603S, HKQ0603U, AQ Series, MCF1210)</p> <p>: 1mm (BK0402, BKP0402, BKH0603, HK0402, HKQ0402, HKQ0603W, HKQ0603C Series, MCF Series without 1210 size.)</p> <p>Testing board : glass epoxy-resin substrate</p> <p>Thickness : 0.8mm</p> |
| | <p>(Unit: mm)</p> |

▶ This catalog contains the typical specification only due to the limitation of space. When you consider the purchase of our products, please check our specification. For details of each product (characteristics graph, reliability information, precautions for use, and so on), see our Web site (<http://www.ty-top.com/>).

11. Solderability

| | | | |
|--------------------------|--|--|--|
| Specified Value | BK0402 | At least 75% of terminal electrode is covered by new solder. | |
| | BK0603 | | |
| | BK1005 | | |
| | BKH0603 | | |
| | BKH1005 | | |
| | BK1608 | | |
| | BK2125 | | |
| | ARRAY | | BK2010 |
| | | | BK3216 |
| | BKP0402 | | |
| | BKP0603 | | |
| | BKP1005 | | |
| | BKP1608 | | |
| | BKP2125 | | |
| | MCF 0605 | | |
| | MCF 0806 | | |
| | MCF 1210 | | |
| | MCF 2010 | | |
| | CK1608 | | At least 75% of terminal electrode is covered by new solder. |
| | CK2125 | | |
| | CKS2125 | | |
| | CKP1608 | | |
| | CKP2012 | | |
| | CKP2016 | | |
| | CKP2520 | | |
| | NM2012 | | |
| | NM2520 | | |
| | LK1005 | | |
| LK1608 | | | |
| LK2125 | | | |
| HK0402 | | | |
| HK0603 | | | |
| HK1005 | | | |
| HK1608 | | | |
| HK2125 | | | |
| HKQ0402 | | | |
| HKQ0603W | | | |
| HKQ0603C | | | |
| HKQ0603S | | | |
| HKQ0603U | | | |
| AQ105 | | | |
| Test Methods and Remarks | Solder temperature : 230±5°C (JIS Z 3282 H60A or H63A) | | |
| | Solder temperature : 245±3°C (Sn/3.0Ag/0.5Cu) | | |
| | Duration : 4±1 sec. | | |

► This catalog contains the typical specification only due to the limitation of space. When you consider the purchase of our products, please check our specification. For details of each product (characteristics graph, reliability information, precautions for use, and so on), see our Web site (<http://www.ty-top.com/>).

12. Resistance to Soldering

| | | | |
|--------------------------|---|--|---|
| Specified Value | BK0402 | Appearance : No significant abnormality Impedance change : Within $\pm 30\%$ | |
| | BK0603 | | |
| | BK1005 | | |
| | BKH0603 | | |
| | BKH1005 | | |
| | BK1608 | | |
| | BK2125 | | |
| | ARRAY | | BK2010 BK3216 |
| | BKP0402 | | |
| | BKP0603 | | |
| | BKP1005 | | |
| | BKP1608 | | |
| | BKP2125 | | |
| | MCF 0605 | | Appearance : No significant abnormality Impedance change : Within $\pm 20\%$ |
| | MCF 0806 | | |
| | MCF 1210 | | |
| | MCF 2010 | | |
| | CK1608 | | No mechanical damage. Remaining terminal electrode : 70% min |
| | CK2125 | | |
| | CKS2125 | | Inductance change R10~4R7 : Within $\pm 10\%$ 6R8~100 : Within $\pm 15\%$ CKS2125 : Within $\pm 20\%$ CKP1608、CKP2012、CKP2016、CKP2520、NM2012、NM2520 : Within $\pm 30\%$ |
| CKP1608 | | | |
| CKP2012 | | | |
| CKP2016 | | | |
| CKP2520 | | | |
| NM2012 | | | |
| NM2520 | | | |
| LK1005 | No mechanical damage. Remaining terminal electrode : 70% min. Inductance change : Within $\pm 15\%$ | | |
| LK1608 | No mechanical damage. Remaining terminal electrode : 70% min. | | |
| LK2125 | Inductance change 47N~4R7 : Within $\pm 10\%$ 5R6~330 : Within $\pm 15\%$ | | |
| HK0402 | No mechanical damage. Remaining terminal electrode : 70% min. Inductance change : Within $\pm 5\%$ | | |
| HK0603 | | | |
| HK1005 | | | |
| HK1608 | | | |
| HK2125 | | | |
| HKQ0402 | | | |
| HKQ0603W | | | |
| HKQ0603C | | | |
| HKQ0603S | | | |
| HKQ0603U | | | |
| AQ105 | | | |
| Test Methods and Remarks | Solder temperature | : $260 \pm 5^\circ\text{C}$ | |
| | Duration | : 10 ± 0.5 sec. | |
| | Preheating temperature | : 150 to 180°C | |
| | Preheating time | : 3 min. | |
| | Flux | : Immersion into methanol solution with colophony for 3 to 5 sec. | |
| | Recovery | : 2 to 3 hrs of recovery under the standard condition after the test. (See Note 1) | |

13. Thermal Shock

| | | | |
|---|---|---|---|
| Specified Value | BK0402 | Appearance : No significant abnormality Impedance change : Within $\pm 30\%$ | |
| | BK0603 | | |
| | BK1005 | | |
| | BKH0603 | | |
| | BKH1005 | | |
| | BK1608 | | |
| | BK2125 | | |
| | ARRAY | | BK2010 BK3216 |
| | BKP0402 | | |
| | BKP0603 | | |
| | BKP1005 | | |
| | BKP1608 | | |
| | BKP2125 | | |
| | MCF 0605 | | |
| | MCF 0806 | | |
| | MCF 1210 | | |
| | MCF 2010 | | |
| | CK1608 | | No mechanical damage. |
| | CK2125 | | Inductance change : Within $\pm 20\%$ Q change : Within $\pm 30\%$ |
| | CKS2125 | | Inductance change : Within $\pm 20\%$ (CKS2125) |
| | CKP1608 | | No mechanical damage. Inductance change : Within $\pm 30\%$ |
| | CKP2012 | | |
| | CKP2016 | | |
| | CKP2520 | | |
| | NM2012 | | |
| | NM2520 | | |
| | LK1005 | | No mechanical damage. Inductance change : Within $\pm 10\%$ Q change : Within $\pm 30\%$ |
| | LK1608 | | |
| LK2125 | | | |
| HK0402 | No mechanical damage. Inductance change : Within $\pm 10\%$ Q change : Within $\pm 20\%$ | | |
| HK0603 | | | |
| HK1005 | | | |
| HK1608 | | | |
| HK2125 | | | |
| HKQ0402 | | | |
| HKQ0603W | | | |
| HKQ0603C | | | |
| HKQ0603S | | | |
| HKQ0603U | | | |
| AQ105 | | | |
| Test Methods and Remarks | | Conditions for 1 cycle | |
| | Step | temperature (°C) | time (min.) |
| | 1 | Minimum operating temperature +0/-3 | 30±3 |
| | 2 | Room temperature | 2~3 |
| | 3 | Maximum operating temperature +3/-0 | 30±3 |
| 4 | Room temperature | 2~3 | |
| Number of cycles : 5 | | | |
| Recovery : 2 to 3 hrs of recovery under the standard condition after the test. (See Note 1) | | | |

(Note 1) When there are questions concerning measurement result; measurement shall be made after 48±2 hrs of recovery under the standard condition.

| 14. Damp Heat (Steady state) | | | |
|-------------------------------|---|---|------------------|
| Specified Value | BK0402 | Appearance: No significant abnormality Impedance change: Within $\pm 30\%$ | |
| | BK0603 | | |
| | BK1005 | | |
| | BKH0603 | | |
| | BKH1005 | | |
| | BK1608 | | |
| | BK2125 | | |
| | ARRAY | | BK2010 BK3216 |
| | BKP0402 | | |
| | BKP0603 | | |
| | BKP1005 | | |
| | BKP1608 | | |
| | BKP2125 | | |
| | MCF 0605 | | |
| | MCF 0806 | | |
| | MCF 1210 | | |
| | MCF 2010 | | |
| | CK1608 | No mechanical damage. | |
| | CK2125 | Inductance change: Within $\pm 20\%$ Q change: Within $\pm 30\%$ | |
| | CKS2125 | Inductance change: Within $\pm 20\%$ | |
| | CKP1608 | No mechanical damage. Inductance change: Within $\pm 30\%$ | |
| | CKP2012 | | |
| | CKP2016 | | |
| | CKP2520 | | |
| | NM2012 | | |
| | NM2520 | | |
| | LK1005 | No mechanical damage. | |
| | LK1608 | Inductance change: Within $\pm 10\%$ Q change: Within $\pm 30\%$ | |
| | LK2125 | No mechanical damage. Inductance change: Within $\pm 20\%$ Q change: Within $\pm 30\%$ | |
| | HK0402 | No mechanical damage. Inductance change: Within $\pm 10\%$ Q change: Within $\pm 20\%$ | |
| | HK0603 | | |
| | HK1005 | | |
| HK1608 | | | |
| HK2125 | | | |
| HKQ0402 | | | |
| HKQ0603W | | | |
| HKQ0603C | | | |
| HKQ0603S | | | |
| HKQ0603U | | | |
| AQ105 | | | |
| Test Methods and Remarks | BK, BKP, BKH Series, MCF Series: Temperature : $40 \pm 2^\circ\text{C}$ Humidity : 90 to 95%RH Duration : $500 \pm 24 / -0$ hrs Recovery : 2 to 3 hrs of recovery under the standard condition after the removal from test chamber. (See Note 1) LK, CK, CKS, CKP, NM, HK, HKQ, AQ Series: Temperature : $40 \pm 2^\circ\text{C}$ (LK, CK, CKS, CKP, NM Series) : $60 \pm 2^\circ\text{C}$ (HK, HKQ, AQ Series) Humidity : 90 to 95%RH Duration : 500 ± 12 hrs Recovery : 2 to 3 hrs of recovery under the standard condition after the removal from test chamber. (See Note 1) | | |

15. Loading under Damp Heat

| | | | |
|--------------------------|--|---|--|
| Specified Value | BK0402 | Appearance: No significant abnormality Impedance change: Within $\pm 30\%$ | |
| | BK0603 | | |
| | BK1005 | | |
| | BKH0603 | | |
| | BKH1005 | | |
| | BK1608 | | |
| | BK2125 | | |
| | ARRAY | | BK2010 |
| | | | BK3216 |
| | BKP0402 | | |
| | BKP0603 | | |
| | BKP1005 | | |
| | BKP1608 | | |
| | BKP2125 | | |
| | CK1608 | | No mechanical damage. |
| | CK2125 | | Inductance change: Within $\pm 20\%$ Q change: Within $\pm 30\%$ |
| | CKS2125 | No mechanical damage. Inductance change: Within $\pm 20\%$ | |
| | CKP1608 | No mechanical damage. Inductance change: Within $\pm 30\%$ | |
| | CKP2012 | | |
| | CKP2016 | | |
| | CKP2520 | | |
| | NM2012 | | |
| | NM2520 | | |
| | LK1005 | No mechanical damage. Inductance change: Within $\pm 10\%$ Q change: Within $\pm 30\%$ | |
| | LK1608 | No mechanical damage. Inductance change: $0.047 \sim 12.0 \mu\text{H}$: Within $\pm 10\%$ $15.0 \sim 33.0 \mu\text{H}$: Within $\pm 15\%$ Q change: Within $\pm 30\%$ | |
| | LK2125 | No mechanical damage. Inductance change: Within $\pm 20\%$ Q change: Within $\pm 30\%$ | |
| | HK0402 | No mechanical damage. Inductance change: Within $\pm 10\%$ Q change: Within $\pm 20\%$ | |
| | HK0603 | | |
| | HK1005 | | |
| | HK1608 | | |
| | HK2125 | | |
| | HKQ0402 | | |
| HKQ0603W | | | |
| HKQ0603C | | | |
| HKQ0603S | | | |
| HKQ0603U | | | |
| AQ105 | | | |
| Test Methods and Remarks | <p>BK, BKP, BKH Series: Temperature : $40 \pm 2^\circ\text{C}$ Humidity : 90 to 95%RH Applied current : Rated current Duration : $500 + 24 / - 0$ hrs Recovery : 2 to 3 hrs of recovery under the standard condition after the removal from test chamber. (See Note 1)</p> <p>LK, CK, CKS, CKP, NK, HK, HKQ, AQ Series: Temperature : $40 \pm 2^\circ\text{C}$ (LK, CK, CKS, CKP, NM Series) : $60 \pm 2^\circ\text{C}$ (HK, HKQ, AQ Series) Humidity : 90 to 95%RH Applied current : Rated current Duration : 500 ± 12 hrs Recovery : 2 to 3 hrs of recovery under the standard condition after the removal from test chamber. (See Note 1)</p> | | |

Note on standard condition: "standard condition" referred to herein is defined as follows:

5 to 35°C of temperature, 45 to 85% relative humidity, and 86 to 106kPa of air pressure.

When there are questions concerning measurement results:

In order to provide correlation data, the test shall be conducted under condition of $20 \pm 2^\circ\text{C}$ of temperature, 60 to 70% relative humidity, and 86 to 106kPa of air pressure.

Unless otherwise specified, all the tests are conducted under the "standard condition."

(Note 1) Measurement shall be made after 48 ± 2 hrs of recovery under the standard condition.

16. Loading at High Temperature

| | | | |
|-----------------|----------|---|---|
| Specified Value | BK0402 | Appearance : No significant abnormality Impedance change : Within $\pm 30\%$ | |
| | BK0603 | | |
| | BK1005 | | |
| | BKH0603 | | |
| | BKH1005 | | |
| | BK1608 | | |
| | BK2125 | | |
| | ARRAY | | BK2010 BK3216 |
| | BKP0402 | | |
| | BKP0603 | | |
| | BKP1005 | | |
| | BKP1608 | | |
| | BKP2125 | | |
| | MCF 0605 | | Appearance : No significant abnormality Impedance change : Within $\pm 20\%$ |
| | MCF 0806 | | |
| | MCF 1210 | | |
| | MCF 2010 | | |
| | CK1608 | No mechanical damage. | |
| | CK2125 | Inductance change : Within $\pm 20\%$ Q change : Within $\pm 30\%$ | |
| | CKS2125 | No mechanical damage. Inductance change : Within $\pm 20\%$ | |
| | CKP1608 | No mechanical damage. Inductance change : Within $\pm 30\%$ | |
| | CKP2012 | | |
| | CKP2016 | | |
| | CKP2520 | | |
| | NM2012 | | |
| | NM2520 | | |
| | LK1005 | No mechanical damage. Inductance change : Within $\pm 10\%$ Q change : Within $\pm 30\%$ | |
| | LK1608 | No mechanical damage. Inductance change : 0.047~12.0 μ H : Within $\pm 10\%$ 15.0~33.0 μ H : Within $\pm 15\%$ Q change : Within $\pm 30\%$ | |
| | LK2125 | No mechanical damage. Inductance change : Within $\pm 20\%$ Q change : Within $\pm 30\%$ | |
| | HK0402 | No mechanical damage. Inductance change : Within $\pm 10\%$ Q change : Within $\pm 20\%$ | |
| | HK0603 | | |
| | HK1005 | | |
| | HK1608 | | |
| | HK2125 | | |
| | HKQ0402 | | |
| | HKQ0603W | | |
| | HKQ0603C | | |
| | HKQ0603S | | |
| | HKQ0603U | | |
| | AQ105 | | |

| | |
|--------------------------|---|
| Test Methods and Remarks | <p>BK, BKH, BKP Series, MCF Series: Temperature : 125\pm3$^{\circ}$C (BK, BKH Series) : 85\pm3$^{\circ}$C (BKP, MCF Series) Applied current : Rated current Duration : 500 + 24 / - 0 hrs Recovery : 2 to 3 hrs of recovery under the standard condition after the removal from test chamber. (See Note 1)</p> <p>LK, CK, CKS, CKP, NM, HK, HKQ, AQ Series: Temperature : 85\pm2$^{\circ}$C (LK, CK, CKS, CKP, NM Series) : 85\pm2$^{\circ}$C (HK1608, 2125) : 85\pm2$^{\circ}$C (HK1005, AQ105 operating temperature range -55~+85$^{\circ}$C) : 125\pm2$^{\circ}$C (HK0402, HKQ0402, HK0603, HK1005, HKQ0603S, HKQ0603W, HKQ0603C, AQ105 operating temperature range -55~+125$^{\circ}$C) Applied current : Rated current Duration : 500\pm12 hrs Recovery : 2 to 3 hrs of recovery under the standard condition after the test. (See Note 1)</p> |
|--------------------------|---|

Note on standard condition: "standard condition" referred to herein is defined as follows:
5 to 35 $^{\circ}$ C of temperature, 45 to 85% relative humidity, and 86 to 106kPa of air pressure.

When there are questions concerning measurement results:

In order to provide correlation data, the test shall be conducted under condition of 20 \pm 2 $^{\circ}$ C of temperature, 60 to 70% relative humidity, and 86 to 106kPa of air pressure. Unless otherwise specified, all the tests are conducted under the "standard condition."

(Note 1) Measurement shall be made after 48 \pm 2 hrs of recovery under the standard condition.

▶ This catalog contains the typical specification only due to the limitation of space. When you consider the purchase of our products, please check our specification.
For details of each product (characteristics graph, reliability information, precautions for use, and so on), see our Web site (<http://www.ty-top.com/>).

Precautions on the use of Multilayer chip inductors

Multilayer chip inductors for high frequency, Multilayer chip bead inductors

Multilayer common mode choke coils (MC series F type)

■ PRECAUTIONS

1. Circuit Design

- Precautions**
- ◆ Verification of operating environment, electrical rating and performance
 1. A malfunction in medical equipment, spacecraft, nuclear reactors, etc. may cause serious harm to human life or have severe social ramifications.
As such, any inductors to be used in such equipment may require higher safety and/or reliability considerations and should be clearly differentiated from components used in general purpose applications.
 - ◆ Operating Current (Verification of Rated current)
 1. The operating current for inductors must always be lower than their rated values.
 2. Do not apply current in excess of the rated value because the inductance may be reduced due to the magnetic saturation effect.

2. PCB Design

- Precautions**
- ◆ Pattern configurations (Design of Land-patterns)
 1. When inductors are mounted on a PCB, the size of land patterns and the amount of solder used (size of fillet) can directly affect inductor performance.
Therefore, the following items must be carefully considered in the design of solder land patterns:
 - (1) The amount of solder applied can affect the ability of chips to withstand mechanical stresses which may lead to breaking or cracking. Therefore, when designing land-patterns it is necessary to consider the appropriate size and configuration of the solder pads which in turn determines the amount of solder necessary to form the fillets.
 - (2) When more than one part is jointly soldered onto the same land or pad, the pad must be designed so that each component's soldering point is separated by solder-resist.
 - (3) The larger size of land patterns and amount of solder, the smaller Q value after mounting on PCB. It makes higher the Q value to design land patterns smaller than terminal electrode of chips.
 - ◆ Pattern configurations (Inductor layout on panelized [breakaway] PC boards)
 1. After inductors have been mounted on the boards, chips can be subjected to mechanical stresses in subsequent manufacturing processes (PCB cutting, board inspection, mounting of additional parts, assembly into the chassis, wave soldering the reflow soldered boards etc.) For this reason, planning pattern configurations and the position of SMD inductors should be carefully performed to minimize stress.

- Technical considerations**
- ◆ Pattern configurations (Design of Land-patterns)
 1. The following diagrams and tables show some examples of recommended patterns to prevent excessive solder amounts (larger fillets which extend above the component end terminations). Examples of improper pattern designs are also shown.
 - (1) Recommended land dimensions for a typical chip inductor land patterns for PCBs

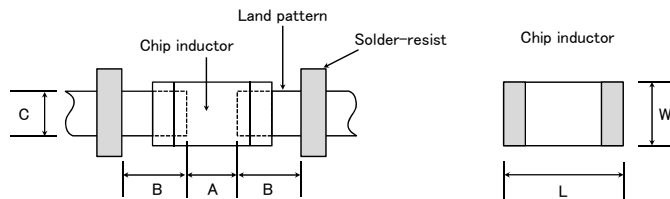

Recommended land dimensions for wave-soldering (Unit: mm)

| Type | 1608 | 2012 | 2125 | 2016 | 2520 | 3216 |
|------|---------|---------|---------|---------|---------|---------|
| Size | L | 1.6 | 2.0 | 2.0 | 2.5 | 3.2 |
| | W | 0.8 | 1.25 | 1.25 | 1.6 | 2.0 |
| A | 0.8~1.0 | 1.0~1.4 | 1.0~1.4 | 1.0~1.4 | 1.0~1.4 | 1.8~2.5 |
| B | 0.5~0.8 | 0.8~1.5 | 0.8~1.5 | 0.8~1.5 | 0.6~1.0 | 0.8~1.7 |
| C | 0.6~0.8 | 0.9~1.2 | 0.9~1.2 | 1.3~1.6 | 1.6~2.0 | 1.2~1.6 |

Recommended land dimensions for reflow-soldering (Unit: mm)

| Type | 0402 | 0603 | 1005 | 105 | 1608 | 2012 |
|------|-----------|-----------|-----------|-----------|---------|---------|
| Size | L | 0.4 | 0.6 | 1.0 | 1.6 | 2.0 |
| | W | 0.2 | 0.3 | 0.5 | 0.6 | 0.8 |
| A | 0.15~0.25 | 0.20~0.30 | 0.45~0.55 | 0.50~0.55 | 0.8~1.0 | 0.8~1.2 |
| B | 0.10~0.20 | 0.20~0.30 | 0.40~0.50 | 0.30~0.40 | 0.6~0.8 | 0.8~1.2 |
| C | 0.15~0.30 | 0.25~0.40 | 0.45~0.55 | 0.60~0.70 | 0.6~0.8 | 0.9~1.6 |

| Type | 2125 | 2016 | 2520 | 3216 |
|------|---------|---------|---------|---------|
| Size | L | 2.0 | 2.0 | 3.2 |
| | W | 1.25 | 1.6 | 2.0 |
| A | 0.8~1.2 | 0.8~1.2 | 1.0~1.4 | 1.8~2.5 |
| B | 0.8~1.2 | 0.8~1.2 | 0.6~1.0 | 0.6~1.5 |
| C | 0.9~1.6 | 1.2~2.0 | 1.8~2.2 | 1.2~2.0 |

▶ This catalog contains the typical specification only due to the limitation of space. When you consider the purchase of our products, please check our specification. For details of each product (characteristics graph, reliability information, precautions for use, and so on), see our Web site (<http://www.ty-top.com/>).

Excess solder can affect the ability of chips to withstand mechanical stresses. Therefore, please take proper precautions when designing land-patterns.

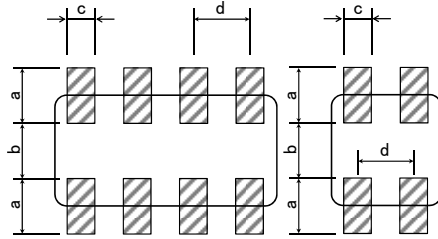

Recommended land dimension for Reflow-soldering

| Type | 3216 | 2010 | 1210 | 0806 | 0605 | |
|------|---------|---------|-----------|-----------|-----------|------|
| Size | L | 3.2 | 2.0 | 1.25 | 0.85 | 0.65 |
| | W | 1.6 | 1.0 | 1.0 | 0.65 | 0.50 |
| a | 0.7~0.9 | 0.5~0.6 | 0.45~0.55 | 0.25~0.35 | 0.27~0.33 | |
| b | 0.8~1.0 | 0.5~0.6 | 0.7~0.8 | 0.25~0.35 | 0.17~0.23 | |
| c | 0.4~0.5 | 0.2~0.3 | 0.25~0.35 | 0.25~0.35 | 0.20~0.26 | |
| d | 0.8 | 0.5 | 0.55 | 0.5 | 0.4 | |

(Unit: mm)

(2) Examples of good and bad solder application

| Item | Not recommended | Recommended |
|---|--|---------------|
| Mixed mounting of SMD and leaded components | Lead wire of component | Solder-resist |
| Component placement close to the chassis | Chassis Solder (for grounding) Electrode pattern | Solder-resist |
| Hand-soldering of leaded components near mounted components | Lead wire of component Soldering iron | Solder-resist |
| Horizontal component placement | | Solder-resist |

◆ Pattern configurations (Inductor layout on panelized [breakaway] PC boards)

1-1. The following are examples of good and bad inductor layout; SMD inductors should be located to minimize any possible mechanical stresses from board warp or deflection.

| Item | Not recommended | Recommended |
|-------------------------|-----------------|---|
| Deflection of the board | | Position the component at a right angle to the direction of the mechanical stresses that are anticipated. |

1-2. To layout the inductors for the breakaway PC board, it should be noted that the amount of mechanical stresses given will vary depending on inductor layout.

An example below should be counted for better design.

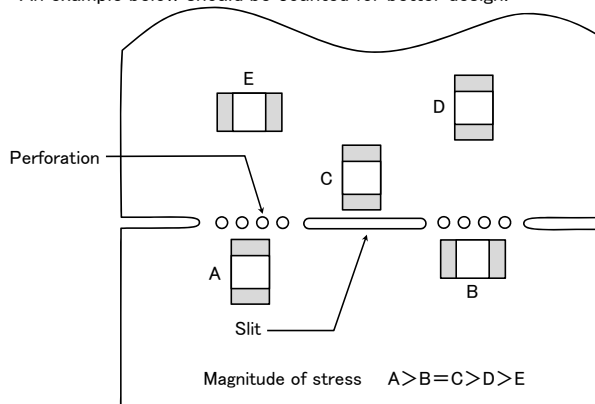

1-3. When breaking PC boards along their perforations, the amount of mechanical stress on the inductors can vary according to the method used. The following methods are listed in order from least stressful to most stressful: push-back, slit, V-grooving, and perforation. Thus, any ideal SMD inductor layout must also consider the PCB splitting procedure.

3. Considerations for automatic placement

Precautions

- ◆ Adjustment of mounting machine
 1. Excessive impact load should not be imposed on the inductors when mounting onto the PC boards.
 2. The maintenance and inspection of the mounter should be conducted periodically.
- ◆ Selection of Adhesives
 1. Mounting inductors with adhesives in preliminary assembly, before the soldering stage, may lead to degraded inductor characteristics unless the following factors are appropriately checked; the size of land patterns, type of adhesive, amount applied, hardening temperature and hardening period. Therefore, it is imperative to consult the manufacturer of the adhesives on proper usage and amounts of adhesive to use.

Technical considerations

- ◆ Adjustment of mounting machine
 1. If the lower limit of the pick-up nozzle is low, too much force may be imposed on the inductors, causing damage. To avoid this, the following points should be considered before lowering the pick-up nozzle:
 - (1) The lower limit of the pick-up nozzle should be adjusted to the surface level of the PC board after correcting for deflection of the board.
 - (2) The pick-up pressure should be adjusted between 1 and 3N static loads.
 - (3) To reduce the amount of deflection of the board caused by impact of the pick-up nozzle, supporting pins or back-up pins should be used under the PC board. The following diagrams show some typical examples of good pick-up nozzle placement:

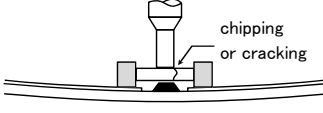
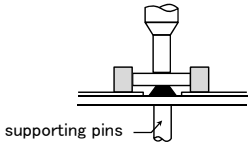
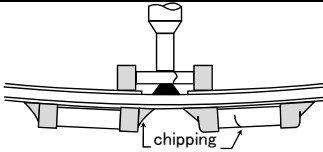
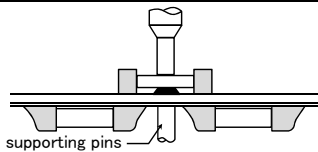
| Item | Improper method | Proper method |
|-----------------------|---|---|
| Single-sided mounting |  |  |
| Double-sided mounting |  |  |

2. As the alignment pin wears out, adjustment of the nozzle height can cause chipping or cracking of the inductors because of mechanical impact on the inductors. To avoid this, the monitoring of the width between the alignment pin in the stopped position, and maintenance, inspection and replacement of the pin should be conducted periodically.
- ◆ Selection of Adhesives
 1. Some adhesives may cause reduced insulation resistance. The difference between the shrinkage percentage of the adhesive and that of the inductors may result in stresses on the inductors and lead to cracking. Moreover, too little or too much adhesive applied to the board may adversely affect component placement, so the following precautions should be noted in the application of adhesives.
 - (1) Required adhesive characteristics
 - a. The adhesive should be strong enough to hold parts on the board during the mounting & solder process.
 - b. The adhesive should have sufficient strength at high temperatures.
 - c. The adhesive should have good coating and thickness consistency.
 - d. The adhesive should be used during its prescribed shelf life.
 - e. The adhesive should harden rapidly.
 - f. The adhesive must not be contaminated.
 - g. The adhesive should have excellent insulation characteristics.
 - h. The adhesive should not be toxic and have no emission of toxic gasses.
 - (2) When using adhesives to mount inductors on a PCB, inappropriate amounts of adhesive on the board may adversely affect component placement. Too little adhesive may cause the inductors to fall off the board during the solder process. Too much adhesive may cause defective soldering due excessive flow of adhesive on to the land or solder pad.

[Recommended conditions]

| Figure | 0805 case sizes as examples |
|--------|-----------------------------|
| a | 0.3mm min |
| b | 100~120 μm |
| c | Area with no adhesive |

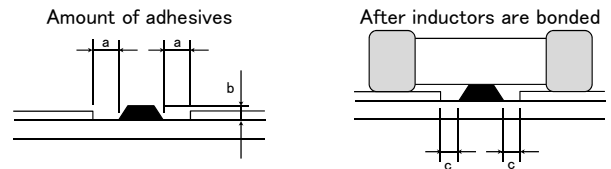

4. Soldering

Precautions

- ◆ Selection of Flux
 1. Since flux may have a significant effect on the performance of inductors, it is necessary to verify the following conditions prior to use;
 - (1) Flux used should be with less than or equal to 0.1 wt% (Chlorine conversion method) of halogenated content. Flux having a strong acidity content should not be applied.
 - (2) When soldering inductors on the board, the amount of flux applied should be controlled at the optimum level.
 - (3) When using water-soluble flux, special care should be taken to properly clean the boards.
- ◆ Soldering
 1. Temperature, time, amount of solder, etc. are specified in accordance with the following recommended conditions, and please contact us about peak temperature when you use lead-free paste.

◆ Selection of Flux

- 1-1. When too much halogenated substance (Chlorine, etc.) content is used to activate the flux, or highly acidic flux is used, an excessive amount of residue after soldering may lead to corrosion of the terminal electrodes or degradation of insulation resistance on the surface of the Inductor.
- 1-2. Flux is used to increase solderability in flow soldering, but if too much is applied, a large amount of flux gas may be emitted and may detrimentally affect solderability. To minimize the amount of flux applied, it is recommended to use a flux-bubbling system.
- 1-3. Since the residue of water-soluble flux is easily dissolved by water content in the air, the residue on the surface of Inductor in high humidity conditions may cause a degradation of insulation resistance and therefore affect the reliability of the components. The cleaning methods and the capability of the machines used should also be considered carefully when selecting water-soluble flux.

◆ Soldering

1-1. Preheating when soldering

Heating: Chip inductor components should be preheated to within 100 to 130°C of the soldering. Cooling: The temperature difference between the components and cleaning process should not be greater than 100°C.

Chip inductors are susceptible to thermal shock when exposed to rapid or concentrated heating or rapid cooling. Therefore, the soldering process must be conducted with a great care so as to prevent malfunction of the components due to excessive thermal shock.

Recommended conditions for soldering

[Reflow soldering]

Temperature profile

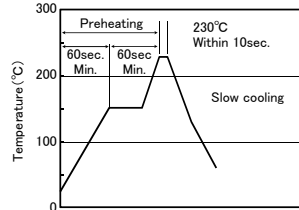

Pb free soldering

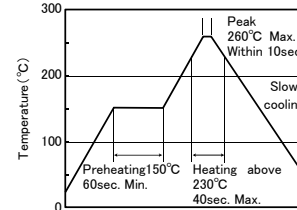

※Ceramic chip components should be preheated to within 100 to 130°C of the soldering.

※Assured to be reflow soldering for 2 times.

Caution

- 1. The ideal condition is to have solder mass (fillet) controlled to 1/2 to 1/3 of the thickness of the inductor, as shown below:

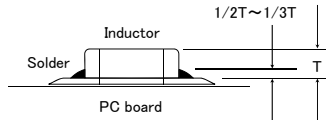

- 2. Because excessive dwell times can detrimentally affect solderability, soldering duration should be kept as close to recommended times as possible.

[Wave soldering]

Temperature profile

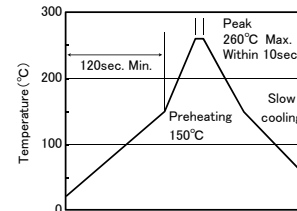
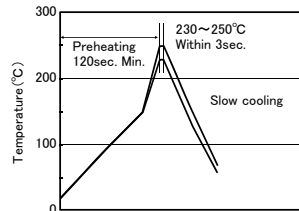

※Ceramic chip components should be preheated to within 100 to 130°C of the soldering.

※Assured to be wave soldering for 1 time.
 ※Except for reflow soldering type.

Caution

- 1. Make sure the inductors are preheated sufficiently.
- 2. The temperature difference between the inductor and melted solder should not be greater than 100 to 130°C.
- 3. Cooling after soldering should be as gradual as possible.
- 4. Wave soldering must not be applied to the inductors designated as for reflow soldering only.

[Hand soldering]

Temperature profile

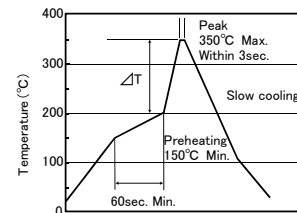
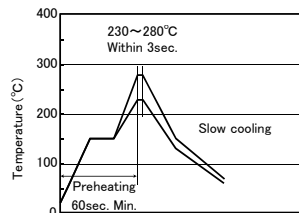

※ $\Delta T \leq 190^\circ\text{C}$ (3216 Type max), $\Delta T \leq 130^\circ\text{C}$ (3225 Type min)

※It is recommended to use 20W soldering iron and the tip is 1 φ or less.

※The soldering iron should not directly touch the components.

※Assured to be soldering iron for 1 time.

Note: The above profiles are the maximum allowable soldering condition, therefore these profiles are not always recommended.

Technical considerations

| | |
|--|--|
| | <p>Caution</p> <ol style="list-style-type: none"> 1. Use a 20W soldering iron with a maximum tip diameter of 1.0 mm. 2. The soldering iron should not directly touch the inductor. |
|--|--|

5. Cleaning

| | | | | | | | |
|---------------------------|--|-------------------|-------------|----------------------|-------------|---------------------------|----------------|
| Precautions | <p>◆Cleaning conditions</p> <ol style="list-style-type: none"> 1. When cleaning the PC board after the Inductors are all mounted, select the appropriate cleaning solution according to the type of flux used and purpose of the cleaning (e.g. to remove soldering flux or other materials from the production process.) 2. Cleaning conditions should be determined after verifying, through a test run, that the cleaning process does not affect the inductor's characteristics. | | | | | | |
| Technical considerations | <p>◆Cleaning conditions</p> <ol style="list-style-type: none"> 1. The use of inappropriate solutions can cause foreign substances such as flux residue to adhere to the inductor, resulting in a degradation of the inductor's electrical properties (especially insulation resistance). 2. Inappropriate cleaning conditions (insufficient or excessive cleaning) may detrimentally affect the performance of the inductors. <ol style="list-style-type: none"> (1) Excessive cleaning <ol style="list-style-type: none"> a. In the case of ultrasonic cleaning, too much power output can cause excessive vibration of the PC board which may lead to the cracking of the inductor or the soldered portion, or decrease the terminal electrodes' strength. Thus the following conditions should be carefully checked; <table style="margin-left: 20px; border: none;"> <tr> <td style="padding-right: 20px;">Ultrasonic output</td> <td>Below 20W/l</td> </tr> <tr> <td>Ultrasonic frequency</td> <td>Below 40kHz</td> </tr> <tr> <td>Ultrasonic washing period</td> <td>5 min. or less</td> </tr> </table> | Ultrasonic output | Below 20W/l | Ultrasonic frequency | Below 40kHz | Ultrasonic washing period | 5 min. or less |
| Ultrasonic output | Below 20W/l | | | | | | |
| Ultrasonic frequency | Below 40kHz | | | | | | |
| Ultrasonic washing period | 5 min. or less | | | | | | |

6. Post cleaning processes

| | |
|-------------|--|
| Precautions | <p>◆Application of resin coatings, moldings, etc. to the PCB and components.</p> <ol style="list-style-type: none"> 1. With some type of resins a decomposition gas or chemical reaction vapor may remain inside the resin during the hardening period or while left under normal storage conditions resulting in the deterioration of the inductor's performance. 2. When a resin's hardening temperature is higher than the inductor's operating temperature, the stresses generated by the excess heat may lead to inductor damage or destruction. 3. Stress caused by a resin's temperature generated expansion and contraction may damage inductors. <p>The use of such resins, molding materials etc. is not recommended.</p> |
|-------------|--|

7. Handling

| | |
|-------------|---|
| Precautions | <p>◆Breakaway PC boards (splitting along perforations)</p> <ol style="list-style-type: none"> 1. When splitting the PC board after mounting inductors and other components, care is required so as not to give any stresses of deflection or twisting to the board. 2. Board separation should not be done manually, but by using the appropriate devices. <p>◆General handling precautions</p> <ol style="list-style-type: none"> 1. Always wear static control bands to protect against ESD. 2. Keep the inductors away from all magnets and magnetic objects. 3. Use non-magnetic tweezers when handling inductors. 4. Any devices used with the inductors (soldering irons, measuring instruments) should be properly grounded. 5. Keep bare hands and metal products (i.e., metal desk) away from chip electrodes or conductive areas that lead to chip electrodes. 6. Keep inductors away from items that generate magnetic fields such as speakers or coils. <p>◆Mechanical considerations</p> <ol style="list-style-type: none"> 1. Be careful not to subject the inductors to excessive mechanical shocks. <ol style="list-style-type: none"> (1) If inductors are dropped on the floor or a hard surface they should not be used. (2) When handling the mounted boards, be careful that the mounted components do not come in contact with or bump against other boards or components. |
|-------------|---|

8. Storage conditions

| | |
|--------------------------|--|
| Precautions | <p>◆Storage</p> <ol style="list-style-type: none"> 1. To maintain the solderability of terminal electrodes and to keep the packaging material in good condition, care must be taken to control temperature and humidity in the storage area. Humidity should especially be kept as low as possible. <p style="margin-left: 20px;">Recommended conditions</p> <p style="margin-left: 40px;">Ambient temperature Below 40°C</p> <p style="margin-left: 40px;">Humidity Below 70% RH</p> <p style="margin-left: 20px;">The ambient temperature must be kept below 30°C. Even under ideal storage conditions inductor electrode solderability decreases as time passes, so inductors should be used within 6 months from the time of delivery.</p> <p style="margin-left: 20px;">*The packaging material should be kept where no chlorine or sulfur exists in the air.</p> |
| Technical considerations | <p>◆Storage</p> <ol style="list-style-type: none"> 1. If the parts are stocked in a high temperature and humidity environment, problems such as reduced solderability caused by oxidation of terminal electrodes and deterioration of taping/packaging materials may take place. For this reason, components should be used within 6 months from the time of delivery. If exceeding the above period, please check solderability before using the inductors. |

▶ This catalog contains the typical specification only due to the limitation of space. When you consider the purchase of our products, please check our specification. For details of each product (characteristics graph, reliability information, precautions for use, and so on), see our Web site (<http://www.ty-top.com/>).