

# TT9 SMT Series

Attenuator Chip 500 Milliwatts

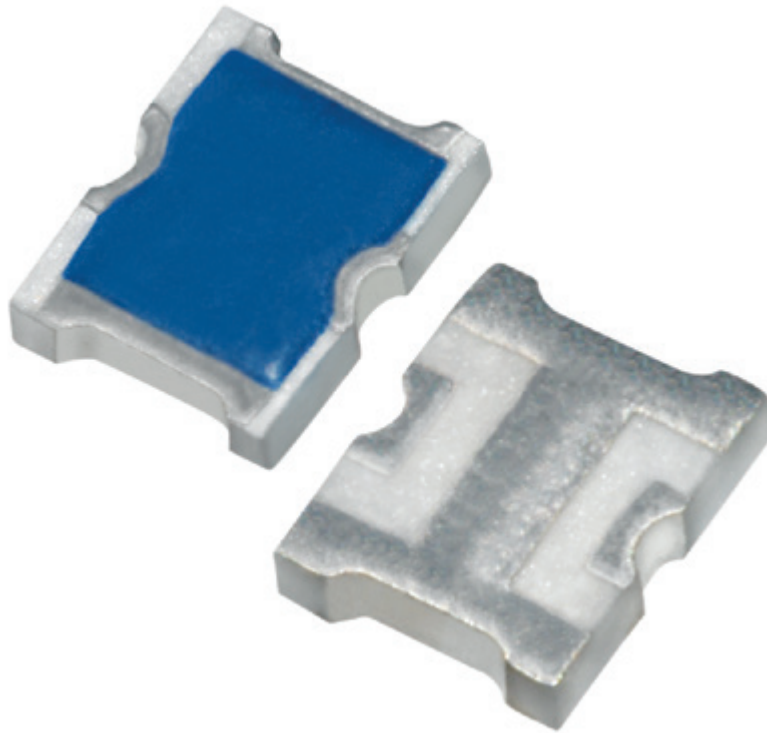

# TT9 SMT Series

Attenuator Chip 500 Milliwatts

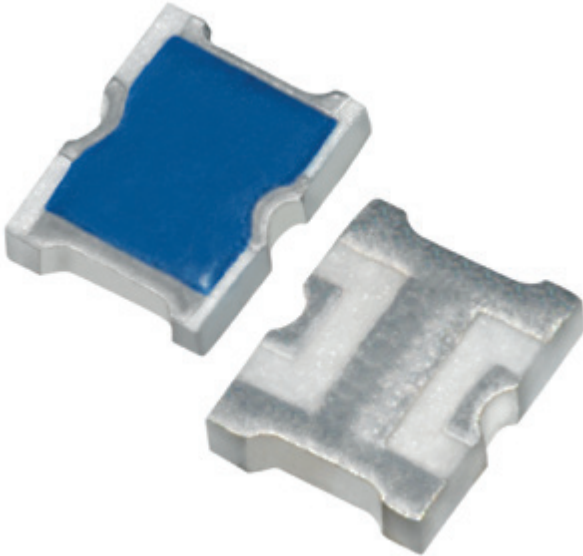

Smiths Interconnect offers the widest selection of products from DC through Q band. Backed by proven performance and significant heritage, Smiths Interconnect is the leader in high reliability components.

Smiths Interconnect introduces the TT9 series, a new wideband surface mount fixed attenuator optimized for performance from DC to 20 GHz. Utilizing our 40 plus years of experience in refining attenuation solutions, the TT9 offers the best performance to date for high frequency applications in an SMT package. These devices are noted for their excellent performance and small size, measuring only 0.070" x 0.060" (1.78mm X 1.62mm). The TT9 wideband fixed attenuator handles 500mW of input power and is available in dB values from 0 to 10 dB in 1 dB increments. In addition, Smiths Interconnect can develop custom variations specific to the frequency band of your application. The same footprint is also offered in a temperature variable version, the WTVA SMT series, for ultimate design flexibility. This product is available in a both RoHS compliant and Sn60Pb40 solder finish versions and supplied on tape and reel for high volume pick and place applications.

Full test qualification test report and RF test report are available for this series on our website. A product kits with an evaluation board is also available.

TT9 SMT Series,  
specifically designed for  
surface mount broadband  
applications which  
require more power.

## Features and Benefits

- Small Footprint
- High Power
- Surface Mount
- Low VSWR
- Easy Installation
- Wide Attenuation Offering

## Applications

- Mobile Networks
- Broadcast
- High Power Amplifiers
- Isolators/Circulators
- Military
- Instrumentation

# Technical Characteristics

Mounting Configuration Options	Surface Mount (SMT)
--------------------------------	---------------------

## Electrical

Nominal Impedance	50 ohms		
Frequency Range	DC -20 GHz		
Attenuation Values Available	1-10 in 1 dB Increments		
Attenuation Accuracy	ATTENUATION ACCURACY		
	Attenuation Value (dB)	DC-15 GHz	15-20 GHz
	0-4	± 0.5	± 0.5
	5-10	± 0.5	± 0.75
Input Power CW	500 Milliwatts Max up to 125°C (See derating curve)		
Peak Power	5 Watts based on 10 µS pulse width @ 1% Duty Cycle		
VSWR	1.40:1 Typical DC-20 GHz, 1.70:1 Max 10-20 GHz		

## Environmental

Operating Temperature	-55°C to +150°C
Storage Temperature	-65°C to +150°C
Moisture Sensitivity Level	MSL 1 - Unlimited

## Mechanical

Substrate Material	Alumina (Al <sub>2</sub> O <sub>3</sub> ) 96%
Resistive Film	Thick Film
Terminal Material	Thick Film
Protective Coating	Polymer
Finish Options	Blank Solder Plated (Sn60/Pb40)
	-F Silver Plated (RoHS Compliant)

## Marking

Unit Marking	None
--------------	------

## Quality Assurance

Sample visual and mechanical inspection - 1.0 AQL per mechanical drawing requirements. Periodic electrical inspection performed for commercial grade products. High reliability tested products are available per MIL-PRF-55342.
--

## Packaging

Standard Packaging	Tape and Reel or Waffle Pack
--------------------	------------------------------

# Power Derating Curve

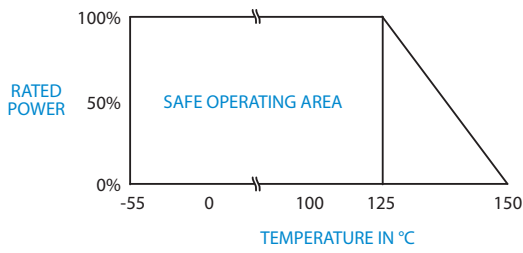

# Typical Data

## TT9 Series Attenuation

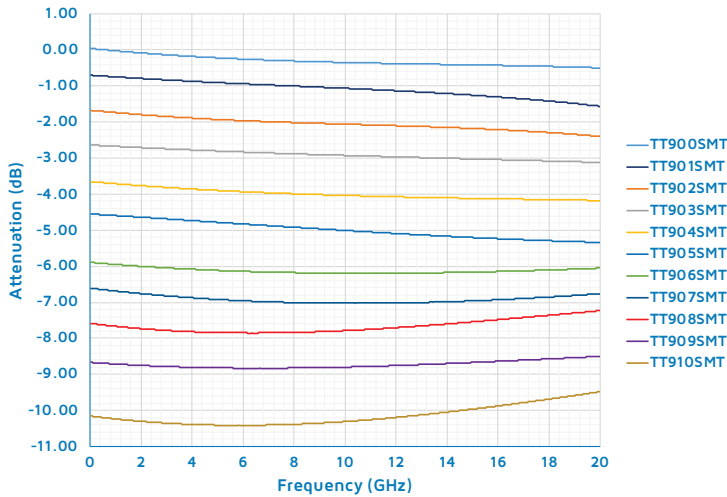

## TT9 Series VSWR

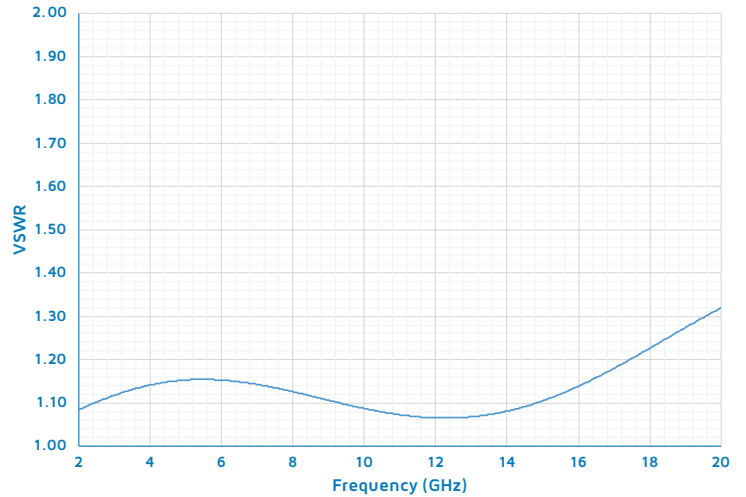

# Mechanical

## TT9 - Surface Mount

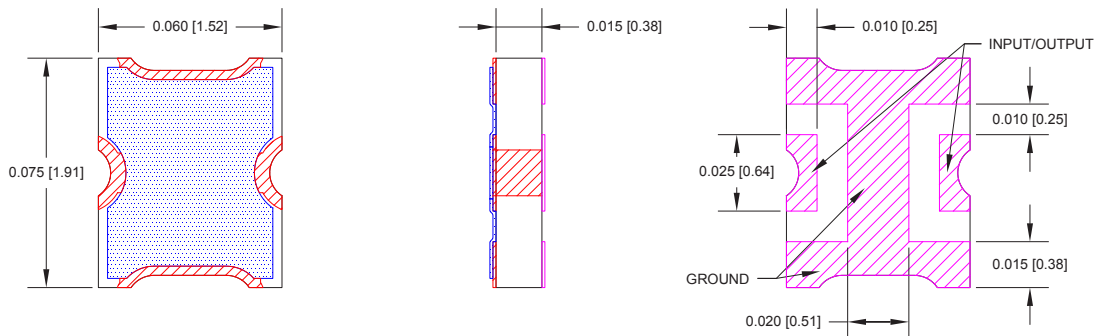

Unless otherwise specified, tolerance: X.XXX = ±0.005"

# Suggested Mounting Footprint

Part Number	Inches						MM					
	A	B	C	D	S	W	A	B	C	D	S	W
TT9XXSMT	0.025	0.015	0.016	0.049	0.018	0.070	0.64	0.38	0.41	1.24	0.46	1.78

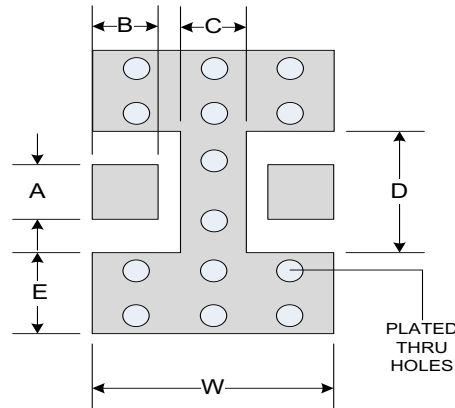

## How To Order

Specify Model Number: **TT9XX.0XXXX**

	1	2	3	4
<b>1 Series Name</b>	TT9 Series			
<b>2 Attenuation Value</b>	.0 00.0 dB through .0 10.0 dB			
<b>3 Options</b>	SMT Surface Mount			
<b>4 Terminal Finish</b>	Standard F RoHS			

# Global Support

## UK Headquarters

- London, UK  
+44 20 7004 1600  
info.uk@smithsinterconnect.com

## US Headquarters

- Stuart, FL  
+1 772 286 9300  
info.us@smithsinterconnect.com

## Americas

- Costa Mesa, CA  
+1 714 371 1100  
info.us@smithsinterconnect.com
- Milpitas, CA  
+1 408 957 9607 x-1125  
info.us@smithsinterconnect.com
- Stuart, FL  
+1 772 286 9300  
info.us@smithsinterconnect.com
- Hudson, MA  
+1 978 568 0451  
info.us@smithsinterconnect.com
- Northampton, MA  
+1 413 582 9620  
info.northampton@smithsinterconnectinc.com
- Tampa, FL  
+ 1 813 901 7200  
info.tampa@smithsinterconnectinc.com
- Kansas City, KS  
+1 913 342 5544  
info.us@smithsinterconnect.com
- Salisbury, MD  
+1 800 780 2169  
info.us@smithsinterconnect.com
- Thousand Oaks, CA  
+1 805 267 0100  
info.thousandoaks@smithsinterconnectinc.com

## Europe

- Deggendorf, Germany  
+49 991 250 120  
info.de@smithsinterconnect.com
- Genova, Italy  
+39 0 10 60361  
info.it@smithsinterconnect.com
- Dundee, UK  
+44 1382 427 200  
info.dundee@smithsinterconnect.com
- Rouen, France  
+33 2 32 96 91 76  
info.fr@smithsinterconnect.com
- Elstree, UK  
+44 20 8236 2400  
info.uk@smithsinterconnect.com

## Asia

- Shanghai, China  
+86 21 3318 4650  
info.asia@smithsinterconnect.com
- Suzhou, China  
+86 512 6273 1188  
info.asia@smithsinterconnect.com
- Singapore  
+65 6846 1655  
info.asia@smithsinterconnect.com

more > [smithsinterconnect.com](http://smithsinterconnect.com) | [in](#) [twitter](#) [G+](#) [YouTube](#)