

### Applications

- W-CDMA / LTE
- Macrocell Base Station Driver
- Microcell Base Station
- Small Cell Final Stage
- Active Antenna
- General Purpose Applications

### Product Features

- Operating Frequency Range: DC to 4 GHz
- Output Power ( $P_{SAT}$ ): 30 W
- Drain Efficiency: 64%
- Linear Gain: 17 dB
- Package Dimensions: 3 x 4 x 0.85 mm

### General Description

The TQP0104 is a wide band over-molded QFN discrete GaN power amplifier. The device is a single stage unmatched power amplifier transistor.

The TQP0104 can be used in Doherty architecture for the final stage of a base station power amplifier for small cell, microcell, and active antenna systems. The TQP0104 can also be used as a driver in a macrocell base station power amplifier.

The wide bandwidth of the TQP0104 makes it suitable for many different applications from DC to 4 GHz. TQP0104 can deliver  $P_{SAT}$  of 30 W at 28 to 32 V operation.

Lead-free and ROHS compliant.

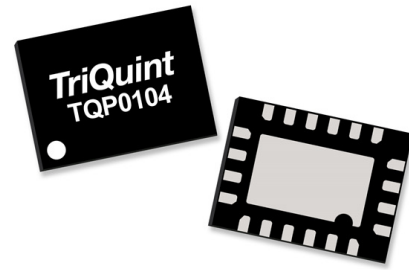

20 Pin 3x4mm QFN

### Functional Block Diagram

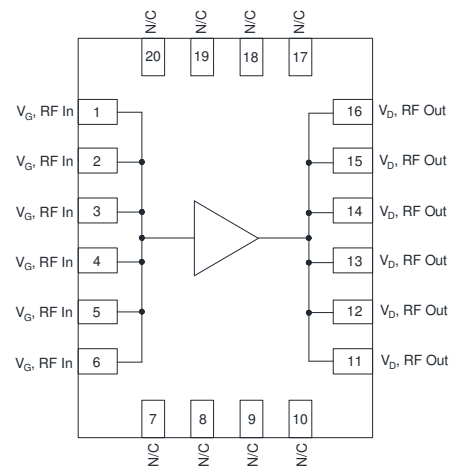

### Pin Configuration

Pin No.	Label
1-6	RF IN, $V_G$
7-10, 17-20	N/C
11-16	RF OUT, $V_D$
Backside Paddle	RF/DC GND

### Ordering Information

Part No.	ECCN	Description
TQP0104	EAR99	30 W, DC to 4 GHz, GaN PA
TQP0104-2.6-EVB	EAR99	2.5-2.7 GHz Eval Board
TQP0104-2.1-DOH	EAR99	2.1 GHz Doherty Eval Board

### Absolute Maximum Ratings

Parameter	Rating
Gate Voltage ( $V_G$ )	-6 V
Drain Voltage ( $V_D$ )	+40 V
Peak RF Input Power	35 dBm
VSWR Mismatch, P1dB Pulse (20% duty cycle, 100 $\mu$ s width), T = 25°C	10:1
Storage Temperature	-65 to +150°C

Operation of this device outside the parameter ranges given above may cause permanent damage.

### Recommended Operating Conditions

Parameter	Min	Typ	Max	Units
Operating Temperature	-40		+105	°C
Gate Voltage ( $V_G$ )		-2.9		V
Drain Voltage ( $V_D$ )		32		V
Quiescent Current ( $I_{CQ}$ )		60		mA
$T_{CH}$ for $>10^6$ hours MTTF			225	°C

Electrical performance is measured under conditions noted in the electrical specifications table. Specifications are not guaranteed over all recommended operating conditions.

### Electrical Specifications

Test conditions unless otherwise noted:  $V_G = -2.73$  V,  $V_D = 32$  V,  $I_{CQ} = 70$  mA, T = 25°C, 2.6 GHz single-ended applications circuit

Parameter	Conditions	Min	Typ	Max	Units
Frequency Range		DC		4000	MHz
Quiescent Current		60	70	80	mA
Linear Gain	$P_{OUT} = 33$ dBm, Pulsed (10% duty cycle, 100 $\mu$ s width)	15	17		dB
P3dB	Pulsed (10% duty cycle, 100 $\mu$ s width)	44.0	44.6		dBm
Drain Efficiency	P3dB	60	64		%
Input Return Loss			11		dB

**Thermal Information**

Parameter	Conditions	Value	Units
Thermal Resistance at Average Power ( $\theta_{JC}$ )	$T_{CASE} = 85^{\circ}C$ , $T_{CH} = 128.0^{\circ}C$ , CW: $P_{DISS} = 8.83$ W, $P_{OUT} = 1.90$ W	4.9	$^{\circ}C/W$
Thermal Resistance at Saturated Power ( $\theta_{JC}$ )	$T_{CASE} = 85^{\circ}C$ , $T_{CH} = 173.3^{\circ}C$ , CW: $P_{DISS} = 16.80$ W, $P_{OUT} = 30.55$ W	5.3	$^{\circ}C/W$

Notes:

1. Thermal resistance measured to package backside.

**Median Lifetime**

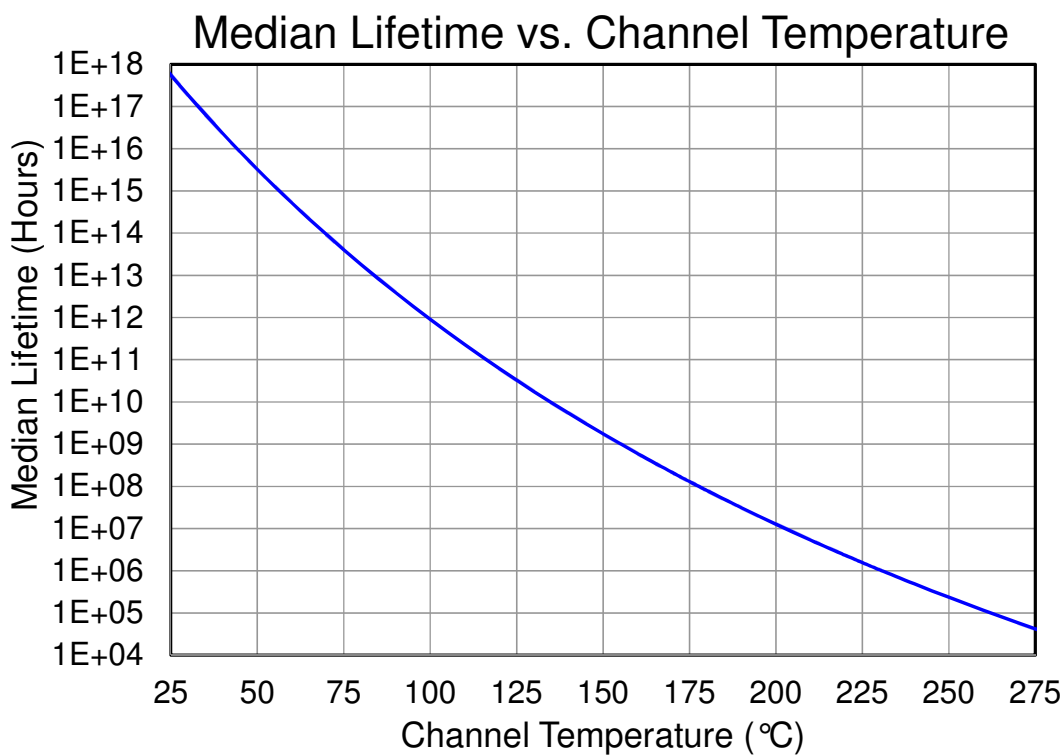

## TQP0104 Single-Ended Evaluation Board Layout (2500-2700 MHz)

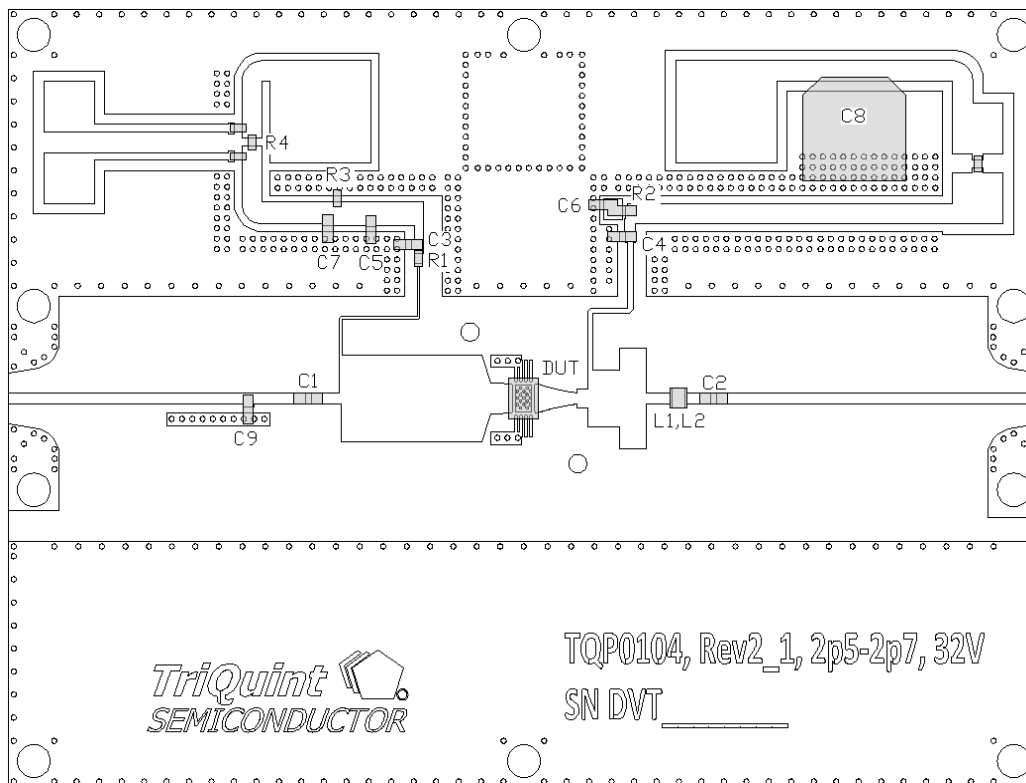

## Bill of Materials – TQP0104 Single-Ended Evaluation Board (2500-2700 MHz)

Reference Des.	Value	Description	Manuf.	Part Number
C1, C2, C3, C4	10.0 pF	Capacitor	ATC	600S
L1, L2	1.8 nH	Inductor	Coilcraft	0603HP
C9	1.5 pF	Capacitor	ATC	600S
R1	20 $\Omega$	Resistor	Venkel	0603-8 LCR
C5, C6	1000 pF	Capacitor	various	
R2	10 $\Omega$	Resistor	Venkel	0603-8 LCR
R3	1000 $\Omega$	Resistor	Venkel	0603-8 LCR
C7	1 $\mu$ F	Capacitor	various	
R4	0 $\Omega$	Jumper	Venkel	0603-8 LCR
C8	220 $\mu$ F	Capacitor, Electrolytic	various	

### Performance Plots – TQP0104 Single-Ended Eval. Board (2500-2700 MHz)

Test conditions unless otherwise noted:  $V_D = 32\text{ V}$ ,  $I_{CQ} = 70\text{ mA}$ ,  $T = 25^\circ\text{C}$ , 2.6 GHz single-ended application circuit

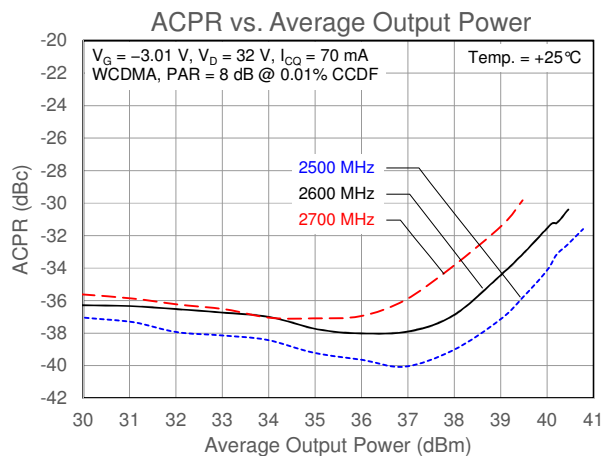
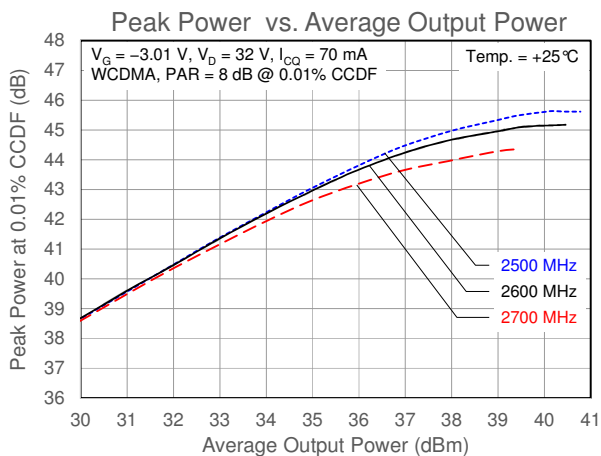
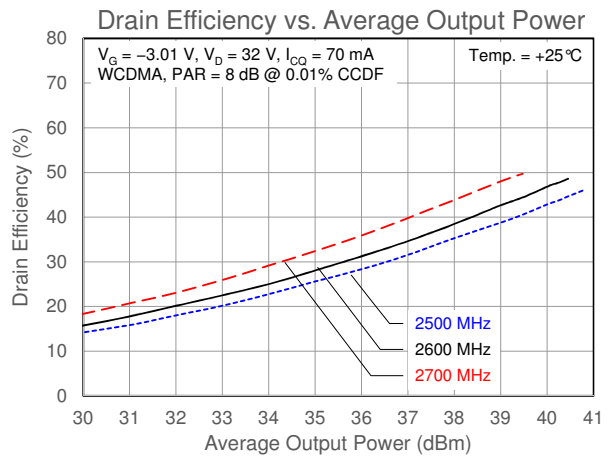
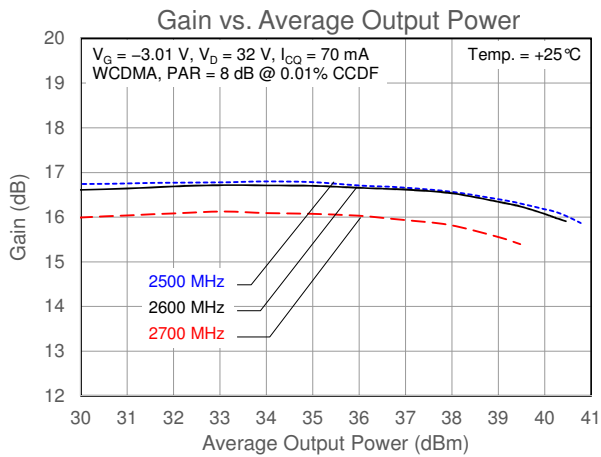
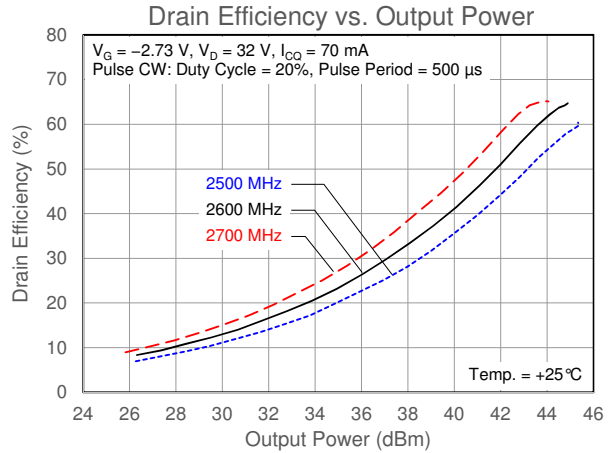
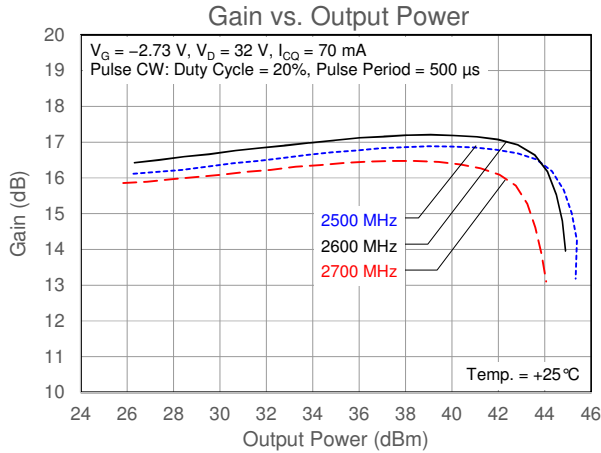

**Performance Plots – TQP0104 Single-Ended Eval. Board (2500-2700 MHz)**

Test conditions unless otherwise noted:  $V_D = 32\text{ V}$ ,  $I_{CQ} = 70\text{ mA}$ ,  $T = 25^\circ\text{C}$ , 2.6 GHz single-ended application circuit

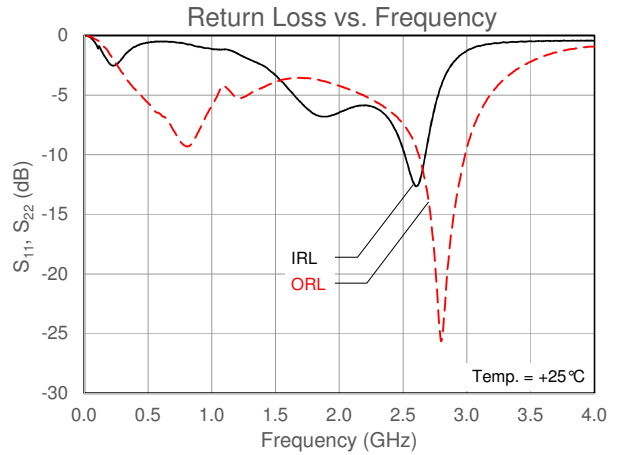
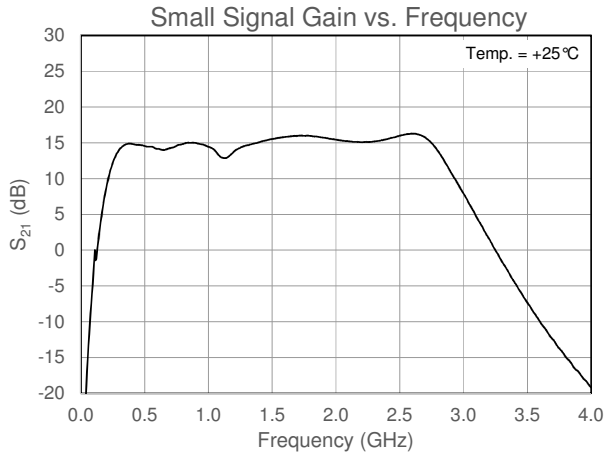

**Load Pull Plots**

Test conditions unless otherwise noted:  $V_D = 32\text{ V}$ ,  $I_{CQ} = 70\text{ mA}$ ,  $T = \text{ }^\circ\text{C}$ , Pulse CW (duty cycle = 20%, pulse period = 500  $\mu\text{s}$ )

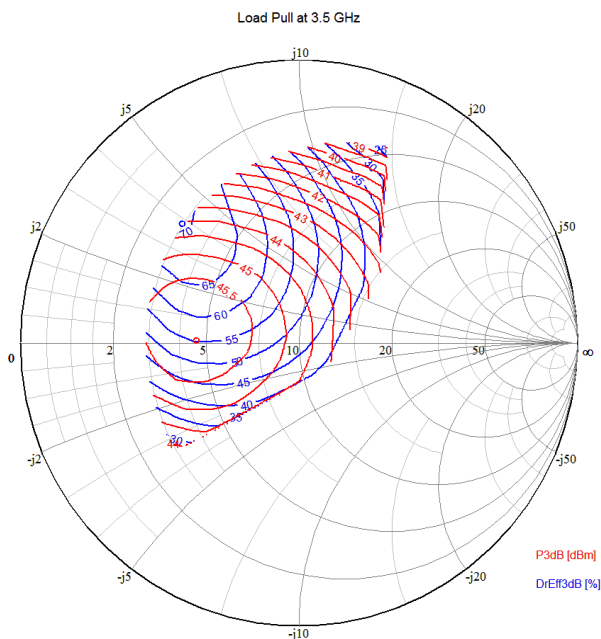
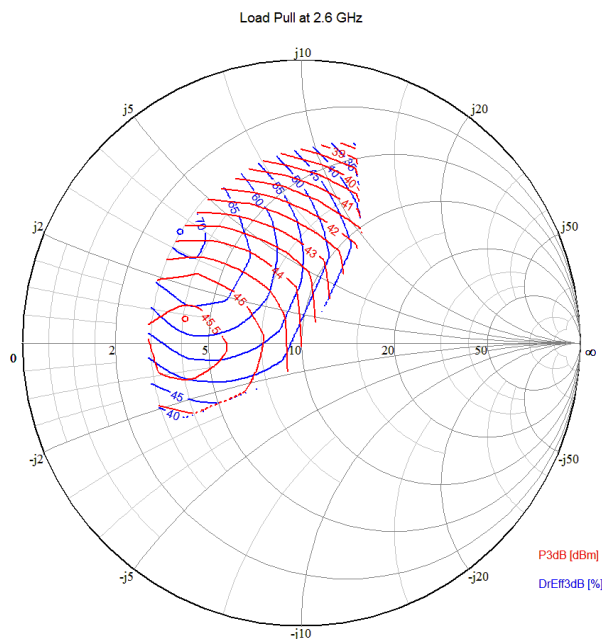
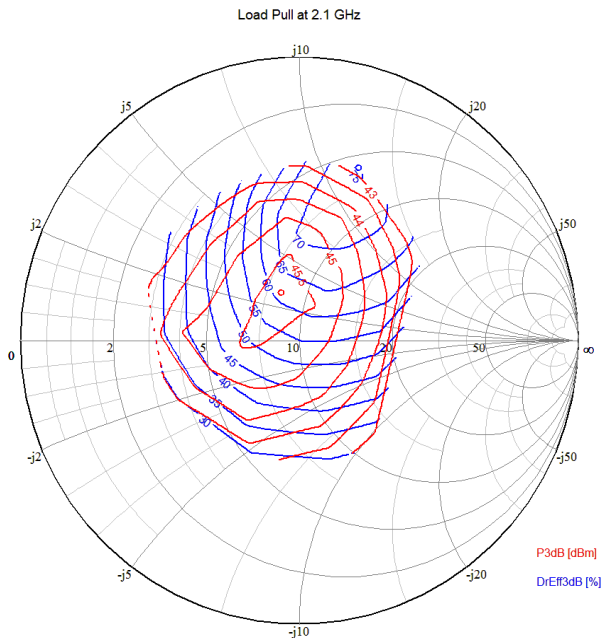
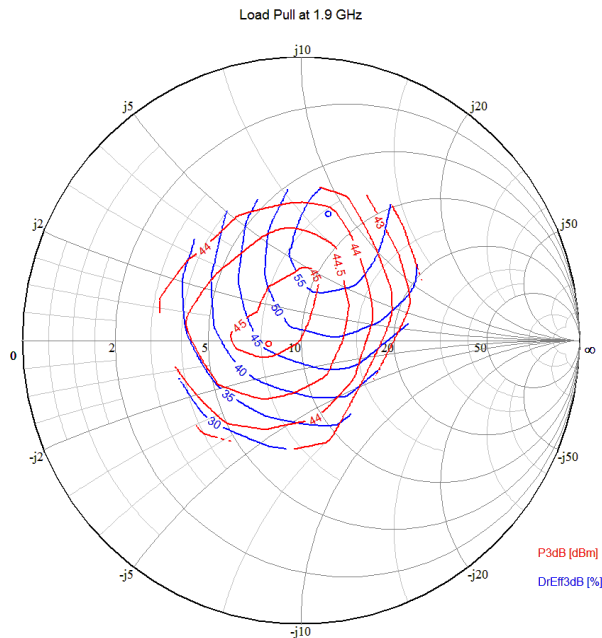

## TQP0104 Doherty Evaluation Board Layout (2110-2170 MHz)

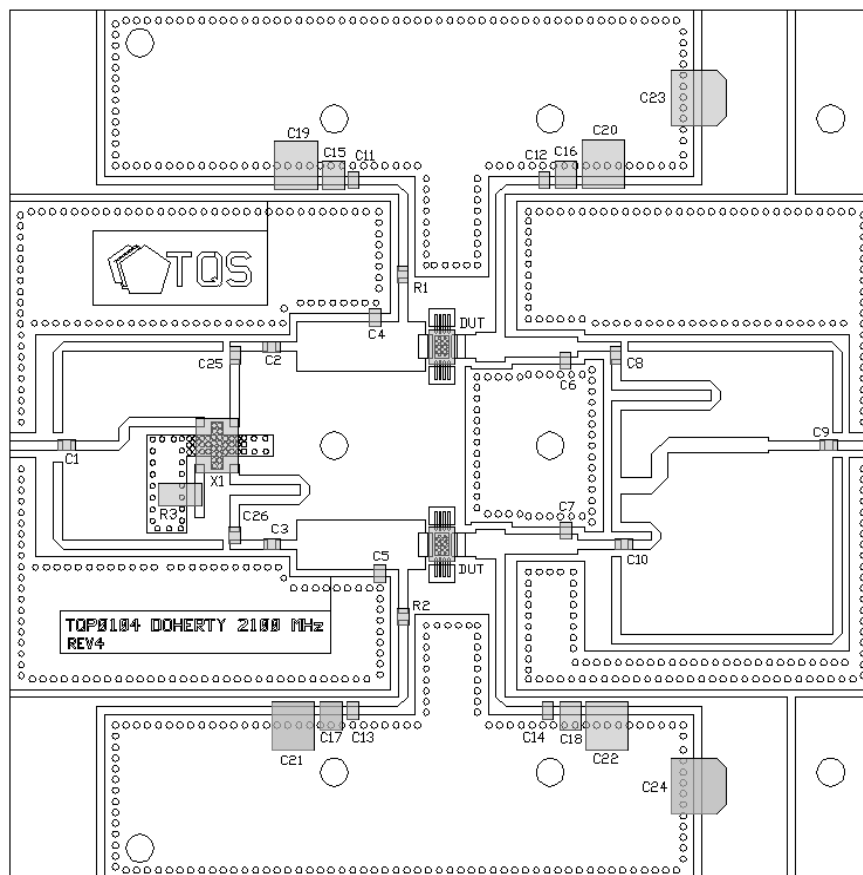

### Bill of Materials – TQP0104 Doherty Evaluation Board (2110-2170 MHz)

Reference Des.	Value	Description	Manuf.	Part Number
C1, C2, C3, C8, C9, C10, C11, C12, C13, C14, C25, C26	33 pF	Capacitor	ATC	600F
C4, C5	3.3 pF	Capacitor	ATC	600S
C6, C7	1.8 pF	Capacitor	ATC	600S
C15, C16, C17, C18	1 $\mu$ F	Capacitor		
C19, C20, C21, C22	10 $\mu$ F	Capacitor		
C23, C24	220 $\mu$ F	Capacitor, Electrolytic	United Chemi-Con	
R1, R2	10 $\Omega$	Resistor		
R3	50 $\Omega$	Resistor, 10 W	ATC	CS12010T0050GBK
X1		Hybrid Coupler, 2.0-2.3 GHz	Anaren	JP503S/JP503AS



### Performance Plots – TQP0104 Doherty Evaluation Board (2110-2170 MHz)

Test conditions unless otherwise noted:  $V_{G,CARRIER} = -2.81$  V,  $V_{G,PEAKING} = -4.7$  V,  $V_D = 32$  V,  $I_{CQ} = 100$  mA,  $T = 25^\circ\text{C}$ , 2.1 GHz Doherty application circuit

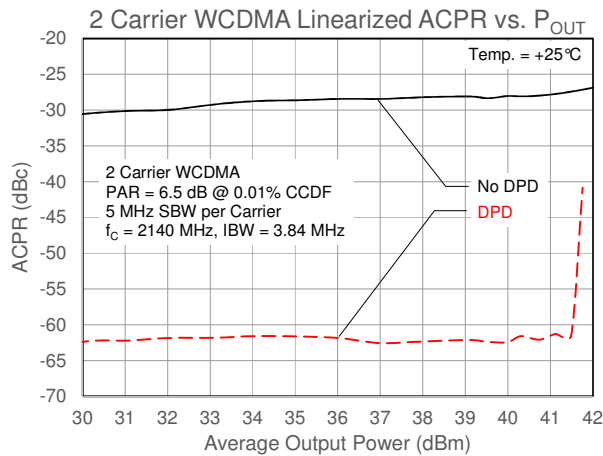
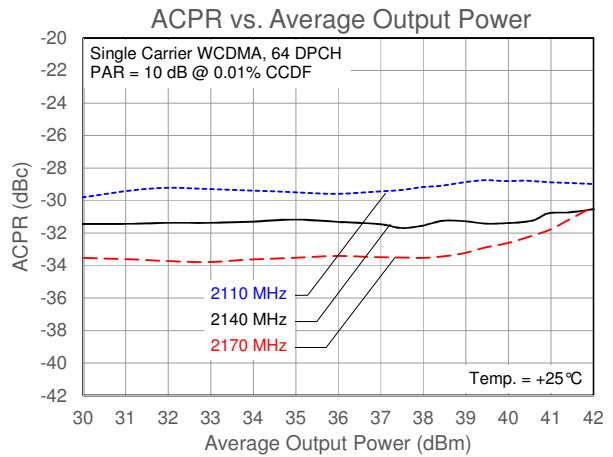
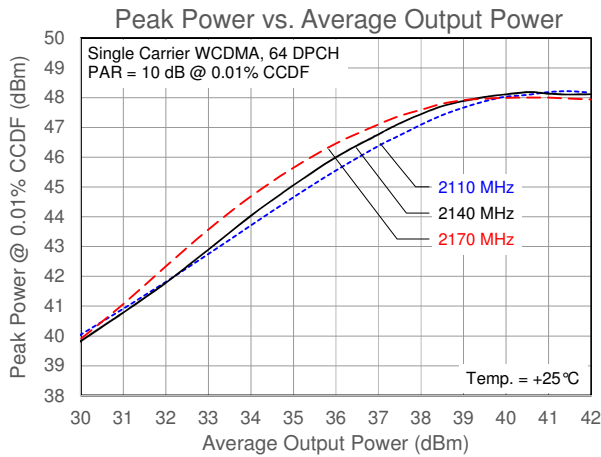
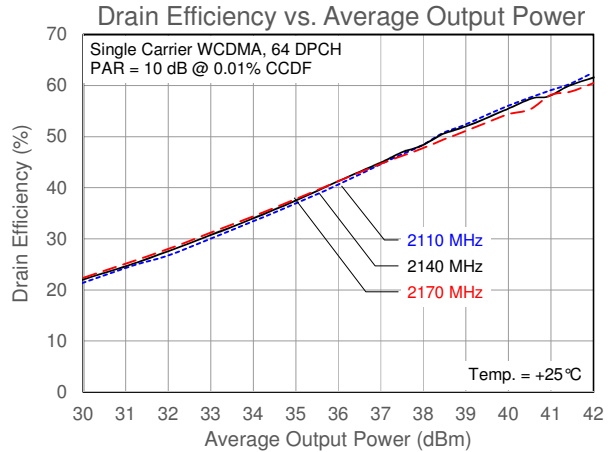
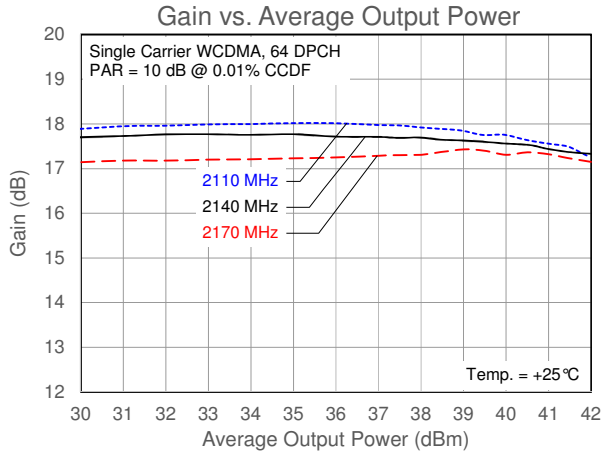

## Pin Configuration and Description

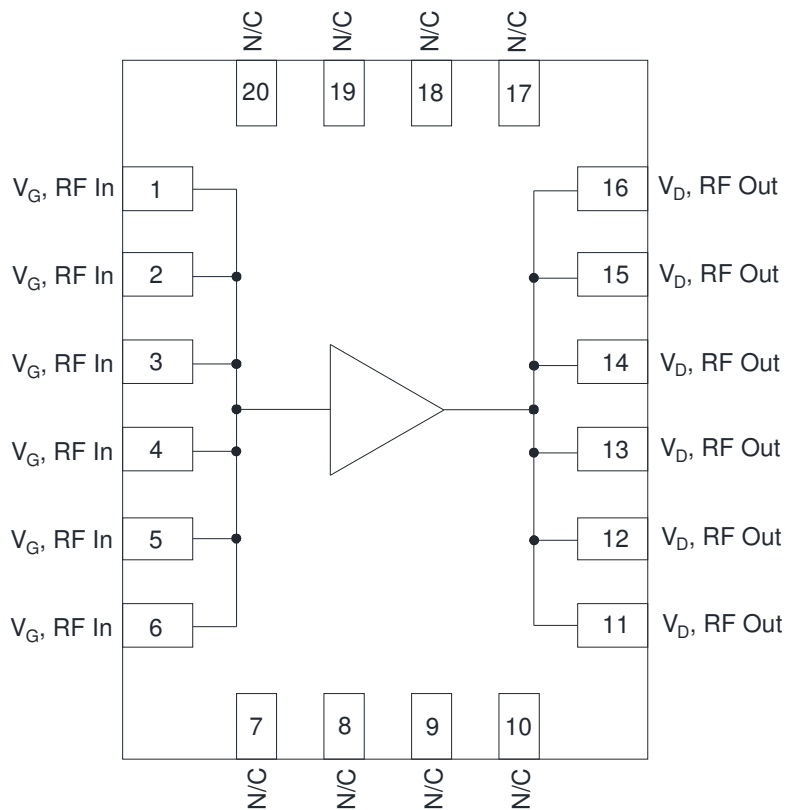

Pin No.	Label	Description
1, 2, 3, 4, 5, 6	RF IN, $V_G$	RF Input, Gate Bias
7, 8, 9, 10, 17, 18, 19, 20	N/C	No Connection
11, 12, 13, 14, 15, 16	RF OUT, $V_D$	RF Output, Drain Bias
Backside Paddle	RF/DC GND	RF/DC Ground

## Package Marking and Dimensions

Marking: Part ID – 0104  
 Year/Workweek – YYWW  
 "M" + Lot Number – MXXX

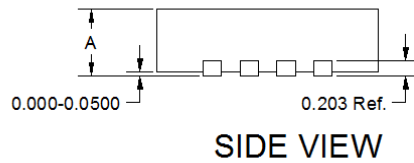
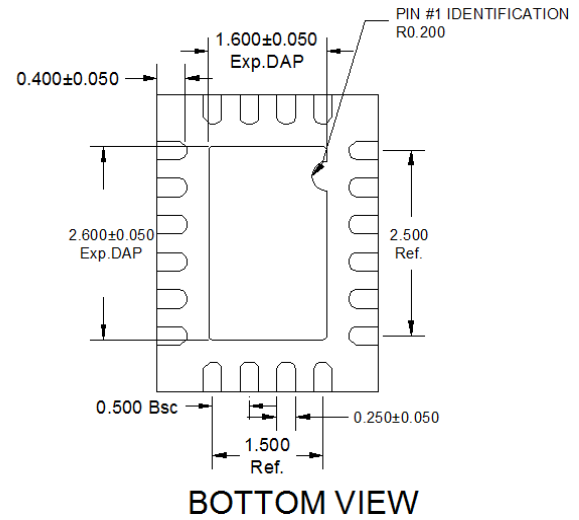
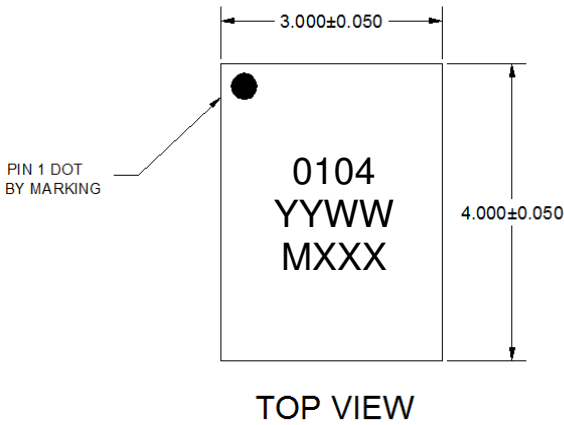

A		QFN
	MAX.	0.900
	NOM.	0.850
	MIN.	0.800

Notes:  
 1. All dimensions are in millimeters. Angles are in degrees.

## PCB Mounting Pattern

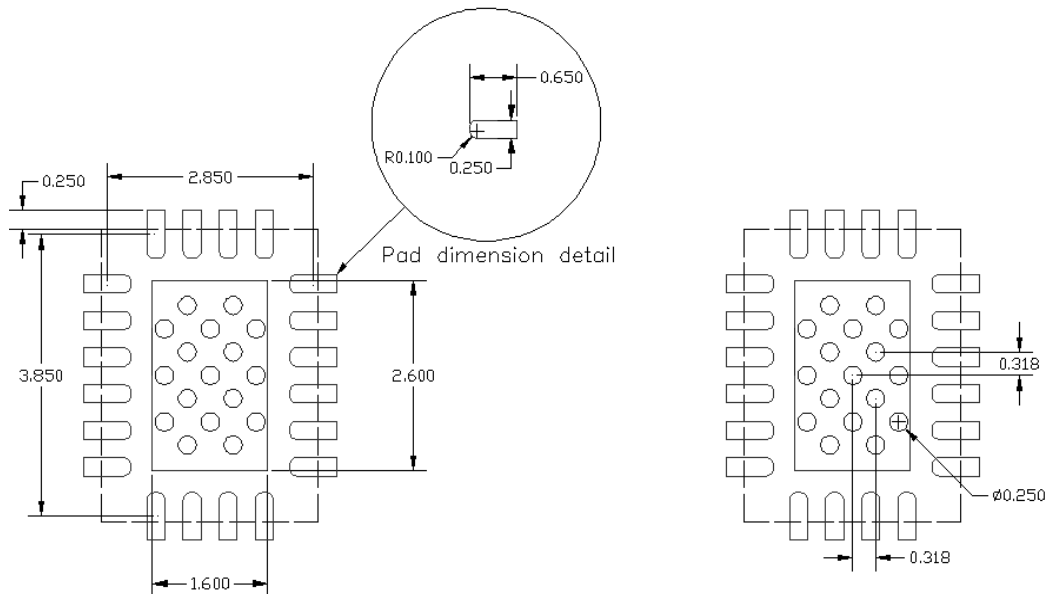

Notes:  
 1. All dimensions are in millimeters. Angles are in degrees.

## Product Compliance Information

### ESD Sensitivity Ratings



Caution! ESD-Sensitive Device

ESD Rating: Class 1B  
Value: Passes  $\geq 600$  V  
Test: Human Body Model (HBM)  
Standard: JEDEC Standard JS-001-2012

ESD Rating: Class C3  
Value: Passes  $\geq 1000$  V  
Test: Charged Device Model (CDM)  
Standard: JEDEC Standard JESD22-C101F

### MSL Rating

MSL Rating: Level 3  
Test: 260°C convection reflow  
Standard: JEDEC Standard IPC/JEDEC J-STD-020D.1

### ECCN

US Department of Commerce EAR99

### Solderability

Compatible with both lead-free (260°C maximum reflow temperature) and tin/lead (245°C maximum reflow temperature) soldering processes.

Contact plating: NiPdAu

### RoHS Compliance

This part is compliant with EU 2002/95/EC RoHS directive (Restrictions on the Use of Certain Hazardous Substances in Electrical and Electronic Equipment).

This product also has the following attributes:

- Lead Free
- Halogen Free (Chlorine, Bromine)
- Antimony Free
- TBBP-A (C<sub>15</sub>H<sub>12</sub>Br<sub>4</sub>O<sub>2</sub>) Free
- PFOS Free
- SVHC Free

## Contact Information

For the latest specifications, additional product information, worldwide sales and distribution locations, and information about TriQuint:

Web: [www.triquint.com](http://www.triquint.com)  
Email: [info-sales@triquint.com](mailto:info-sales@triquint.com)

Tel: +1.972.994.8465  
Fax: +1.972.994.8504

For technical questions and application information: Email: [btsapplications@tqs.com](mailto:btsapplications@tqs.com)

## Important Notice

The information contained herein is believed to be reliable. TriQuint makes no warranties regarding the information contained herein. TriQuint assumes no responsibility or liability whatsoever for any of the information contained herein. TriQuint assumes no responsibility or liability whatsoever for the use of the information contained herein. The information contained herein is provided "AS IS, WHERE IS" and with all faults, and the entire risk associated with such information is entirely with the user. All information contained herein is subject to change without notice. Customers should obtain and verify the latest relevant information before placing orders for TriQuint products. The information contained herein or any use of such information does not grant, explicitly or implicitly, to any party any patent rights, licenses, or any other intellectual property rights, whether with regard to such information itself or anything described by such information.

TriQuint products are not warranted or authorized for use as critical components in medical, life-saving, or life-sustaining applications, or other applications where a failure would reasonably be expected to cause severe personal injury or death.