

1 Watt DC-4 GHz Packaged HFET

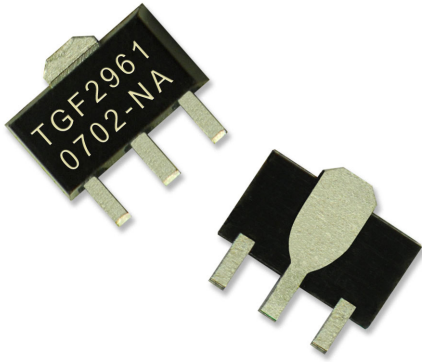

900 MHz Application Board Performance

Bias conditions: $V_d = 8\text{ V}$, $I_{dq} = 200\text{ mA}$, $V_g = -1.0\text{ V}$ Typical

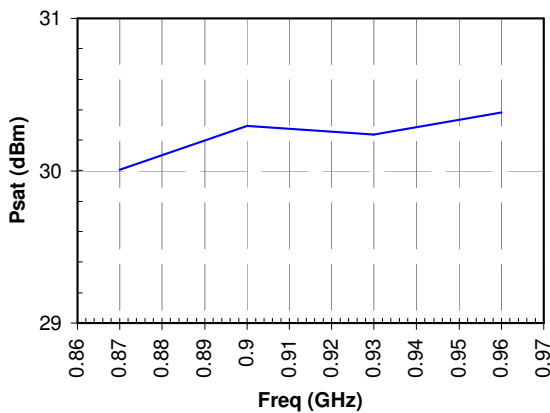
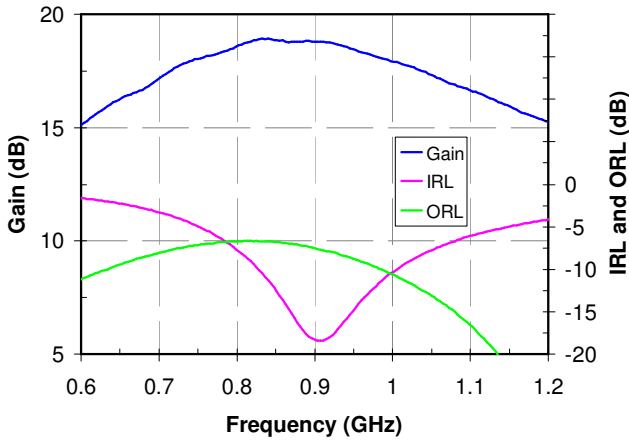

Key Features

- Frequency Range: DC-4 GHz
- Nominal 900 MHz Application Board Performance:
 - TOI: 44 dBm
 - 31 dBm Psat, 30 dBm P1dB
 - Gain: 18 dB
 - Input Return Loss: -15 dB
 - Output Return Loss: -7 dB
 - Bias: $V_d = 8\text{ V}$, $I_d = 200\text{ mA}$, $V_g = -1.0\text{ V}$ (Typical)
 - Package Dimensions: 4.5 x 4 x 1.5 mm

Primary Applications

- Cellular Base Stations
- WiMAX
- Wireless Infrastructure
- IF & LO Buffer Applications
- RFID

Product Description

The TGF2961-SD is a high performance 1-watt Heterojunction GaAs Field Effect Transistor (HFET) housed in a low cost SOT89 surface mount package.

The device's ideal operating point is at a drain bias of 8 V and 200 mA. At this bias at 900 MHz when matched into 50 ohms using external components, this device is capable of 18 dB of gain, 30 dBm of saturated output power, and 44 dBm of output IP3

Evaluation boards at 900 MHz, 1900 MHz and 2100 MHz available on request.

RoHS and Lead-Free compliant

Datasheet subject to change without notice.

Table I
Absolute Maximum Ratings 1/

Symbol	Parameter	Value	Notes
Vd-Vg	Drain to Gate Voltage	17 V	
Vd	Drain Voltage	9 V	2/
Vg	Gate Voltage Range	-5 to 0 V	
Id	Drain Current	780 mA	2/
Ig	Gate Current Range	-2.4 to 17.8 mA	
Pin	Input Continuous Wave Power	29 dBm	2/

- 1/ These ratings represent the maximum operable values for this device. Stresses beyond those listed under "Absolute Maximum Ratings" may cause permanent damage to the device and / or affect device lifetime. These are stress ratings only, and functional operation of the device at these conditions is not implied.
- 2/ Combinations of supply voltage, supply current, input power, and output power shall not exceed the maximum power dissipation listed in Table IV.

Table II
Recommended Operating Conditions

Symbol	Parameter 1/	Typical Value
Vd	Drain Voltage	8 V
Idq	Drain Current	200 mA
Id	Drain Current at Psat	260 mA
Vg	Gate Voltage	-1.0 V

- 1/ See assembly diagram for bias instructions.

Table III
RF Characterization Table

Bias: Vd = 8 V, Idq = 200 mA, Vg = -1.0 V, typical

SYMBOL	PARAMETER	TEST CONDITIONS	NOMINAL	UNITS	NOTES
Gain	Small Signal Gain	900 MHz	18	dB	1/
		1900 MHz	15		2/
		2100 MHz	15		3/
IRL	Input Return Loss	900 MHz	-15	dB	1/
		1900 MHz	-15		2/
		2100 MHz	-15		3/
ORL	Output Return Loss	900 MHz	-6	dB	1/
		1900 MHz	-6		2/
		2100 MHz	-6		3/
Psat	Saturated Output Power	900 MHz	30.5	dBm	1/
		1900 MHz	31		2/
		2100 MHz	31		3/
P1dB	Output Power @ 1dB Compression	900 MHz	29.5	dBm	1/
		1900 MHz	30		2/
		2100 MHz	30		3/
TOI	Output TOI	900 MHz	44	dBm	1/
		1900 MHz	44		2/
		2100 MHz	44		3/
NF	Noise Figure	900 MHz	3.3	dB	1/
		1900 MHz	4.3		2/
		2100 MHz	4.3		3/

- 1/ Using 900 MHz Application Board.
- 2/ Using 1900 MHz Application Board
- 3/ Using 2100 MHz Application Board

Table IV
Power Dissipation and Thermal Properties

Parameter	Test Conditions	Value	Notes
Maximum Power Dissipation	Tbaseplate = 70 °C	Pd = 2.7 W Tchannel = 175 °C Tm = 8.7E+06 Hrs	1/ 2/
Thermal Resistance, θ_{jc}	Vd = 8 V Id = 200 mA Pd = 1.6 W Tbaseplate = 85 °C	θ_{jc} = 39 (°C/W) Tchannel = 147 °C Tm = 1.86E+08 Hrs	
Thermal Resistance, θ_{jc} Under RF Drive	Vd = 8 V Id = 260 mA Pout = 30 dBm Pd = 1.08 W Tbaseplate = 85 °C	θ_{jc} = 39 (°C/W) Tchannel = 127 °C Tm = 2.27E+09 Hrs	
Mounting Temperature	See 'Typical Solder Reflow Profiles' Table		
Storage Temperature		-65 to 150 °C	

- 1/ For a median life of 8.7E6 hours, Power Dissipation is limited to

$$Pd(max) = (175^{\circ}C - Tbase^{\circ}C) / \theta_{jc}$$
- 2/ Channel operating temperature will directly affect the device median time to failure (MTTF). For maximum life, it is recommended that channel temperatures be maintained at the lowest possible levels.

Power De-Rating Curve

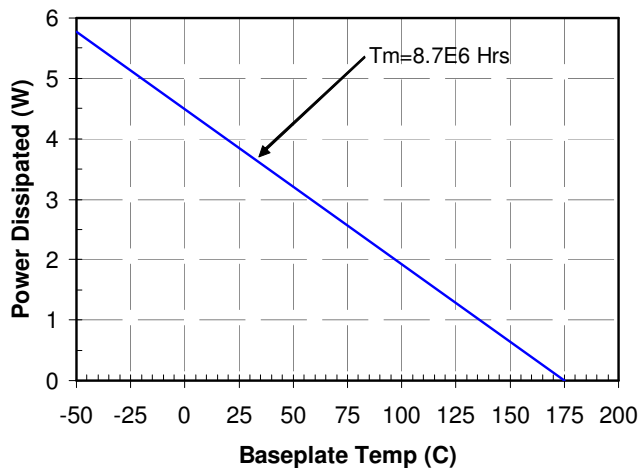

Gmax, Max Stable Gain, K factor

Bias conditions: $V_d = 8\text{ V}$, $I_{dq} = 200\text{ mA}$, $V_g = -1.0\text{ V}$ Typical

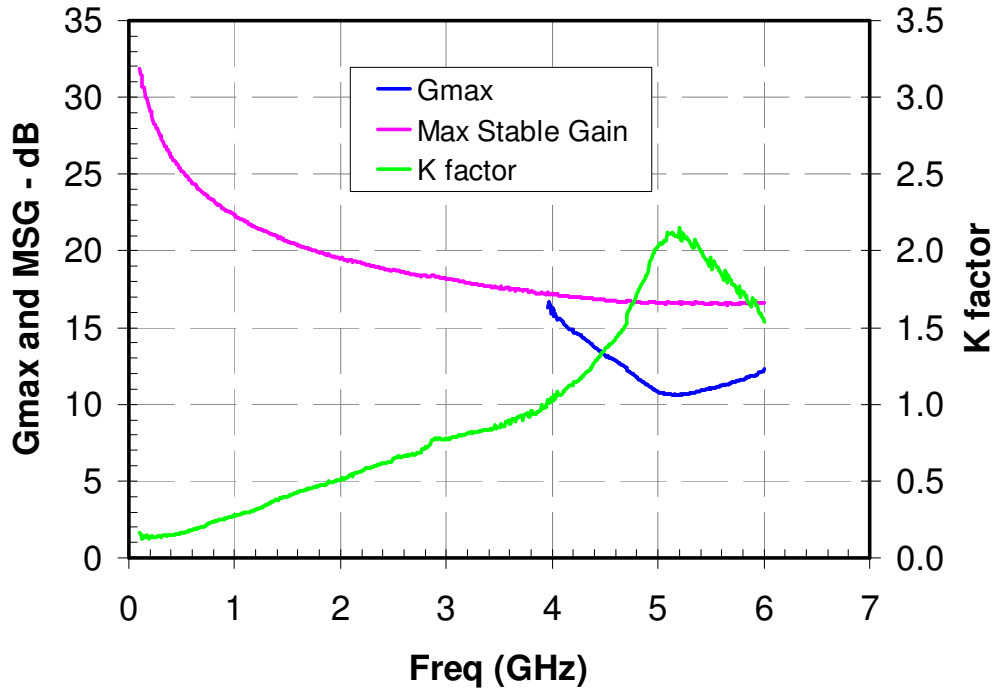

Measured Data 900 MHz Application Board

Bias conditions: $V_d = 8\text{ V}$, $I_d = 200\text{ mA}$, $V_g = -1.0\text{ V}$ Typical

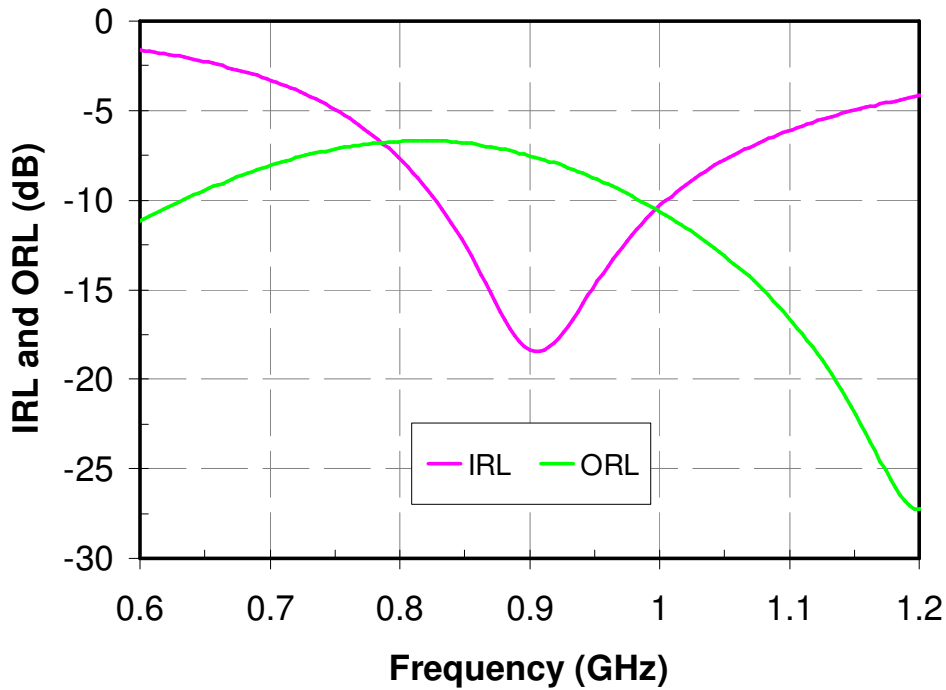
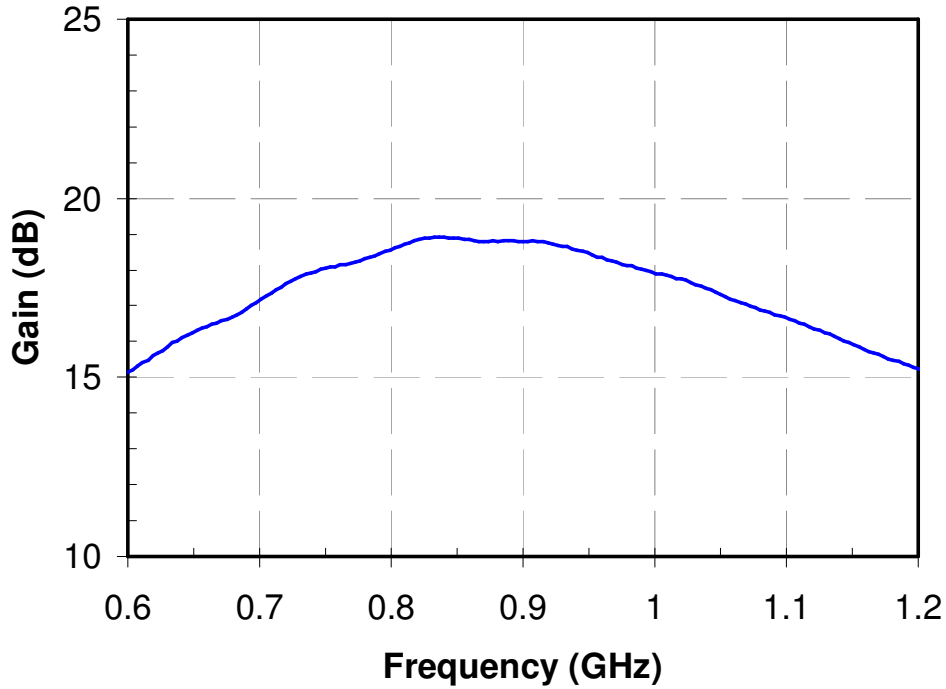

Measured Data 900 MHz Application Board

Bias conditions: $V_d = 8\text{ V}$, $I_{dq} = 200\text{ mA}$, $V_g = -1.0\text{ V}$ Typical

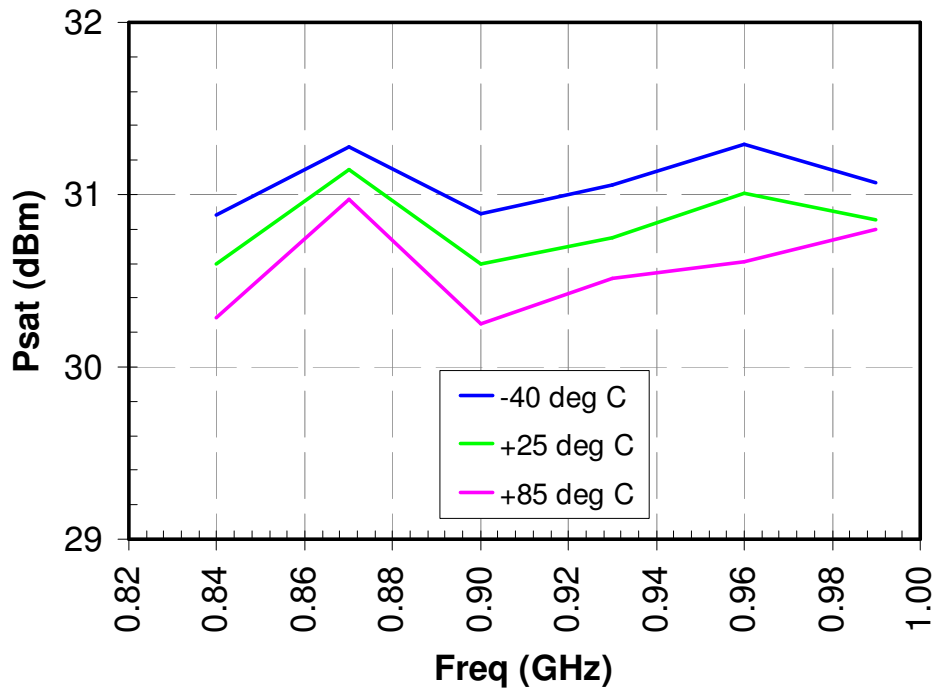
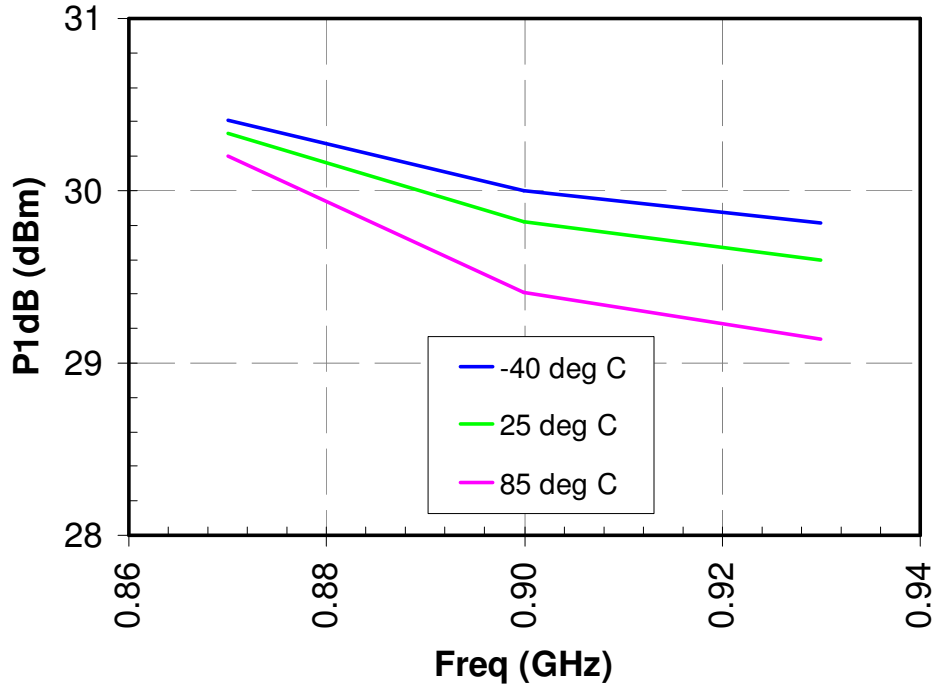

Measured Data 900 MHz Application Board

Bias conditions: $V_d = 8\text{ V}$, $I_{dq} = 200\text{ mA}$, $V_g = -1.0\text{ V}$ Typical

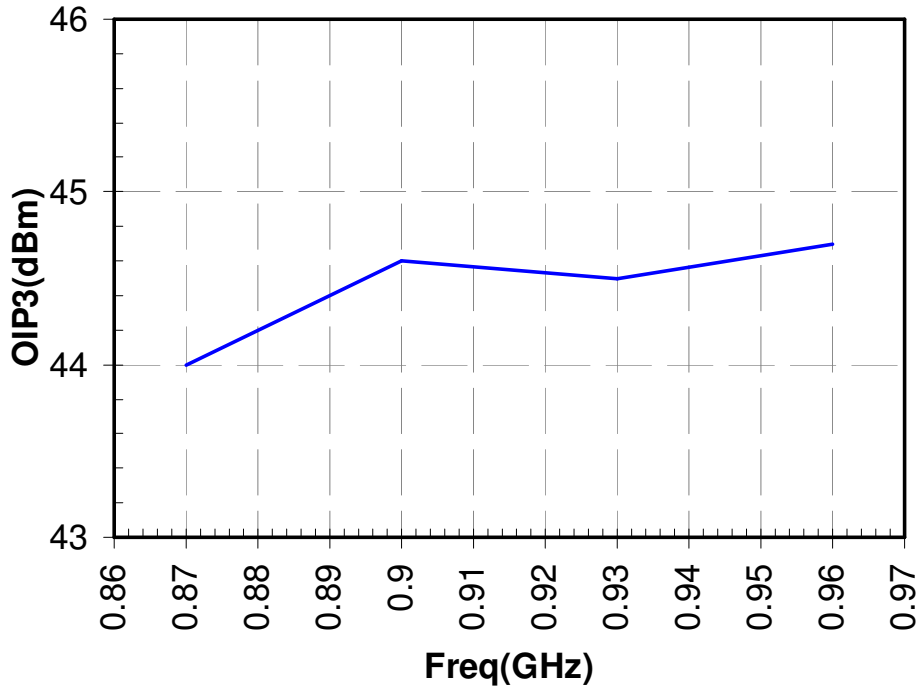

Measured Data 1900 MHz Application Board

Bias conditions: $V_d = 8\text{ V}$, $I_{dq} = 200\text{ mA}$, $V_g = -1.0\text{ V}$ Typical

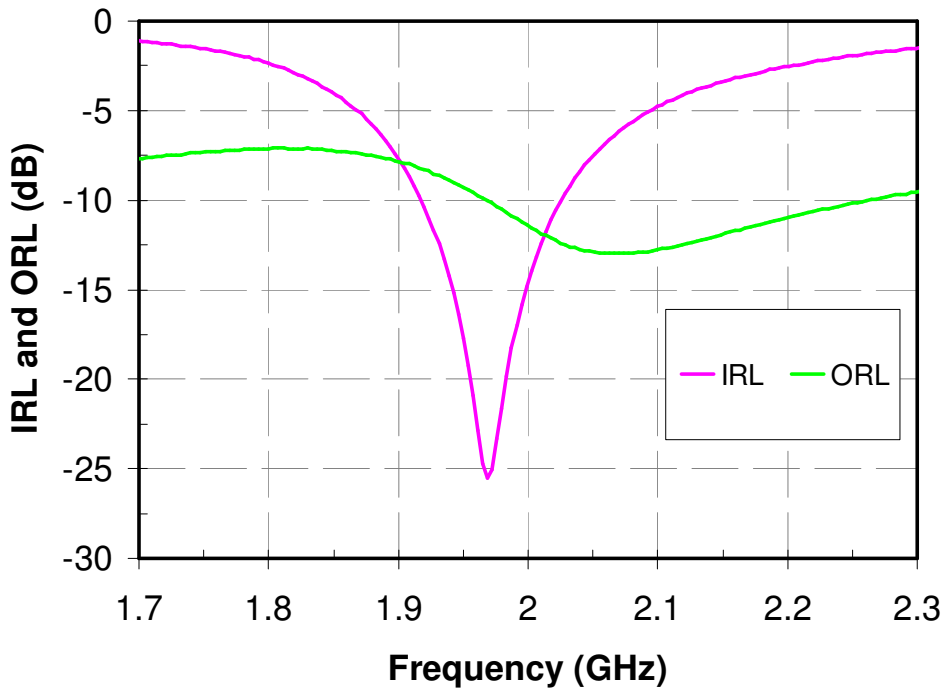
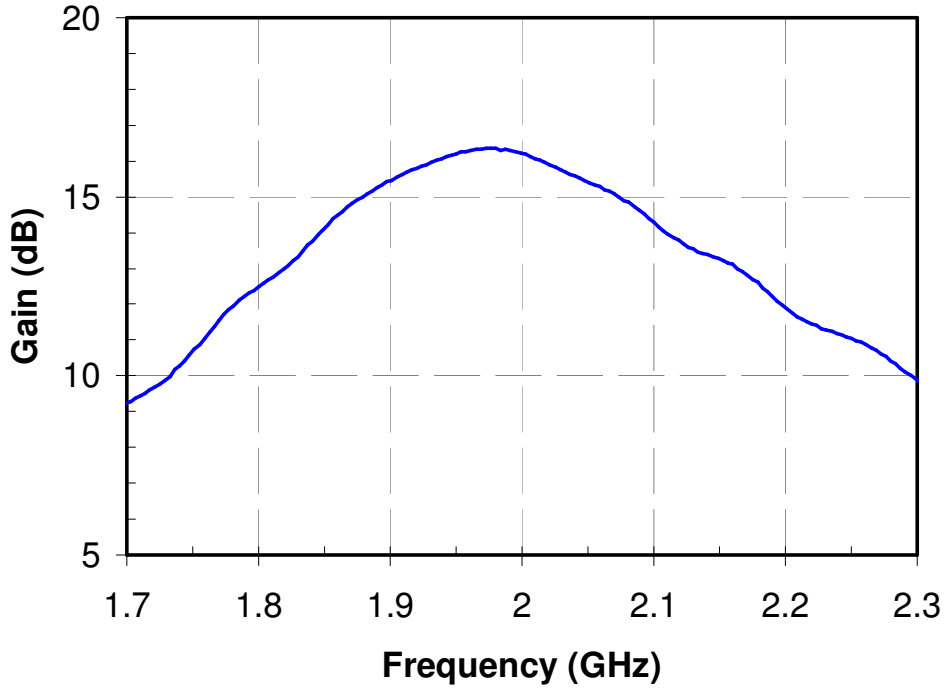

Measured Data 1900 MHz Application Board

Bias conditions: $V_d = 8\text{ V}$, $I_{dq} = 200\text{ mA}$, $V_g = -1.0\text{ V}$ Typical

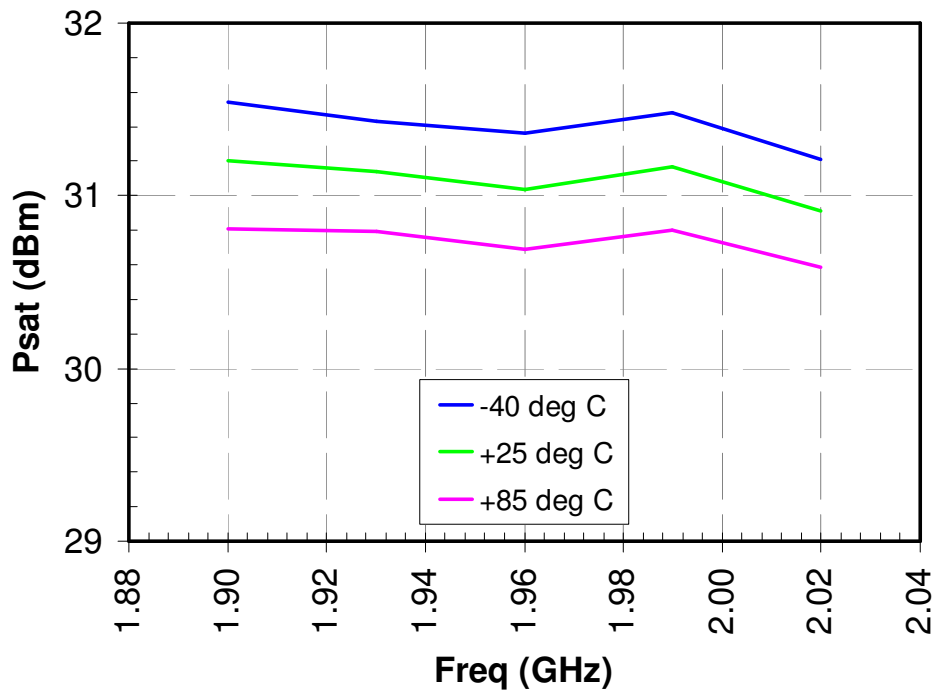
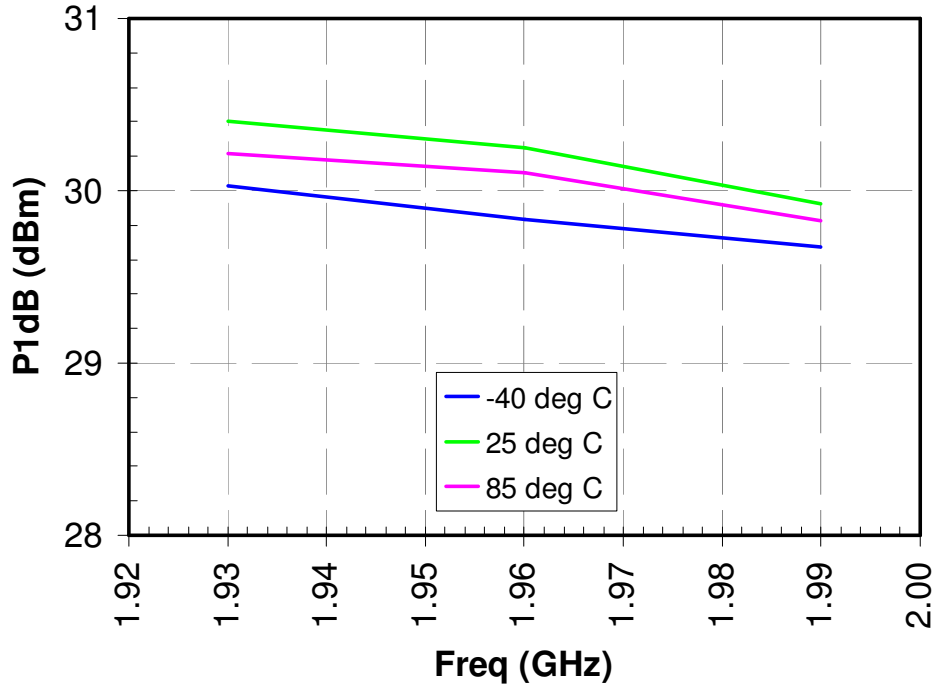

Measured Data 1900 MHz Application Board

Bias conditions: $V_d = 8\text{ V}$, $I_{dq} = 200\text{ mA}$, $V_g = -1.0\text{ V}$ Typical

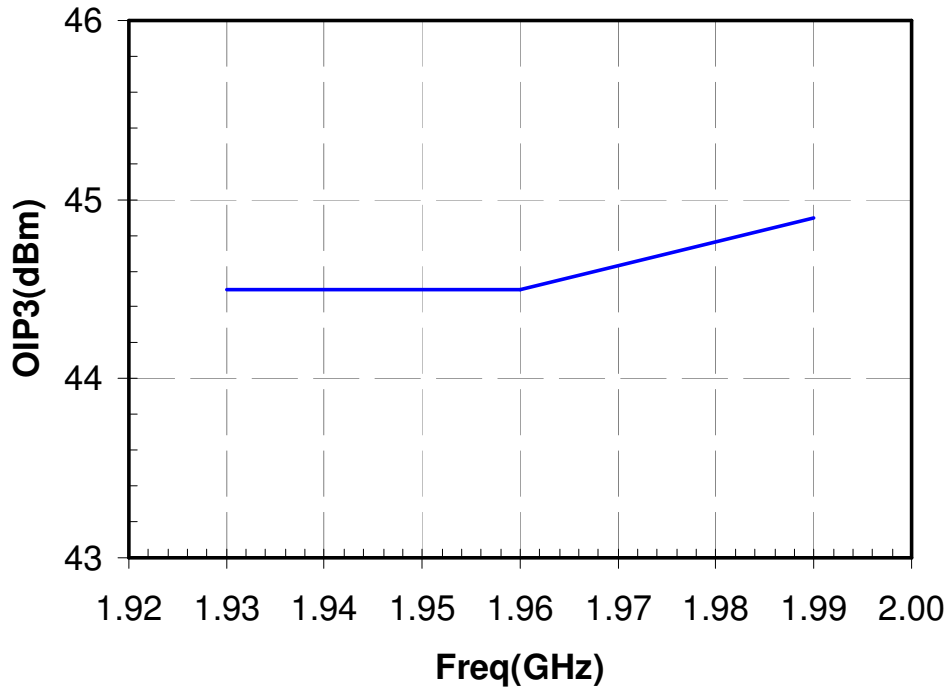

Measured Data 2100 MHz Application Board

Bias conditions: $V_d = 8\text{ V}$, $I_{dq} = 200\text{ mA}$, $V_g = -1.0\text{ V}$ Typical

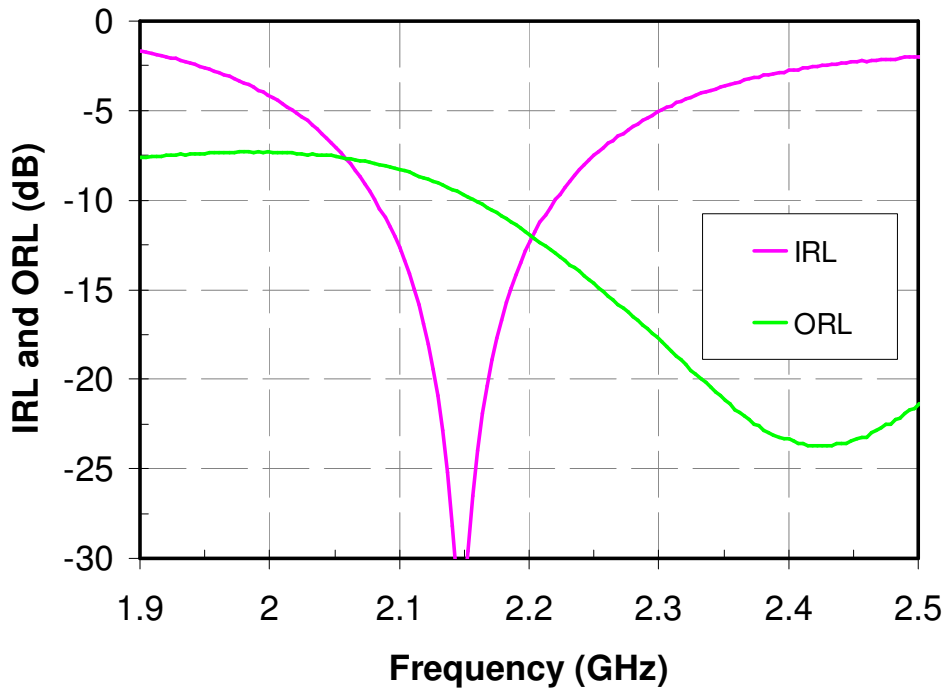
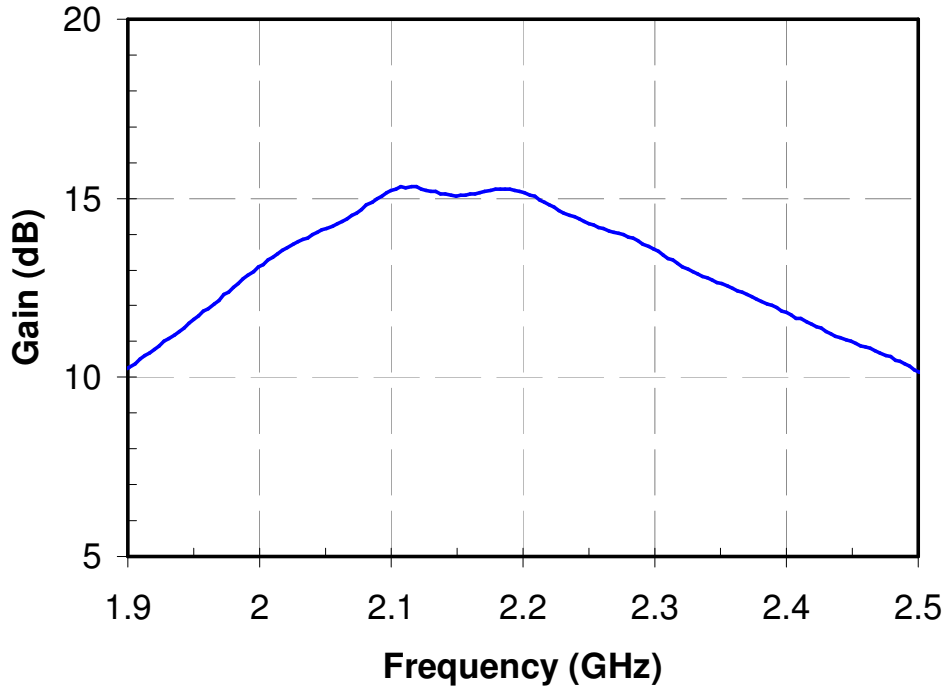

Measured Data 2100 MHz Application Board

Bias conditions: $V_d = 8\text{ V}$, $I_d = 200\text{ mA}$, $V_g = -1.0\text{ V}$ Typical

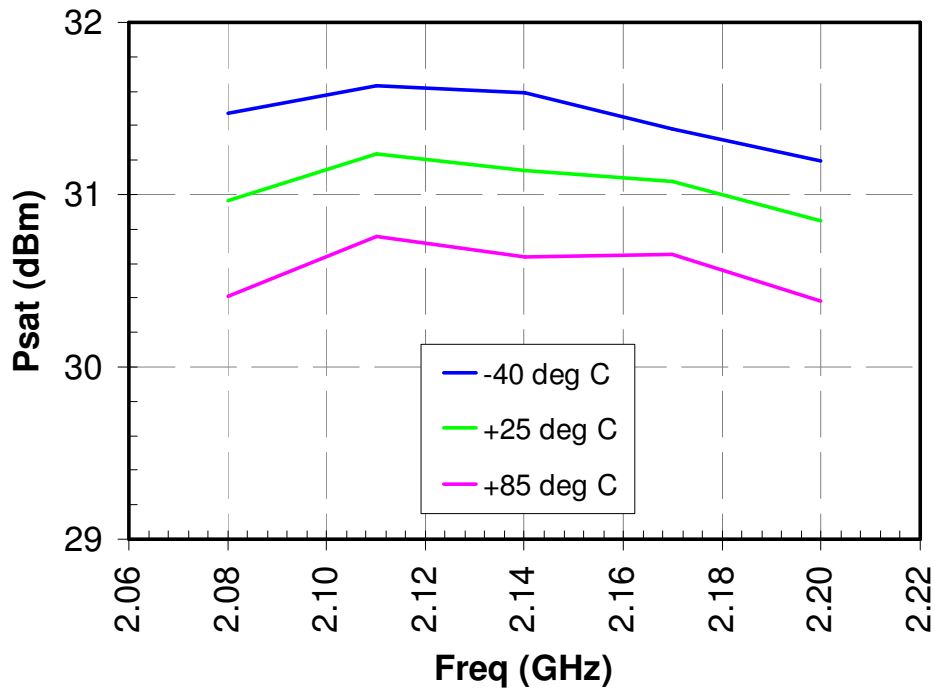
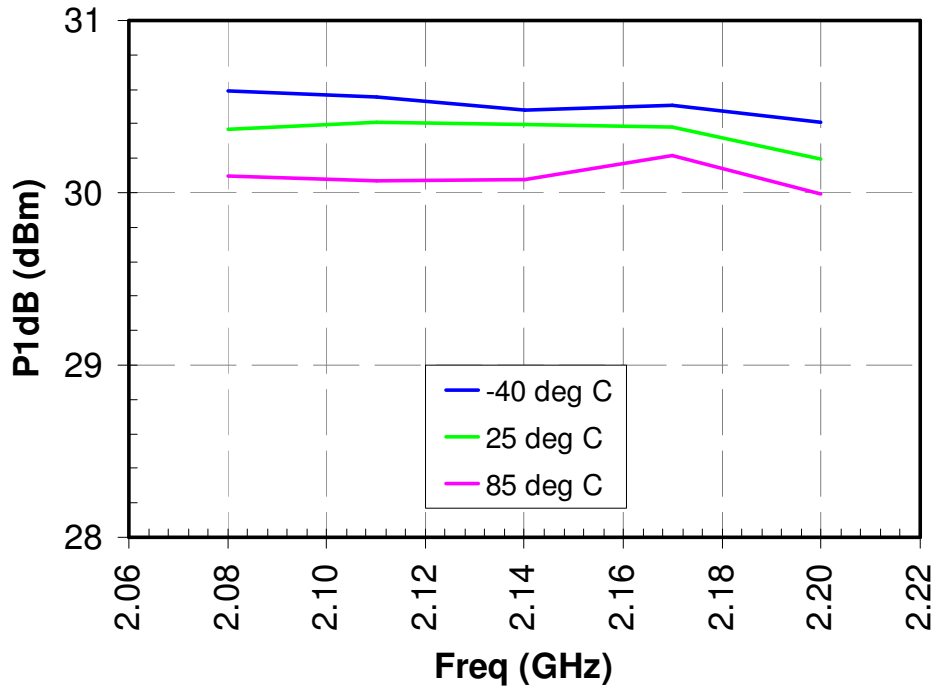

Measured Data 2100 MHz Application Board

Bias conditions: $V_d = 8\text{ V}$, $I_{dq} = 200\text{ mA}$, $V_g = -1.0\text{ V}$ Typical

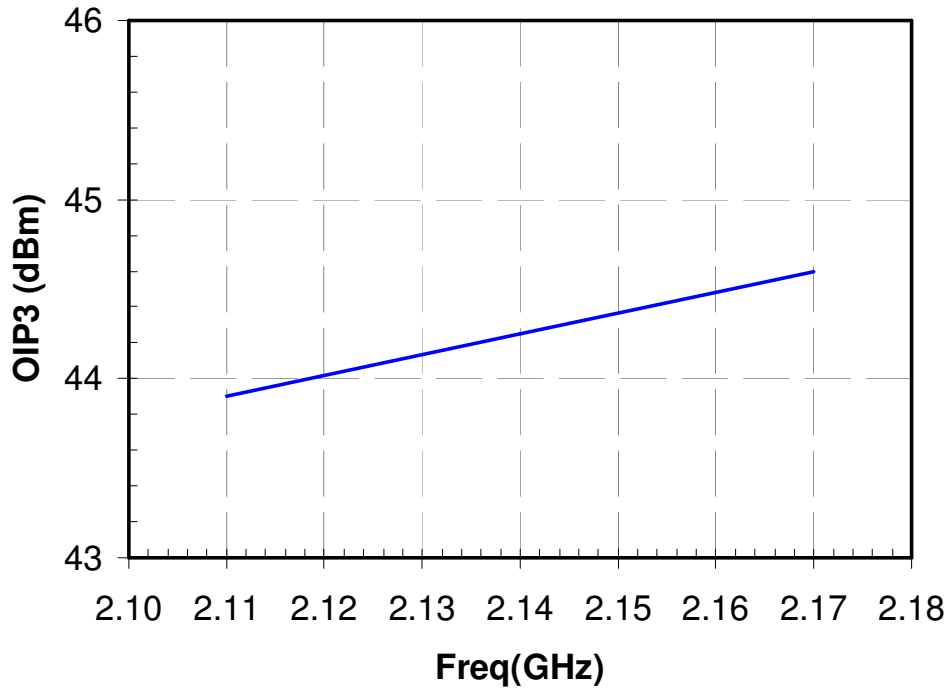

Electrical Schematic

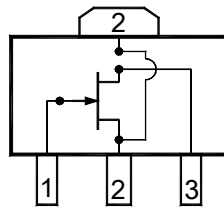

Pin	Signal
1	RF In (Gate)
2	Gnd (Source)
3	RF Out (Drain)

Bias Procedures

Bias-up Procedure

- Vg set to -2.5 V
- Vd set to +8 V
- Adjust Vg more positive until Idq is 200 mA. This will be ~ Vg = -1.0 V
- Apply RF signal to input

Bias-down Procedure

- Turn off RF signal at input
- Reduce Vg to -2.5V. Ensure Id ~ 0 mA
- Turn Vd to 0 V
- Turn Vg to 0 V

Mechanical Drawing

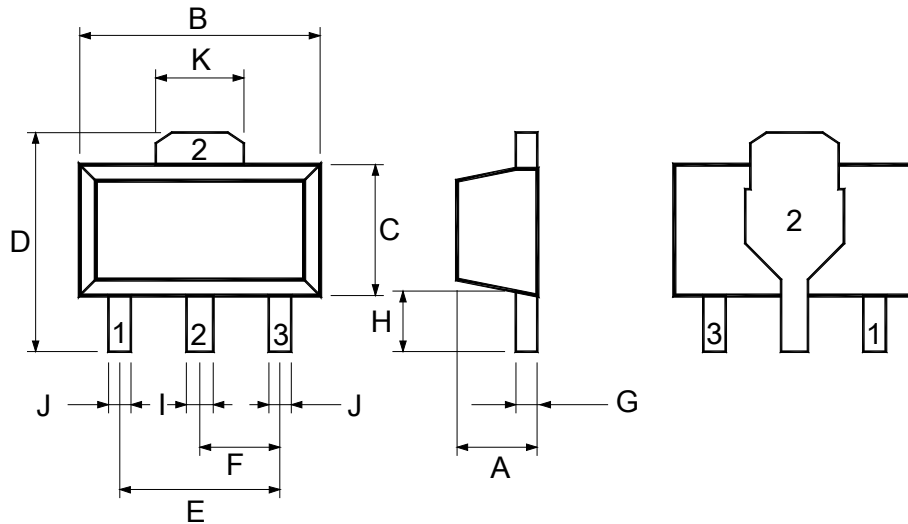

Dim	Millimeters	
	Min	Max
A	1.40	1.60
B	4.40	4.60
C	2.29	2.60
D	3.94	4.25
E	3.00 Center-Center	
F	1.50 Center-Center	
G	0.35	0.44
H	0.89	1.20
I	0.44	0.56
J	0.36	0.48
K	1.50	1.83

GaAs MMIC devices are susceptible to damage from Electrostatic Discharge. Proper precautions should be observed during handling, assembly and test.

Evaluation Board

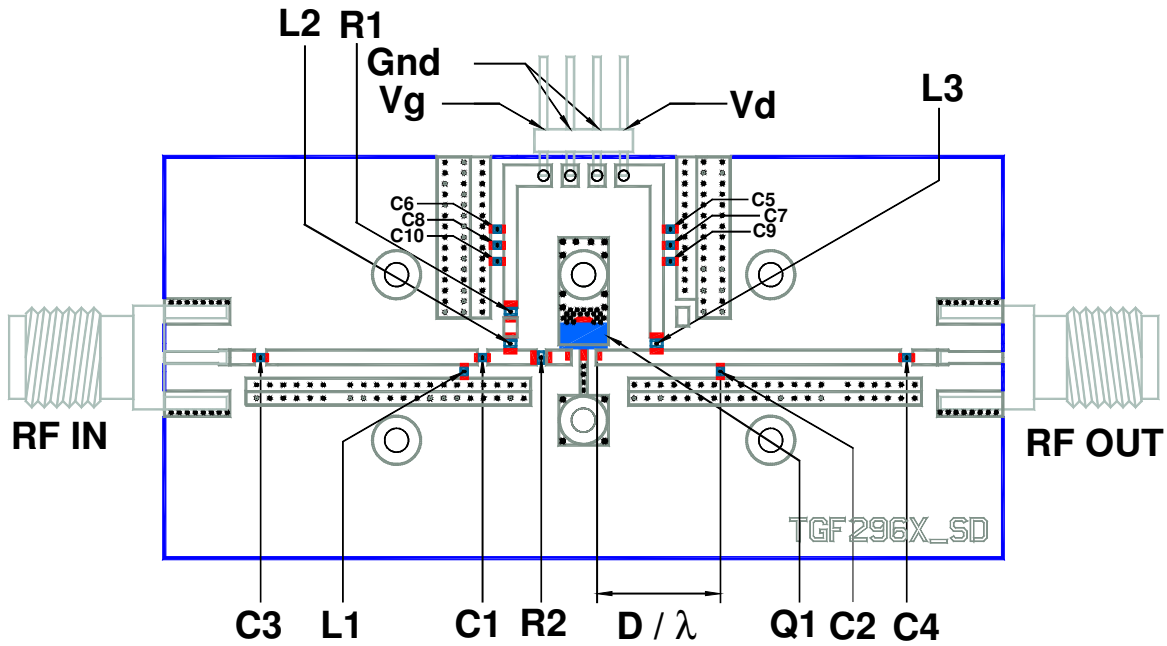

Evaluation Board Schematic

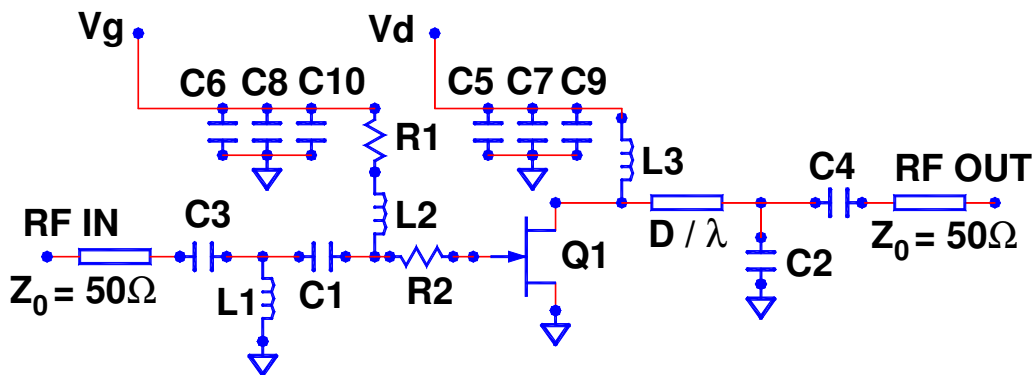

GaAs MMIC devices are susceptible to damage from Electrostatic Discharge. Proper precautions should be observed during handling, assembly and test.

Evaluation Board Bill of Materials

Ref Des	Value for Freq (MHz)			Description
	900	1900	2100	
L1	5.6 nH	1.2 nH	1.2 nH	0603 ACCU-L AVX Inductor
C1	8.2 pF	1.2 pF	0.9 pF	0603 ACCU-P AVX Capacitor
C2	1.8 pF	1.2 pF	1.2 pF	0603 ACCU-P AVX Capacitor
D	18.8 mm	8.0 mm	5.2 mm	Physical Location for C2
λ	36°@0.9 GHz	33°@1.9 GHz	23°@2.1 GHz	50 Ohm Transmission Line Length D
L2, L3	50 nH			0805 Inductor
C3,C4	150 pF			0603 Capacitor
C5, C6	0.1 μ F			0603 Capacitor
C7, C8	0.01 μ F			0603 Capacitor
C9, C10	1000 pF			0603 Capacitor
R1	50 Ohm			0805 1/8 Watt Resistor
R2	3 Ohm			0805 1/8 Watt Resistor
Q1	--			TriQuint TGF2961-SD Packaged FET
(PCB)	--			28 mil thick GETEK

GaAs MMIC devices are susceptible to damage from Electrostatic Discharge. Proper precautions should be observed during handling, assembly and test.

Recommended Assembly Diagram

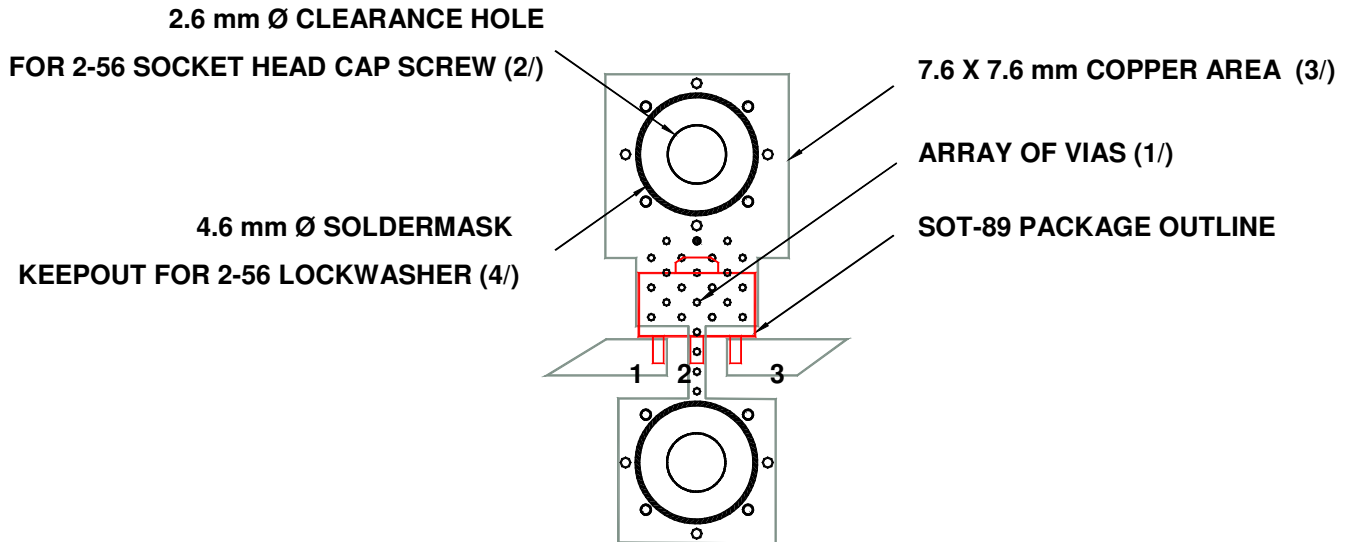

Assembly Notes

1/ The lowest possible thermal and electrical resistance for Pin 2 is critical for optimal performance. The array of vias under Pin 2 should be as small and as dense as the PC board fabrication permits. 0.30 mm diameter vias on 0.60 mm center to center spacing is recommended.

2/ Mounting screws in the vicinity of the package improve heat transfer to the chassis or to a heat spreader located on the backside of the PC board. Shown are clearance holes and solder mask keepout zone for a 2-56 socket head cap screw. Use of a split lockwasher and proper torque on the screw will prevent compression damage to the PC board.

3/ Use of 1 oz copper (min) in the PC board construction is recommended.

4/ For lowest thermal resistance, solder mask must be removed where the copper traces on the PC board contact the heat spreader. In this example, this would be a) front and backsides of the PC board around the 2-56 screw and b) front of the PC board around package pin 2.

GaAs MMIC devices are susceptible to damage from Electrostatic Discharge. Proper precautions should be observed during handling, assembly and test.

Recommended Surface Mount Package Assembly

Proper ESD precautions must be followed while handling packages.

Clean the board with acetone. Rinse with alcohol. Allow the circuit to fully dry.

TriQuint recommends using a conductive solder paste for attachment. Follow solder paste and reflow oven vendors' recommendations when developing a solder reflow profile. Typical solder reflow profiles are listed in the table below.

Hand soldering is not recommended. Solder paste can be applied using a stencil printer or dot placement. The volume of solder paste depends on PCB and component layout and should be well controlled to ensure consistent mechanical and electrical performance.

Clean the assembly with alcohol.

Typical Solder Reflow Profiles

Reflow Profile	SnPb	Pb Free
Ramp-up Rate	3 °C/sec	3 °C/sec
Activation Time and Temperature	60 – 120 sec @ 140 – 160 °C	60 – 180 sec @ 150 – 200 °C
Time above Melting Point	60 – 150 sec	60 – 150 sec
Max Peak Temperature	240 °C	260 °C
Time within 5 °C of Peak Temperature	10 – 20 sec	10 – 20 sec
Ramp-down Rate	4 – 6 °C/sec	4 – 6 °C/sec

Ordering Information

Part	Package Style
TGF2961-SD, TAPE AND REEL	SOT-89, TAPE AND REEL