

Applications

- Defense & Aerospace
- High-Reliability
- Test and Measurement
- Commercial
- Broadband Wireless

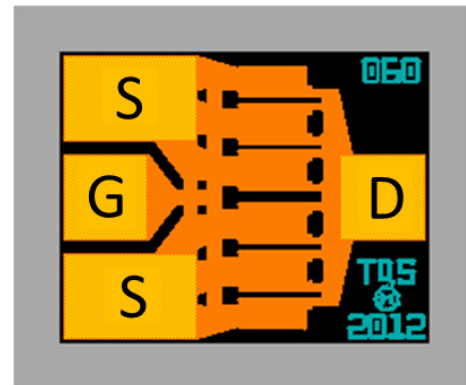

Product Features

- Frequency Range: DC - 20 GHz
- 28 dBm Typical Output Power - P1dB
- 12 dB Typical Gain at 12 GHz
- 55% Typical PAE at 12 GHz
- 1.4 dB Typical NF at 12 GHz
- No Vias
- Technology: 0.25 um GaAs pHEMT
- Chip Dimensions: 0.41 x 0.34 x 0.10 mm

Functional Block Diagram

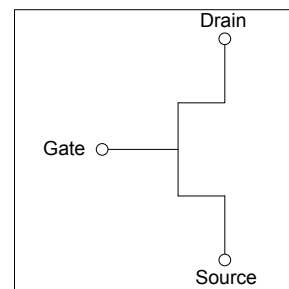

General Description

The TriQuint TGF2060 is a discrete 600 micron pHEMT which operates from DC to 20 GHz. The TGF2060 is fabricated using TriQuint's proven standard 0.25 um power pHEMT production process. This process features advanced techniques to optimize microwave power and efficiency at high drain bias operating conditions.

The TGF2060 typically provides 28 dBm of output power at P1dB with gain of 12 dB and 55% power-added efficiency at 1 dB compression. This performance makes the TGF2060 appropriate for high efficiency applications. The protective overcoat layer with silicon nitride provides a level of environmental robustness and scratch protection.

The TGF2060 is lead-free and RoHS compliant.

Pad Configuration

Pad Dimensions	Terminals
G (71um X 71um)	Gate
D (71um X 71um)	Drain
S (121um X 71um)	Source

Ordering Information

Part	ECCN	Description
TGF2060	EAR99	600 um GaAs pHEMT

Absolute Maximum Ratings

Symbol	Parameter	Absolute	Continuous	Units
V_{DS}	Drain-Source Voltage ⁽²⁾	12	8	V
V_{GS}	Gate- Source Voltage	-7	-3	V
I_{DS}	Drain Current ⁽²⁾	I_{DSS}	I_{DSS}	mA
$I_{G,F}$	Forward Gate Current	30	5	mA
T_{CH}	Channel Temperature ⁽³⁾	175 ⁽⁴⁾	150 ⁽⁵⁾	°C
T_{STG}	Storage Temperature	-65 to 150	-65 to 150	°C
P_{IN}	Input Continuous Wave Power ⁽²⁾	24	at 3 dB Compression	dBm
P_{TOT}	Total Power Dissipation	3.2	2.1	W

Notes:

1. These ratings represent the maximum operable values for this device. Stresses beyond those listed under “Absolute Maximum Ratings” may cause permanent damage to the device and/or affect device lifetime. These are stress ratings only, and functional operation of the device at these conditions is not implied.
2. Combinations of supply voltage, supply current, input power, and output power shall not exceed the maximum total power dissipation listed in the table.
3. Junction operating temperature will directly affect the device median time to failure. For maximum life, it is recommended that junction temperatures be maintained at the lowest possible levels.
4. When operated at this channel temperature, the median life is 1.0E+5 hours.
5. When operated at this channel temperature, the median life is 1.0E+6 hours.

Electrical Characteristics

Test conditions unless otherwise noted: Temperature = 25°C

Symbol	Parameter	Conditions	Min	Typ	Max	Units
P1dB	Output Power at 1dB Compression	Freq = 12 GHz		28		dBm
G1dB	Gain at P1dB	$V_{DS} = 8V$		12		dB
PAE	PAE at P1dB	$I_{DS} = 50\% I_{DSS}$		55		%
NF	50 ohm Noise Figure	Freq.=12 GHz, $V_{DS} = 3V$, $I_{DS} = 25 mA$		1.4		dB
I_{DSS}	Saturated Drain Current	$V_{DS} = 2V$, $V_{GS} = 0V$	120	194 ⁽¹⁾	268	mA
Gm	Transconductance	$V_{DS} = 2V$, $I_{DS} = 50\% I_{DSS}$		232		mS
V_P	Pinch-Off Voltage	$V_{DS} = 2V$, $I_{DS} = 0.60 mA$	-1.5	-1.0	-0.5	V
BV_{GD}	Gate-Drain Breakdown Voltage	$I_G = 0.60 mA$, source open		-15	-12	V
BV_{GS}	Gate-Source Breakdown Voltage	$I_G = 0.60 mA$, drain open		-15		V
R_{TH}	Thermal Resistance ⁽²⁾	AuSn eutectic attach		54		°C/W

Notes:

1. Typical Standard Deviation of 2 mA (1 σ).
2. Based on IR Scan

S-Parameters

Test Conditions: $V_{DS}=+8$ V (typ.), $I_{DS}=50\%$ I_{DSS} , Temp= $+25^{\circ}\text{C}$, 50Ω system

Freq (GHz)	S11 (mag)	S11 (ang)	S21 (mag)	S21 (ang)	S12 (mag)	S12 (ang)	S22 (mag)	S22 (ang)
1	0.94	-58.2	13.57	144.2	0.029	57.8	0.47	-32.5
2	0.89	-100.4	10.40	119.8	0.045	37.8	0.38	-55.4
3	0.86	-128.2	7.99	103.0	0.051	25.1	0.31	-70.2
4	0.84	-147.9	6.35	90.2	0.054	16.5	0.26	-81.8
5	0.83	-162.5	5.21	79.7	0.055	10.2	0.24	-91.5
6	0.83	-174.1	4.38	70.7	0.055	5.4	0.23	-99.7
7	0.84	176.3	3.77	62.5	0.055	1.6	0.23	-106.8
8	0.84	167.9	3.29	55.0	0.055	-1.5	0.23	-113.7
9	0.84	160.4	2.90	47.9	0.054	-4.3	0.23	-121.0
10	0.85	153.8	2.58	41.2	0.052	-6.5	0.24	-127.5
11	0.85	147.9	2.31	34.9	0.051	-7.9	0.25	-133.2
12	0.86	142.4	2.09	28.5	0.050	-9.2	0.26	-138.9
13	0.86	137.6	1.90	22.3	0.049	-10.1	0.28	-144.0
14	0.87	133.2	1.74	16.3	0.048	-10.6	0.29	-149.7
15	0.88	128.6	1.61	10.7	0.047	-10.3	0.31	-154.5
16	0.89	124.3	1.48	5.1	0.047	-10.0	0.33	-159.1
17	0.90	120.6	1.37	-0.2	0.047	-9.6	0.35	-164.6
18	0.90	116.7	1.27	-5.7	0.046	-9.5	0.37	-169.5
19	0.89	113.4	1.17	-10.5	0.046	-8.0	0.39	-173.8
20	0.91	110.9	1.10	-15.6	0.048	-7.4	0.42	-178.0
21	0.92	107.2	1.03	-20.7	0.048	-7.1	0.44	177.2
22	0.94	104.3	0.96	-25.8	0.049	-7.0	0.46	173.4
23	0.93	101.4	0.90	-30.9	0.050	-7.2	0.48	169.0
24	0.94	98.5	0.84	-35.5	0.052	-6.4	0.50	165.2
25	0.94	96.0	0.79	-40.2	0.053	-6.7	0.52	161.0
26	0.94	93.3	0.74	-44.7	0.055	-7.5	0.53	157.2

Includes 1 bond wire on Gate, 1 bond wire on Drain, and 3 bond wires on each Source pad.

Noise Parameters

$V_{DS} = 2\text{ V}$, $I_{DS} = 96\text{ mA}$, Temp. = 25°C

Frequency	NFmin	Rn/50	Gamma	
GHz	dB	Ω	Mag.	Angle
2	0.44	0.093	0.45	49.9
3	0.48	0.085	0.47	65.6
4	0.53	0.076	0.49	84.5
5	0.60	0.066	0.51	103.8
6	0.71	0.056	0.53	121.0
7	0.80	0.046	0.55	136.3
8	0.89	0.037	0.57	149.8
9	0.98	0.032	0.58	161.7
10	1.05	0.029	0.60	172.1
11	1.13	0.031	0.61	-178.9
12	1.22	0.038	0.62	-171.0
13	1.33	0.051	0.63	-164.2
14	1.47	0.070	0.64	-158.3
15	1.58	0.095	0.64	-153.1
16	1.73	0.126	0.64	-148.6
17	1.86	0.162	0.65	-144.5
18	2.01	0.203	0.65	-140.8
19	2.12	0.249	0.64	-137.2
20	2.29	0.309	0.64	-133.6
21	2.44	0.390	0.64	-129.9
22	2.67	0.488	0.63	-126.0
23	2.89	0.615	0.62	-121.7
24	3.09	0.761	0.61	-116.8
25	3.25	0.921	0.60	-111.9
26	3.32	1.062	0.60	-107.8

$V_{DS} = 2\text{ V}$, $I_{DS} = 48\text{ mA}$, Temp. = 25°C

Frequency	NFmin	Rn/50	Gamma	
GHz	dB	Ω	Mag.	Angle
2	0.38	0.083	0.50	34.7
3	0.39	0.076	0.50	50.7
4	0.40	0.069	0.51	69.9
5	0.43	0.060	0.51	89.7
6	0.52	0.052	0.52	107.4
7	0.59	0.042	0.53	123.3
8	0.66	0.035	0.53	137.5
9	0.73	0.031	0.54	150.1
10	0.77	0.027	0.54	161.3
11	0.83	0.027	0.55	171.1
12	0.87	0.029	0.56	179.7
13	0.93	0.034	0.56	-172.7
14	1.02	0.043	0.57	-166.1
15	1.11	0.055	0.58	-160.3
16	1.21	0.072	0.58	-155.2
17	1.29	0.091	0.59	-150.6
18	1.35	0.109	0.60	-146.4
19	1.38	0.130	0.60	-142.5
20	1.45	0.157	0.61	-138.7
21	1.57	0.194	0.62	-134.9
22	1.69	0.240	0.62	-131.1
23	1.84	0.296	0.63	-127.0
24	1.91	0.363	0.64	-122.5
25	1.97	0.441	0.64	-118.1
26	1.97	0.504	0.65	-114.5

RF Tuned Data at 12 GHz

Bias conditions unless otherwise noted: $V_D = 8\text{ V}$, $I_{DQ} = 50\% I_{DSS}$, $F = 12\text{ GHz}$

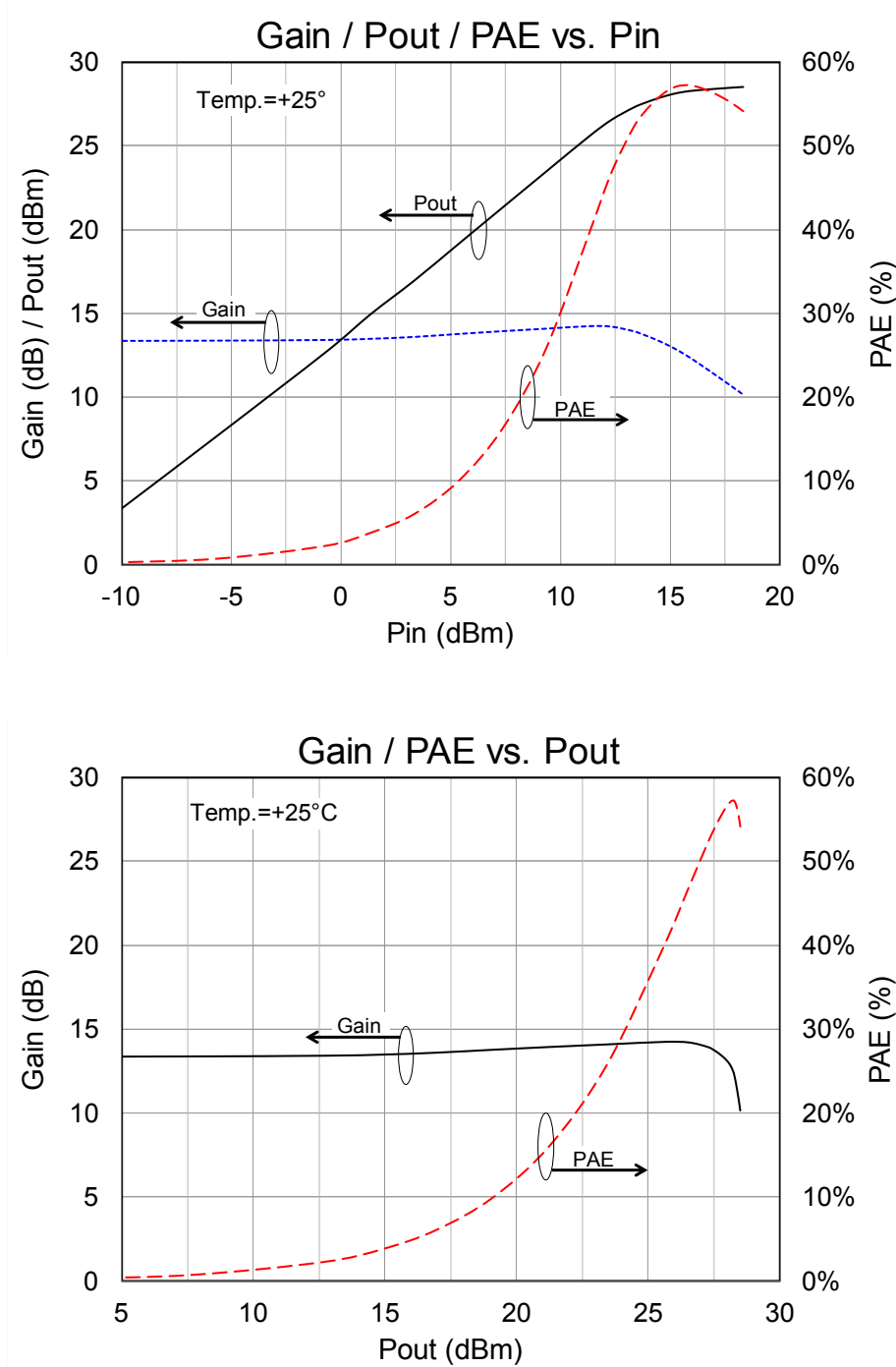

Typical Performance – Various Bias Conditions

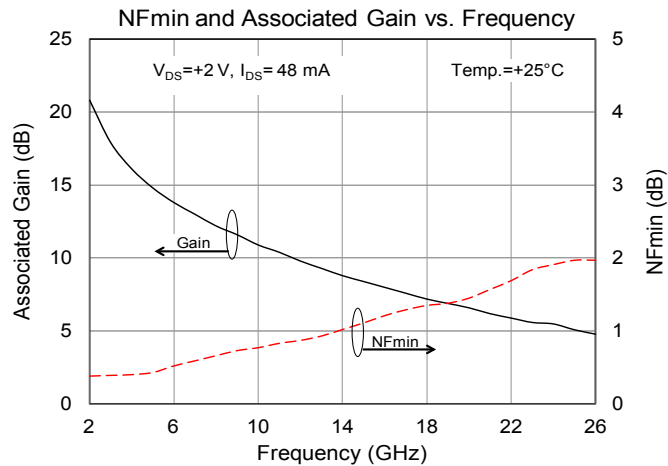
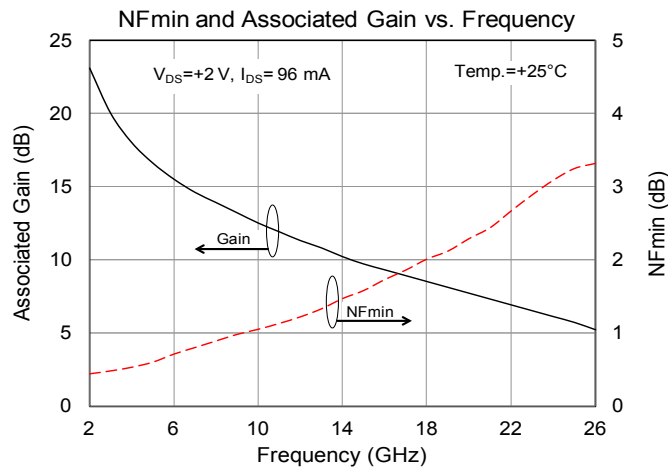
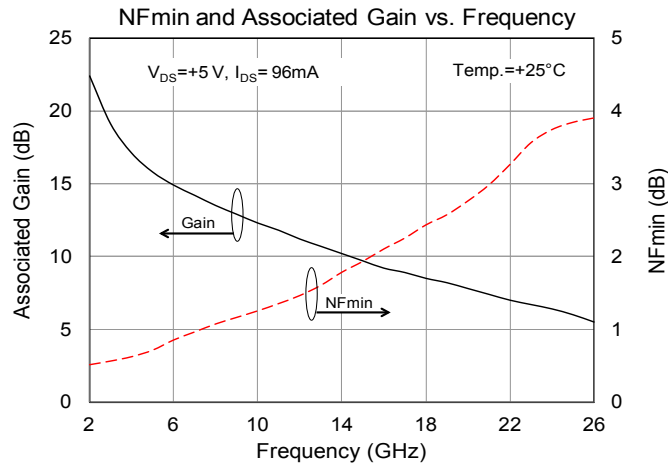

DC Characteristics

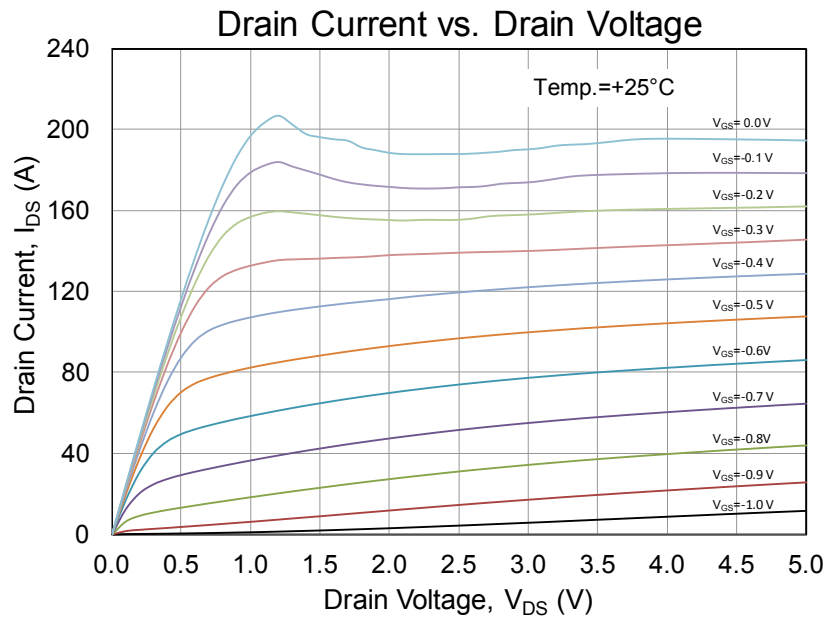

Assembly Notes

Component placement and adhesive attachment assembly notes:

- Vacuum pencils and/or vacuum collets are the preferred method of pick up.
- Air bridges must be avoided during placement.
- The force impact is critical during auto placement.
- Organic attachment (i.e. epoxy) can be used in low-power applications.
- Curing should be done in a convection oven; proper exhaust is a safety concern.

Reflow process assembly notes:

- Recommend Eutectic die attach with AuSn (80/20) solder and limit exposure to temperatures above 300°C to 30 seconds, maximum.
- An alloy station or conveyor furnace with reducing atmosphere should be used.
- Do not use any kind of flux.
- Coefficient of thermal expansion matching is critical for long-term reliability.
- Devices must be stored in a dry nitrogen atmosphere.

Interconnect process assembly notes:

- Either Thermo-compression Wedge Bonding or Thermosonic Ball Bonding can be used to bond onto the die.
- Force, time, and ultrasonics are critical bonding parameters.
- Aluminum wire should not be used.
- Devices with small pad sizes should be bonded with 0.0008-inch wire.

Product Compliance Information

ESD Sensitivity



Caution! ESD-Sensitive Device

GaAs devices are susceptible to damage from Electrostatic Discharge. Proper precautions should be observed during handling, assembly and test.

Not HAST compliant.

RoHs Compliance

This part is compliant with EU 2002/95/EC RoHS directive (Restrictions on the Use of Certain Hazardous Substances in Electrical and Electronic Equipment).

This product also has the following attributes:

- Lead Free
- Halogen Free (Chlorine, Bromine)
- Antimony Free
- TBBP-A (C₁₅H₁₂Br₄O₂) Free
- PFOS Free
- SVHC Free

Contact Information

For the latest specifications, additional product information, worldwide sales and distribution locations, and information about TriQuint:

Web: www.triquint.com
Email: info-sales@triquint.com

Tel: +1.503.615.9000
Fax: +1.503.615.8902

For technical questions and application information:

Email: info-networks@triquint.com

Important Notice

The information contained herein is believed to be reliable. TriQuint makes no warranties regarding the information contained herein. TriQuint assumes no responsibility or liability whatsoever for any of the information contained herein. TriQuint assumes no responsibility or liability whatsoever for the use of the information contained herein. The information contained herein is provided "AS IS, WHERE IS" and with all faults, and the entire risk associated with such information is entirely with the user. All information contained herein is subject to change without notice. Customers should obtain and verify the latest relevant information before placing orders for TriQuint products. The information contained herein or any use of such information does not grant, explicitly or implicitly, to any party any patent rights, licenses, or any other intellectual property rights, whether with regard to such information itself or anything described by such information.

TriQuint products are not warranted or authorized for use as critical components in medical, life-saving, or life-sustaining applications, or other applications where a failure would reasonably be expected to cause severe personal injury or death.