

**800 - 3000 MHz High IP3 Dual pHEMT**

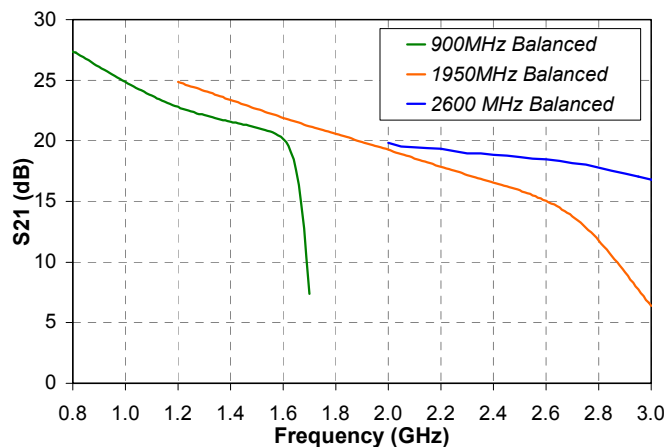

**Measured Performance**

Bias conditions:  $V_d = 4\text{ V}$ ,  $I_d = 100\text{ mA}$ ,  $V_g = -0.2\text{ V}$  Typical

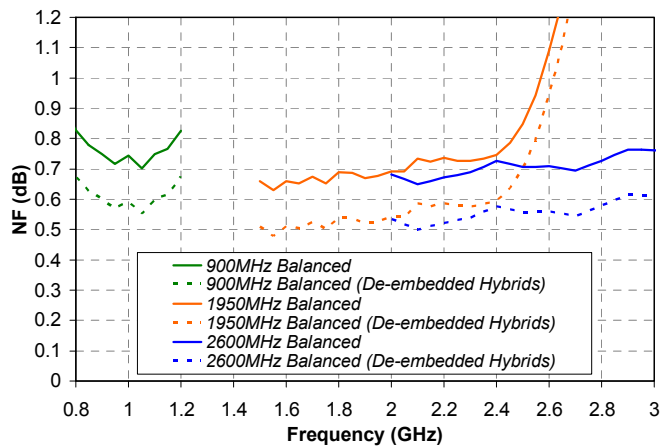

**Key Features and Performance**

- 800 - 3000 MHz Frequency Range
- <0.6 dB Noise Figure
- Gain 24 dB @ 900 MHz, 19 dB @ 1950 MHz, 18 dB @ 2600 MHz
- Bias Conditions: 4 V/100 mA
- Package Dimensions: 2.0 x 2.0 x 0.9 mm

**Primary Applications**

- Wireless Basestation
- WiMAX

**Product Description**

The TriQuint TGA2602-SM is a packaged low noise dual pHEMT discrete device. The TGA2602-SM operates from 800 - 3000 MHz.

The TGA2602-SM in the application circuit typically provides <0.6 dB noise figure with a small signal gain of >19 dB at 1950 MHz, >18 dB at 2600 MHz..

The TGA2602-SM is available in a low-cost, surface mount 6 lead 2 x 2 QFN style package and is ideally suited for wireless basestation and WiMAX applications.

Balanced amplifier evaluation boards are available tuned to 900, 1950, and 2600 MHz upon request.

Lead-free and RoHS compliant.

*Datasheet subject to change without notice.*

**Table I**  
**Absolute Maximum Ratings 1/**

Symbol	Parameter	Value	Notes
V <sup>+</sup>	Positive Supply Voltage	5 V	<u>1/</u> <u>2/</u>
V <sup>-</sup>	Negative Supply Voltage	-1 V to 0.5 V	<u>1/</u>
I <sup>+</sup>	Positive Supply Current (per channel)	100 mA	<u>1/</u> <u>2/</u>
I <sup>-</sup>	Negative Supply Current (per channel)	5 mA	<u>1/</u>
P <sub>IN</sub>	Input Continuous Wave Power	+13 dBm	<u>1/</u> <u>2/</u>
P <sub>D</sub>	Power Dissipation	500 mW	<u>1/</u> <u>2/</u>
T <sub>CH</sub>	Operating Channel Temperature	200 °C	<u>3/</u>
T <sub>M</sub>	Mounting Temperature (10 Seconds)	260 °C	
T <sub>STG</sub>	Storage Temperature	-65 to 150 °C	

- 1/ These ratings represent the maximum operable values for this device
- 2/ Combinations of supply voltage, supply current, input power, and output power shall not exceed P<sub>D</sub> at a package base temperature of 80 °C
- 3/ Junction operating temperature will directly affect the device lifetime (T<sub>M</sub>). For maximum life, it is recommended that junction temperatures be maintained at the lowest possible levels.

**Table II**  
**Recommended Operating Conditions**

Symbol	Parameter	Value
V <sup>+</sup>	Positive Supply Voltage	4 V
V <sup>-</sup>	Negative Supply Voltage	-0.2 V Typical
I <sup>+</sup>	Positive Supply Current (balanced circuit)	100 mA
I <sup>+</sup>	Positive Supply Current (Single Channel)	50 mA

**Table III**  
**RF Characterization Table**  
**TABLE IIIA – 900 MHz Balanced Amplifier**  
**(T<sub>A</sub> = 25 °C, Nominal)**  
**V<sub>d</sub> = 4 V, I<sub>d</sub> = 100 mA**

Parameter	Test Conditions	Typ	Units	Notes
Small Signal Gain	850 – 900 MHz	26	dB	
Input Return Loss	850 – 900 MHz	27	dB	
Output Return Loss	850 – 900 MHz	25	dB	
Noise Figure	850 – 900 MHz	0.75	dB	
Input TOI	850 – 900 MHz	5	dBm	

**TABLE IIIB – 1950 MHz Balanced Amplifier**  
**(T<sub>A</sub> = 25 °C, Nominal)**  
**V<sub>d</sub> = 4 V, I<sub>d</sub> = 100 mA**

Parameter	Test Conditions	Typ	Units	Notes
Small Signal Gain	1950 MHz	19.5	dB	
Input Return Loss	1950 MHz	16	dB	
Output Return Loss	1950 MHz	25	dB	
Noise Figure	1950 MHz	0.65	dB	
Input TOI	1950 MHz	13.5	dBm	

**Table III**  
**RF Characterization Table**

**TABLE IIIC – 2600 MHz Balanced Amplifier**  
 (T<sub>A</sub> = 25 °C, Nominal)  
 V<sub>d</sub> = 4 V, I<sub>d</sub> = 100 mA

Parameter	Test Conditions	Typ	Units	Notes
Small Signal Gain	2600 MHz	18	dB	
Input Return Loss	2600 MHz	27	dB	
Output Return Loss	2600 MHz	27	dB	
Noise Figure	2600 MHz	0.70	dB	
Input TOI	2600 MHz	12	dBm	

**Table IV**  
**Power Dissipation and Thermal Properties**

**THERMAL INFORMATION**

Parameter	Test Conditions	T <sub>CH</sub> (°C)	θ <sub>JC</sub> (°C/W)	T <sub>m</sub> (hrs)
θ <sub>JC</sub> Thermal Resistance (Channel to Backside of Package)	V <sub>D</sub> = 3.5 V I <sub>D</sub> = 100 mA P <sub>DISS</sub> = 0.35 W T <sub>BASE</sub> = 70 °C	97	48.6	2E+10

Note: Thermal transfer is conducted through the bottom of the TGA2602-SM package into the printed circuit board.

**Median Lifetime (T<sub>m</sub>) vs. Channel Temperature**

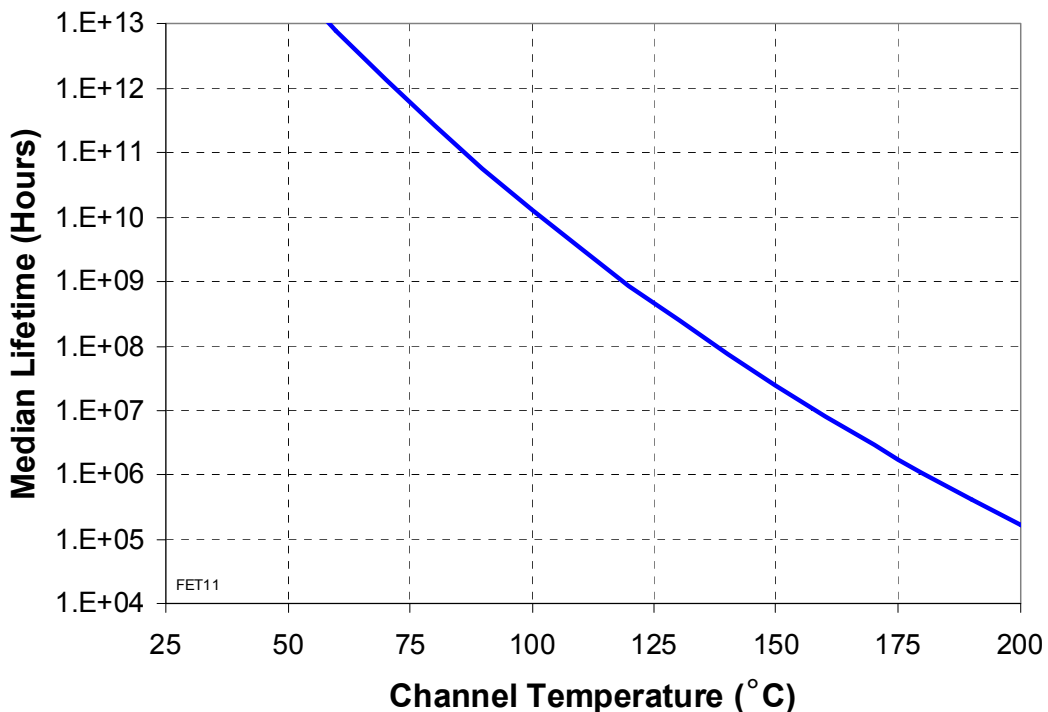

**Measured Data**

**Single Channel 1950 MHz Application Circuit**

Vd = 4 V, Id = 50 mA (Refer to Page 21)

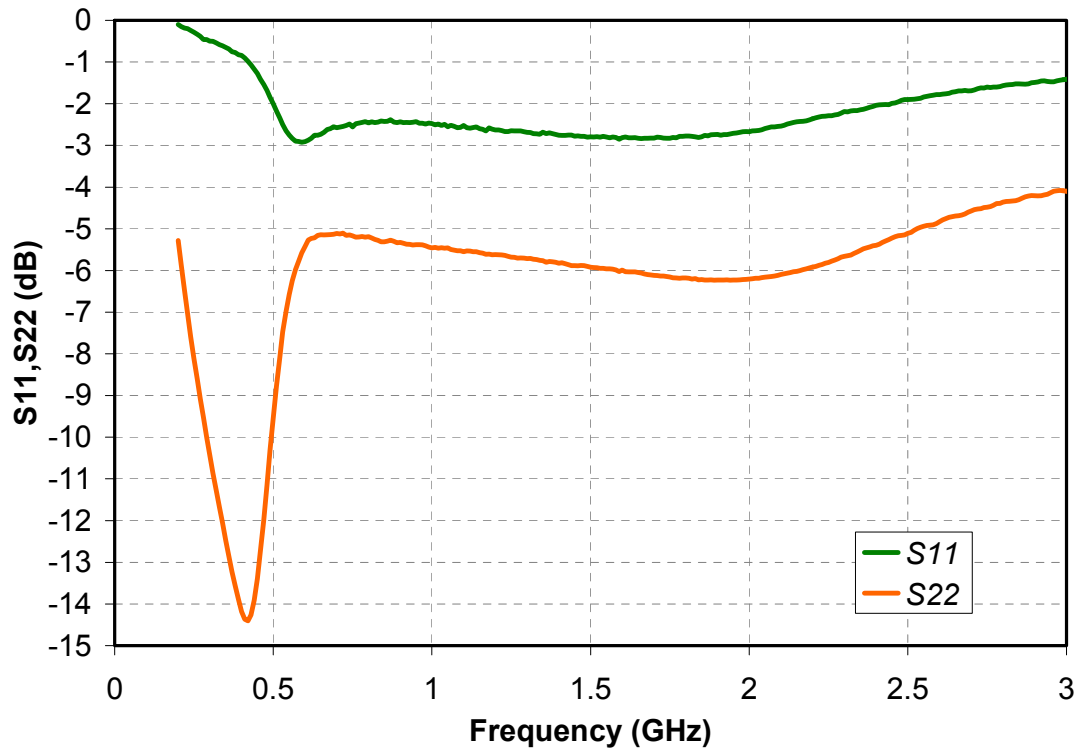
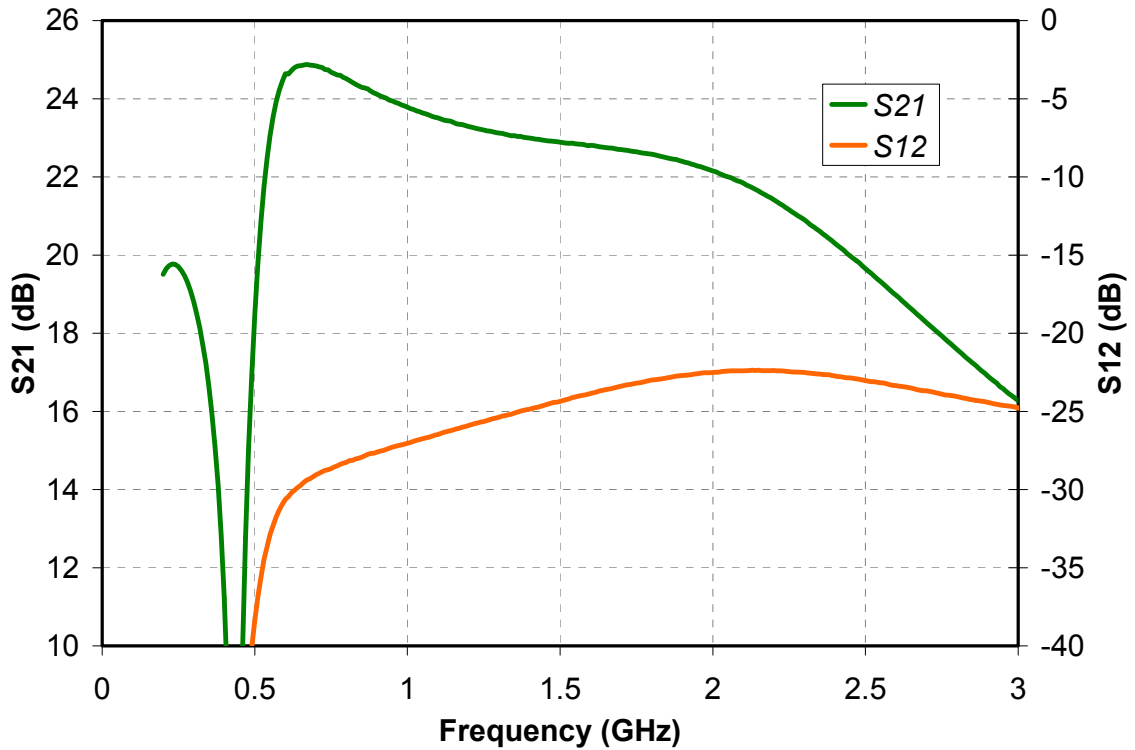

**Measured Data**

**Single Channel 1950 MHz Application Circuit**

**Vd = 4 V, Id = 50 mA (Refer to Page 21)**

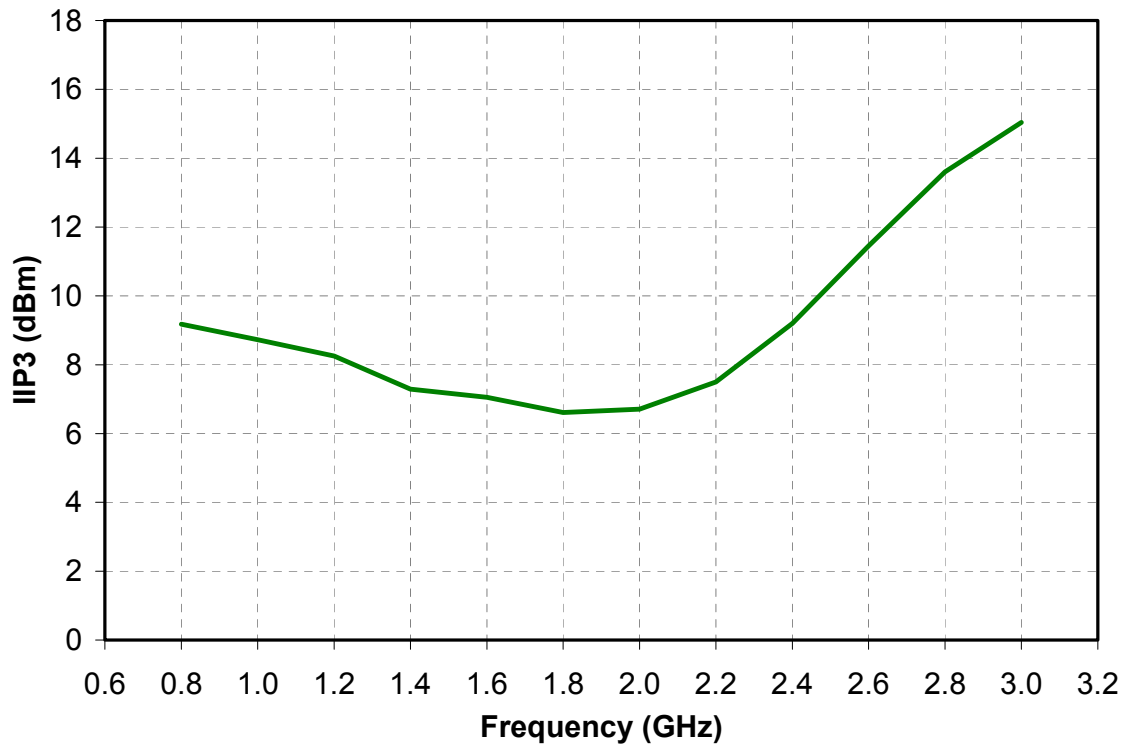
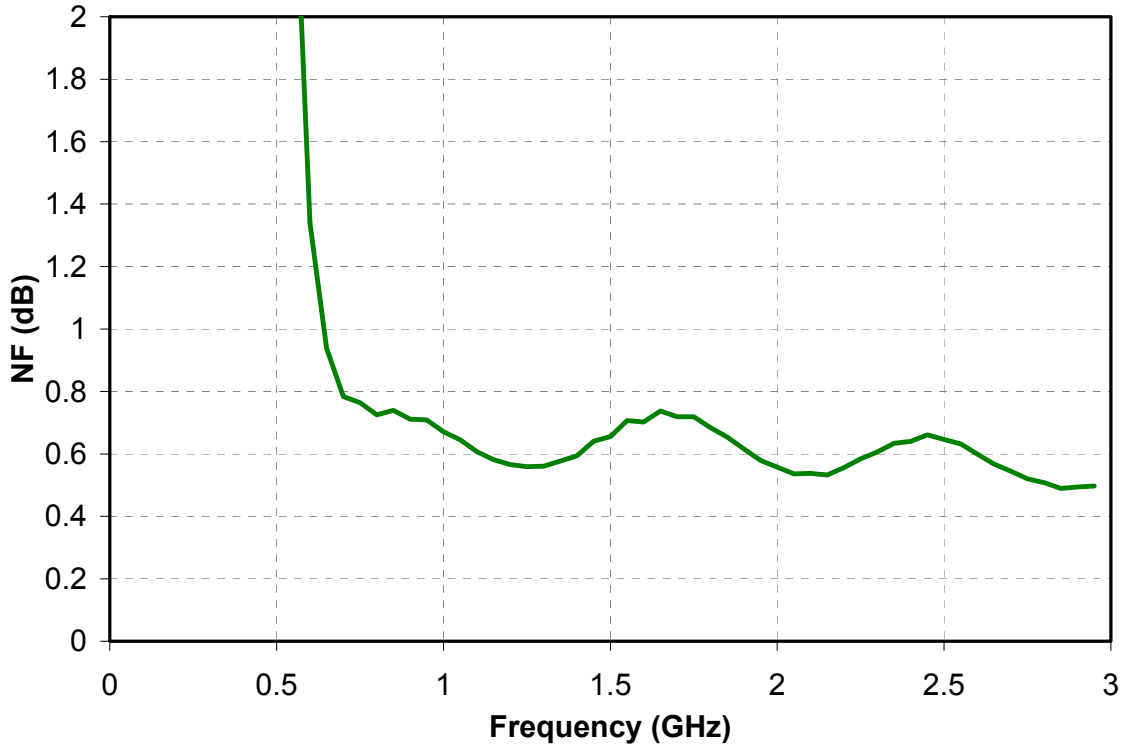

**Measured Data**

**Single Channel 1950 MHz Application Circuit**

Vd = 4 V, Id = 50 mA (Refer to Page 21)

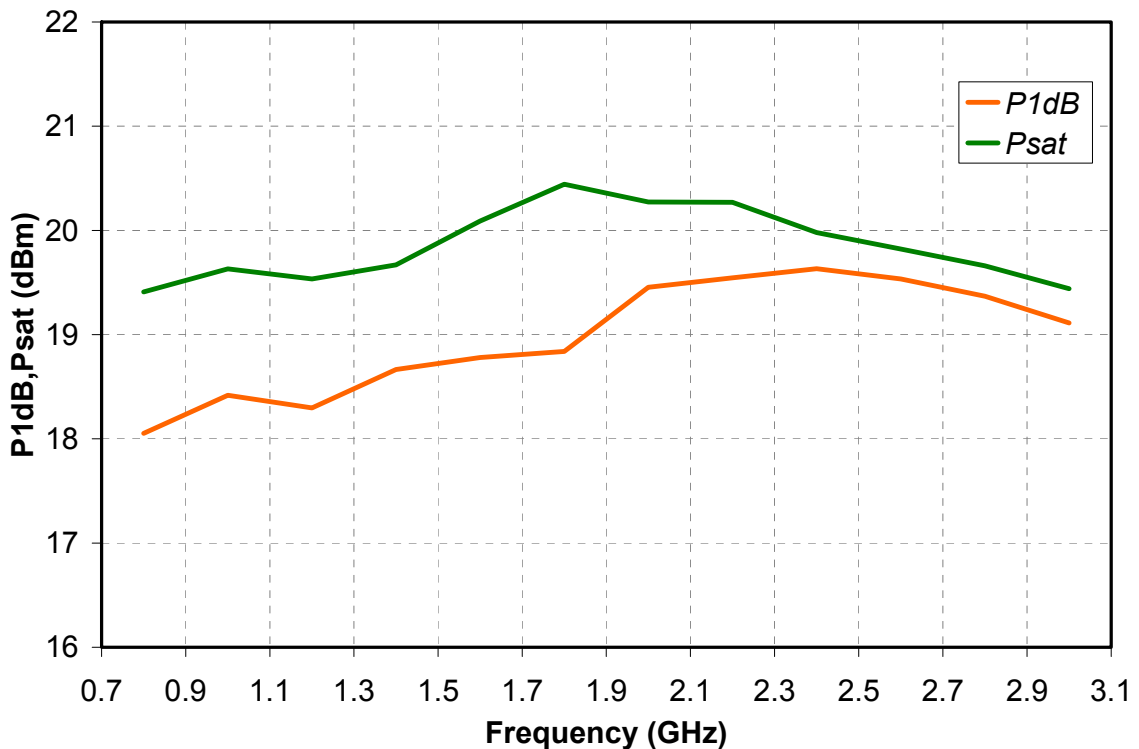
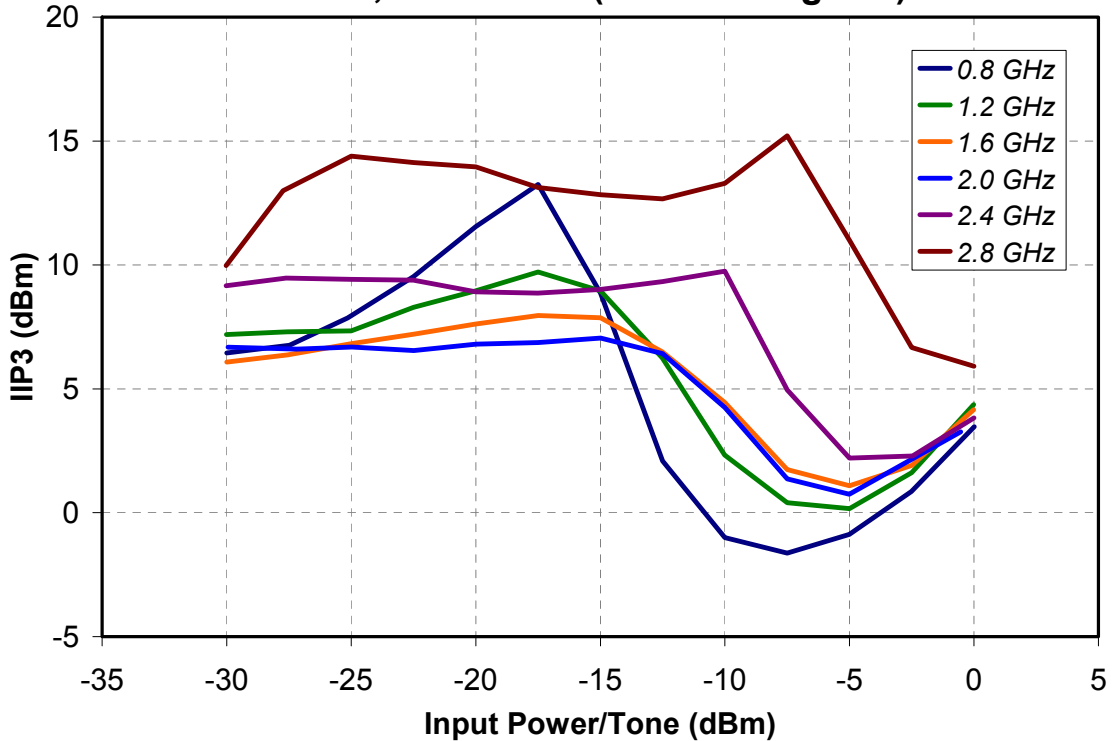



**Measured Data**

**900 MHz Balanced Amplifier Circuit**

**Vd = 4 V, Id = 100 mA (Refer to Page 23)**

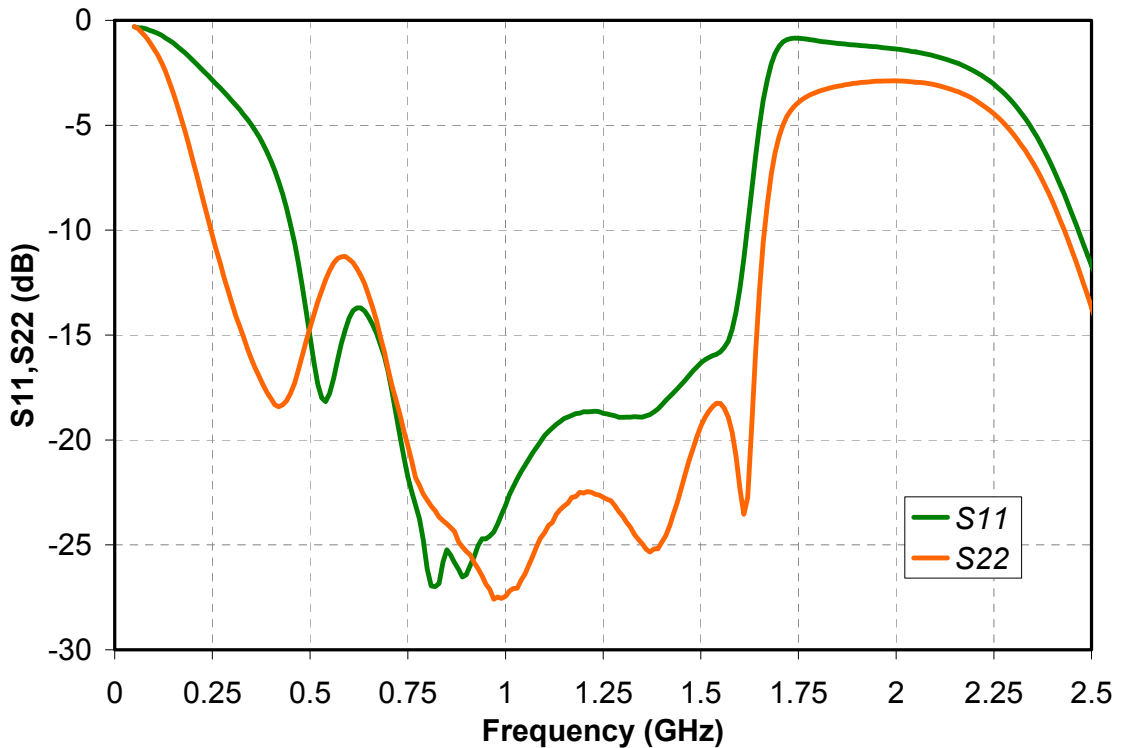
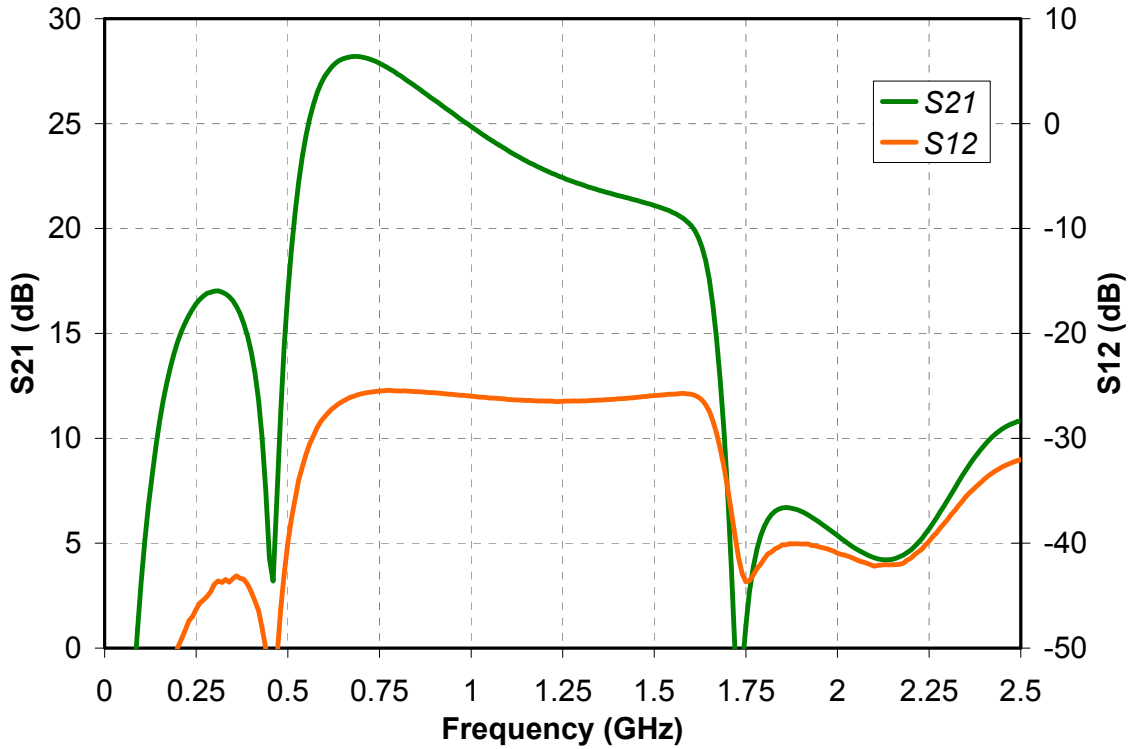

**Measured Data**

**900 MHz Balanced Amplifier Circuit**  
**Vd = 4 V, Id = 100 mA (Refer to Page 23)**

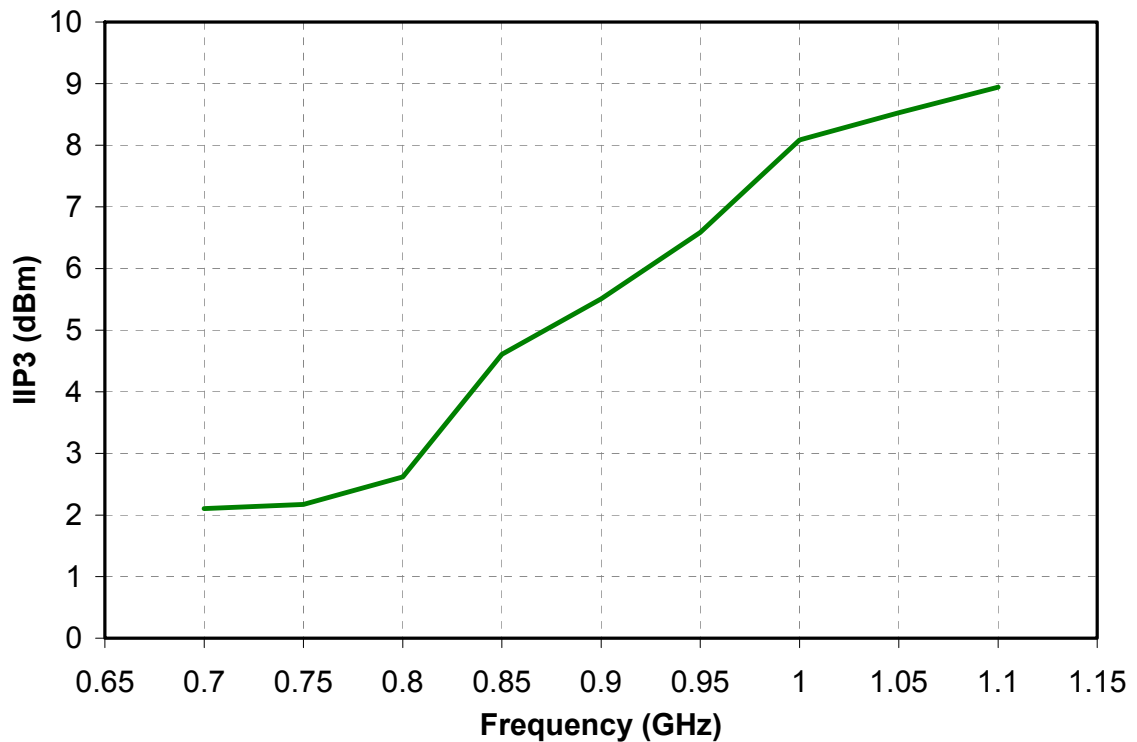
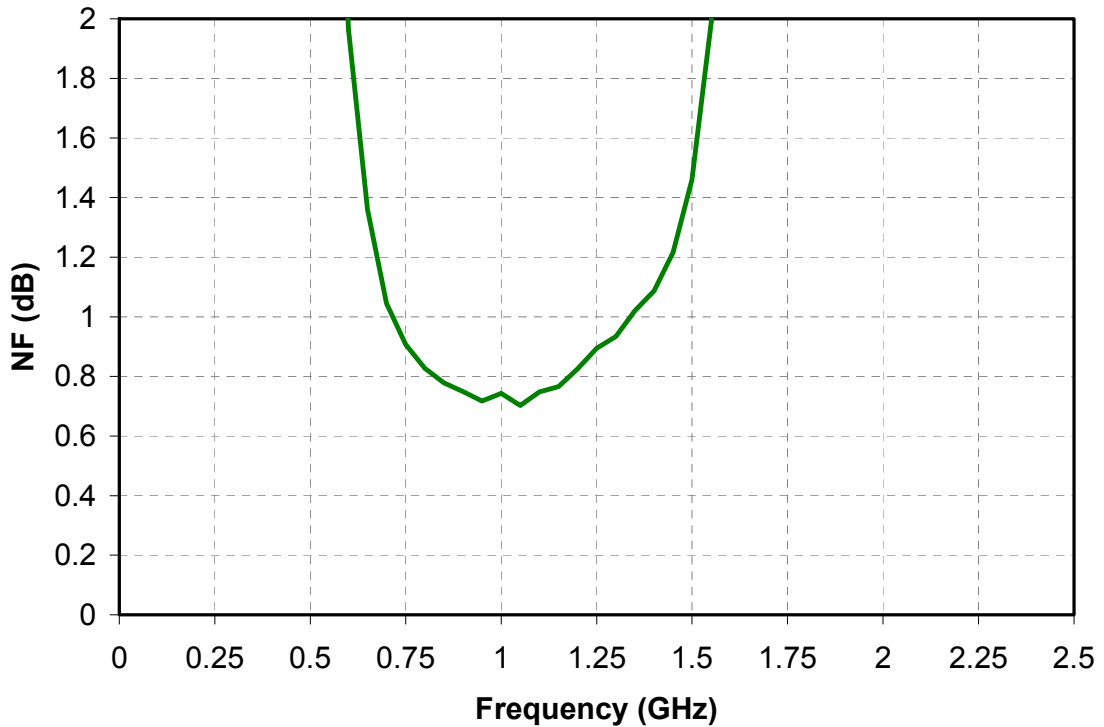

**Measured Data**

**900 MHz Balanced Amplifier Circuit**

Vd = 4 V, Id = 100 mA (Refer to Page 23)

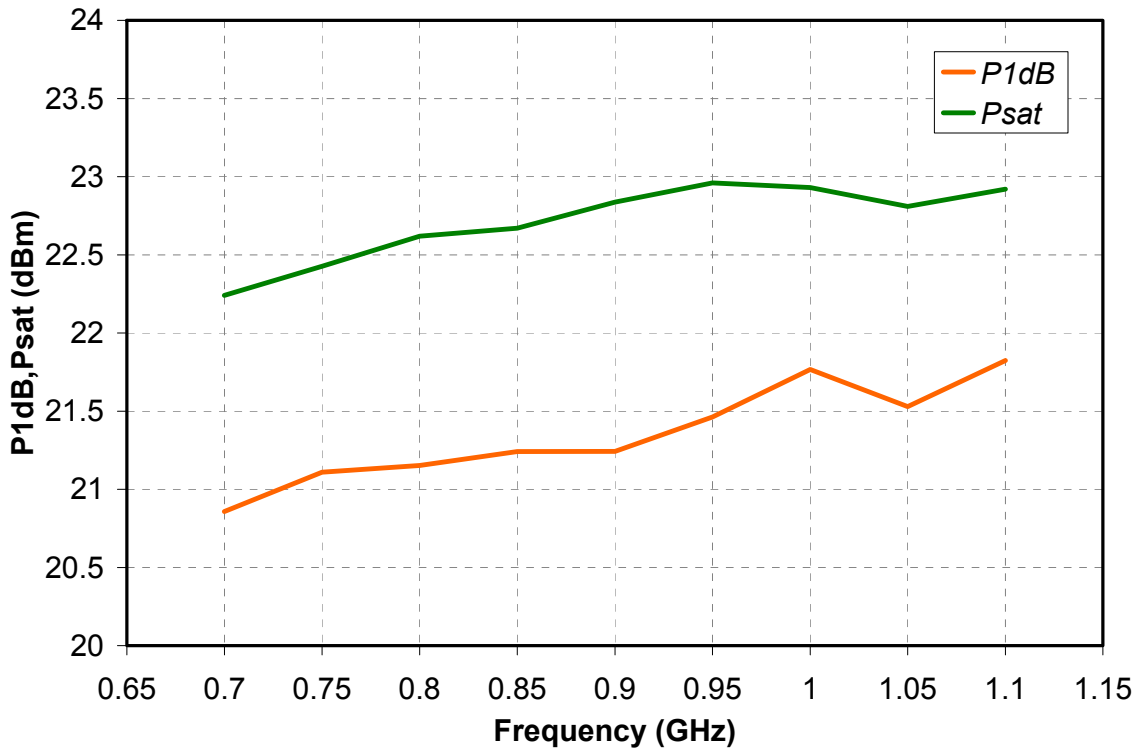
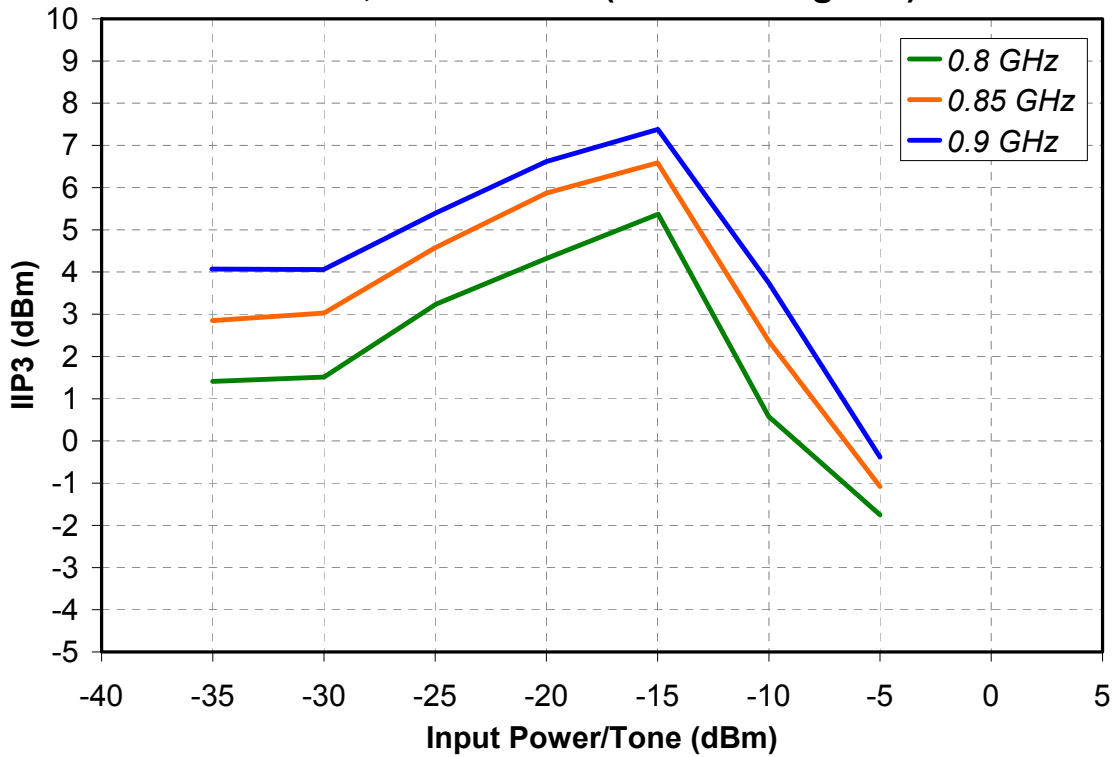

**Measured Data**

**1950 MHz Balanced Amplifier Circuit**

**Vd = 4 V, Id = 100 mA (Refer to Page 24)**

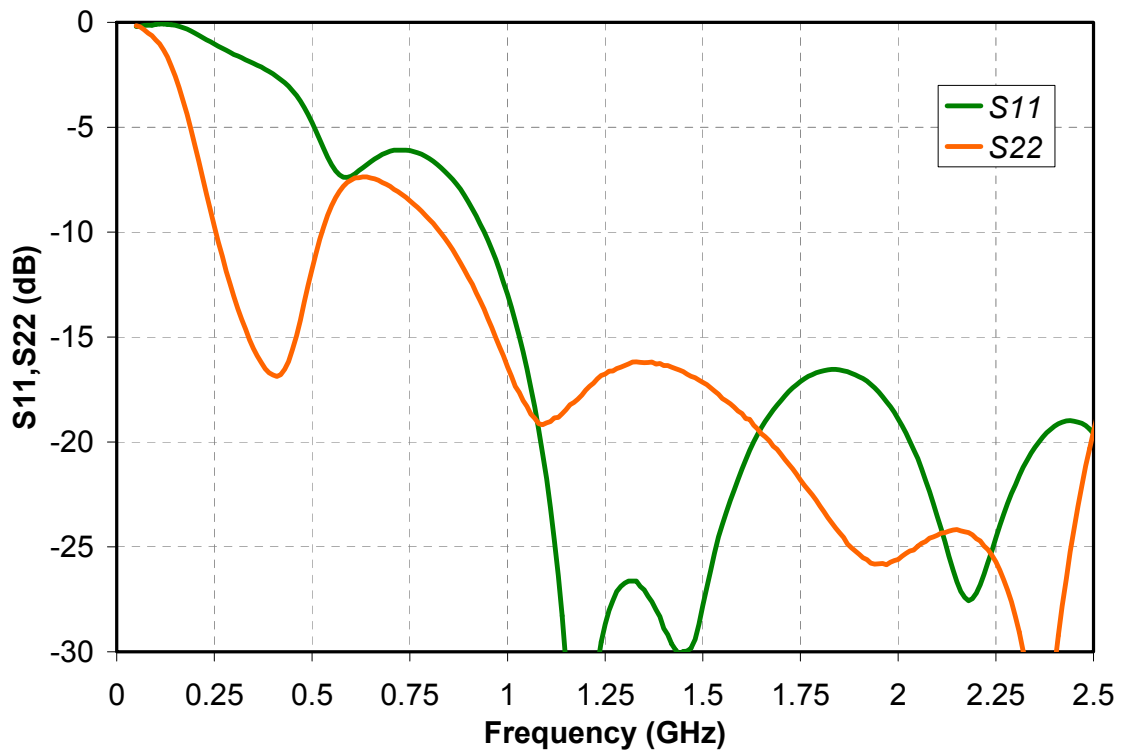
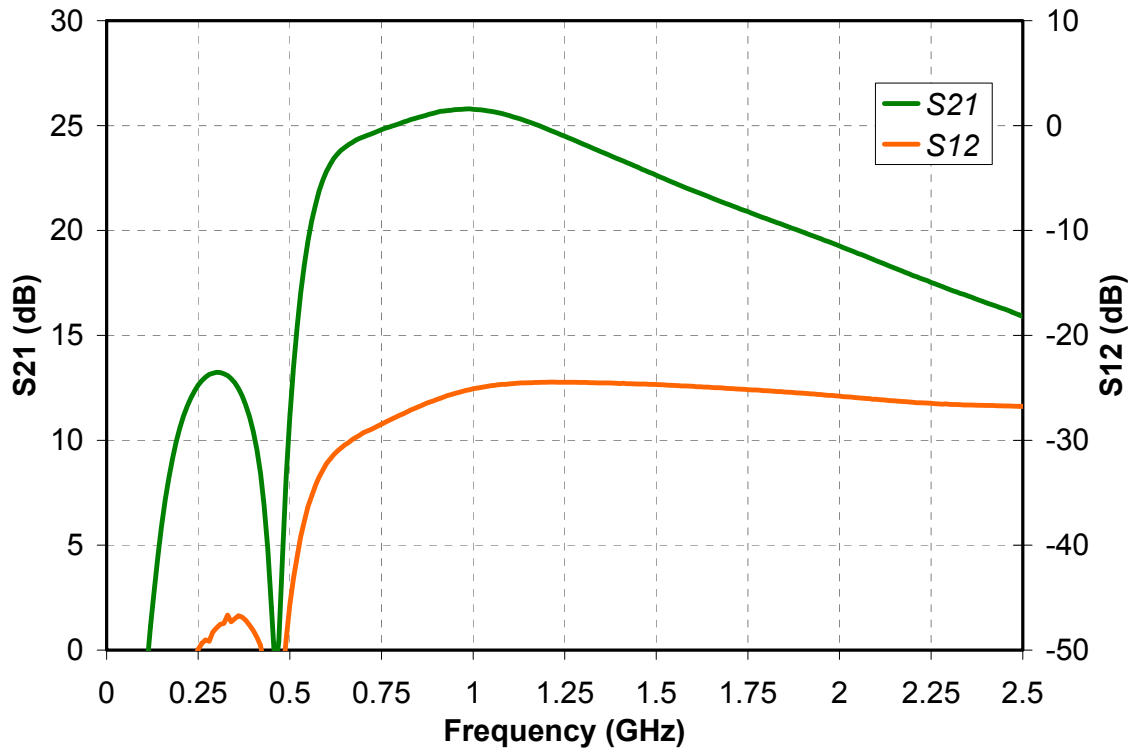

**Measured Data**

**1950 MHz Balanced Amplifier Circuit**  
**Vd = 4 V, Id = 100 mA (Refer to Page 24)**

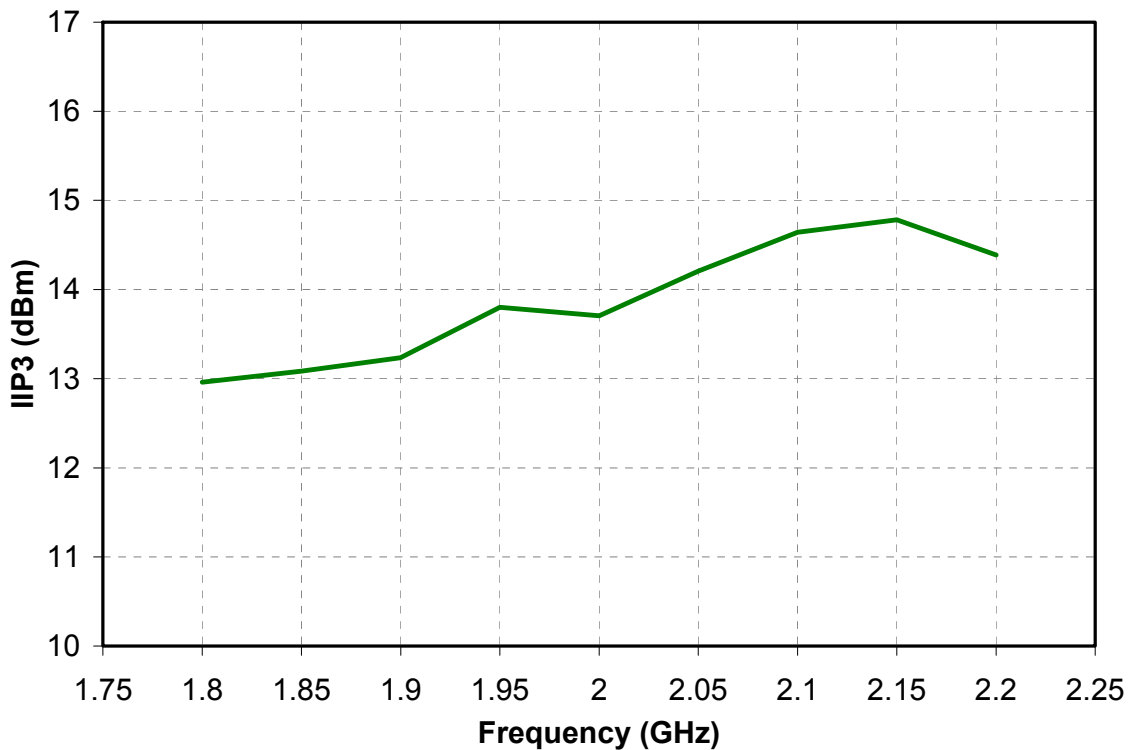
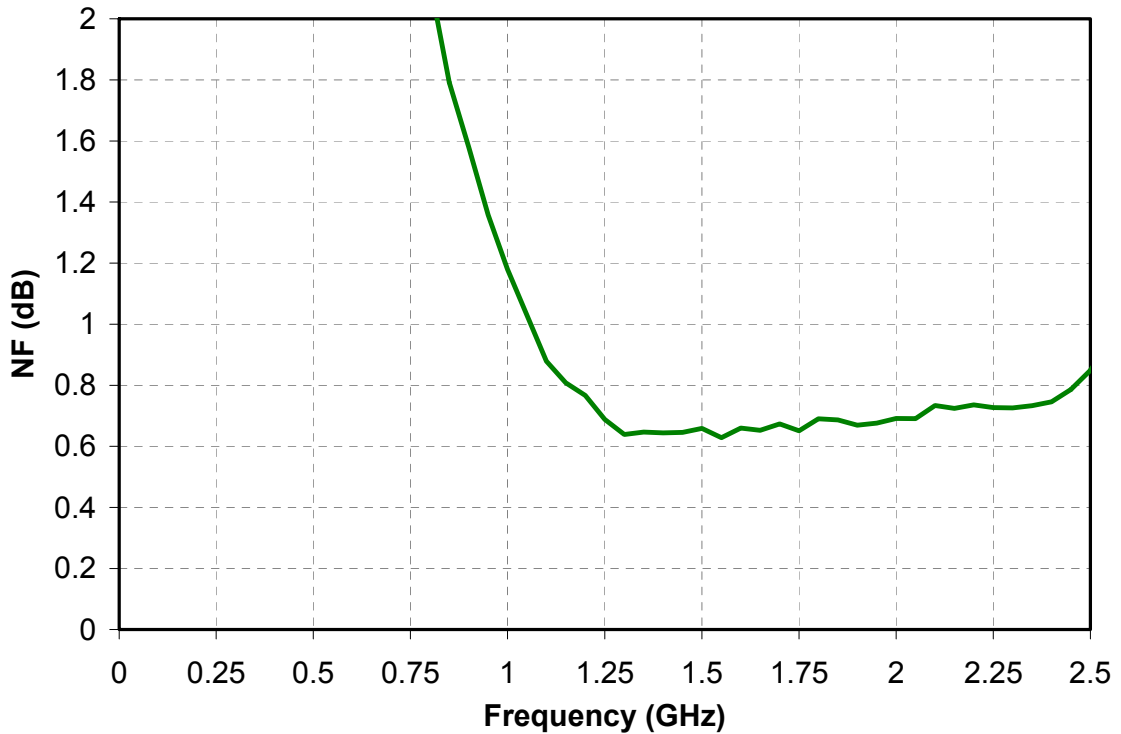

**Measured Data**

**1950 MHz Balanced Amplifier Circuit**

Vd = 4 V, Id = 100 mA (Refer to Page 24)

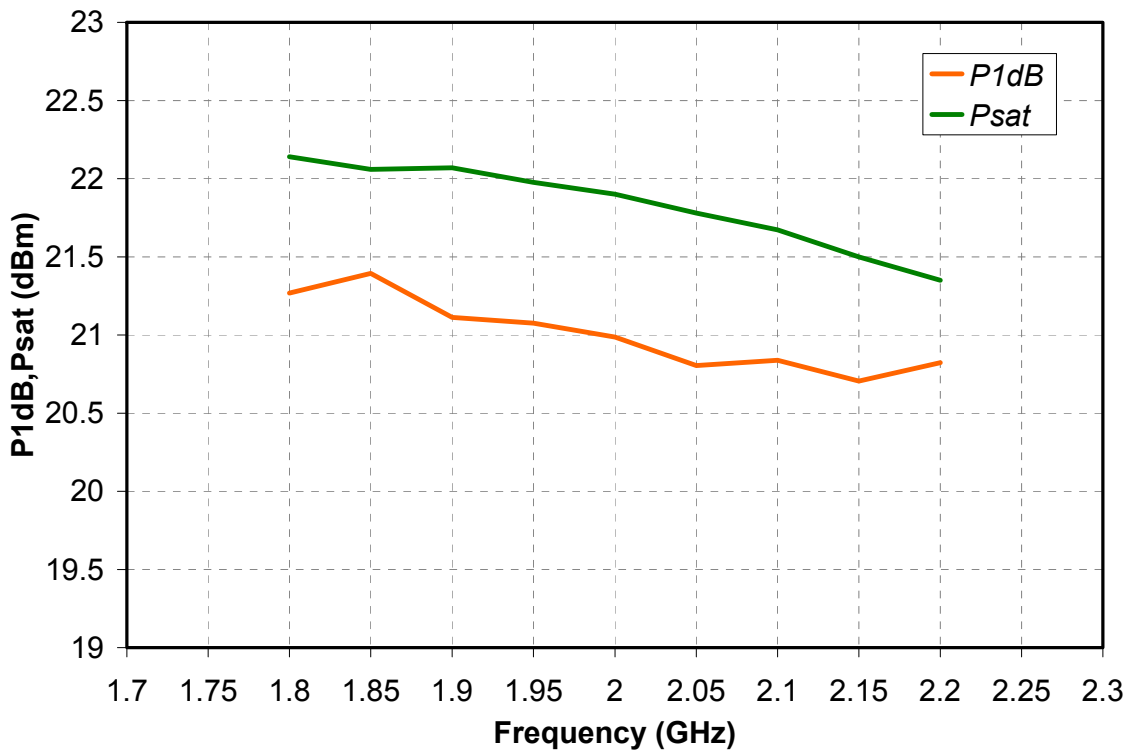
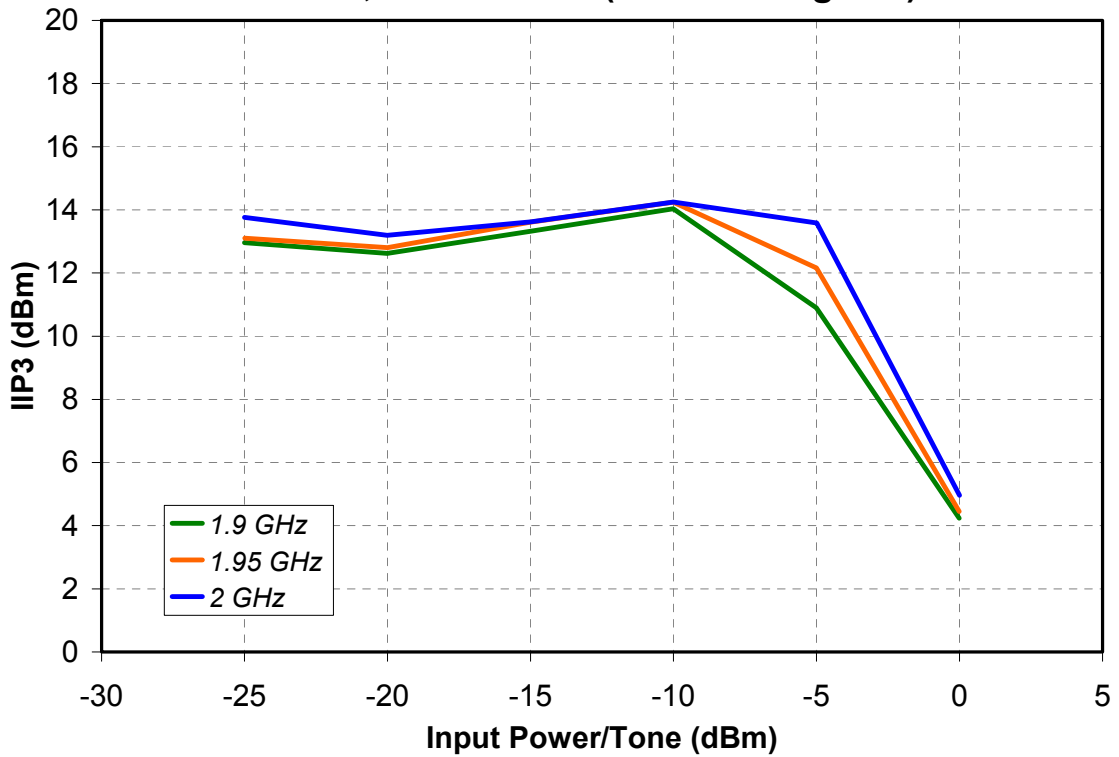

**Measured Data**

**2600 MHz Balanced Amplifier Circuit**

**Vd = 4 V, Id = 100 mA ( Refer to page 26)**

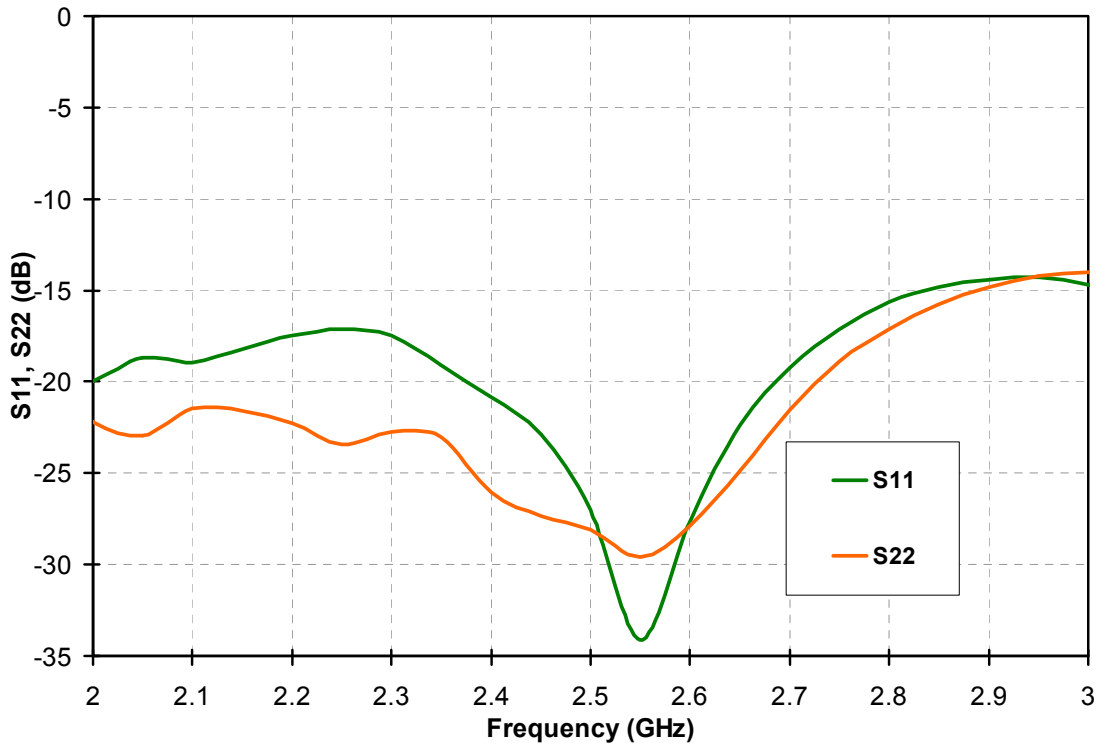
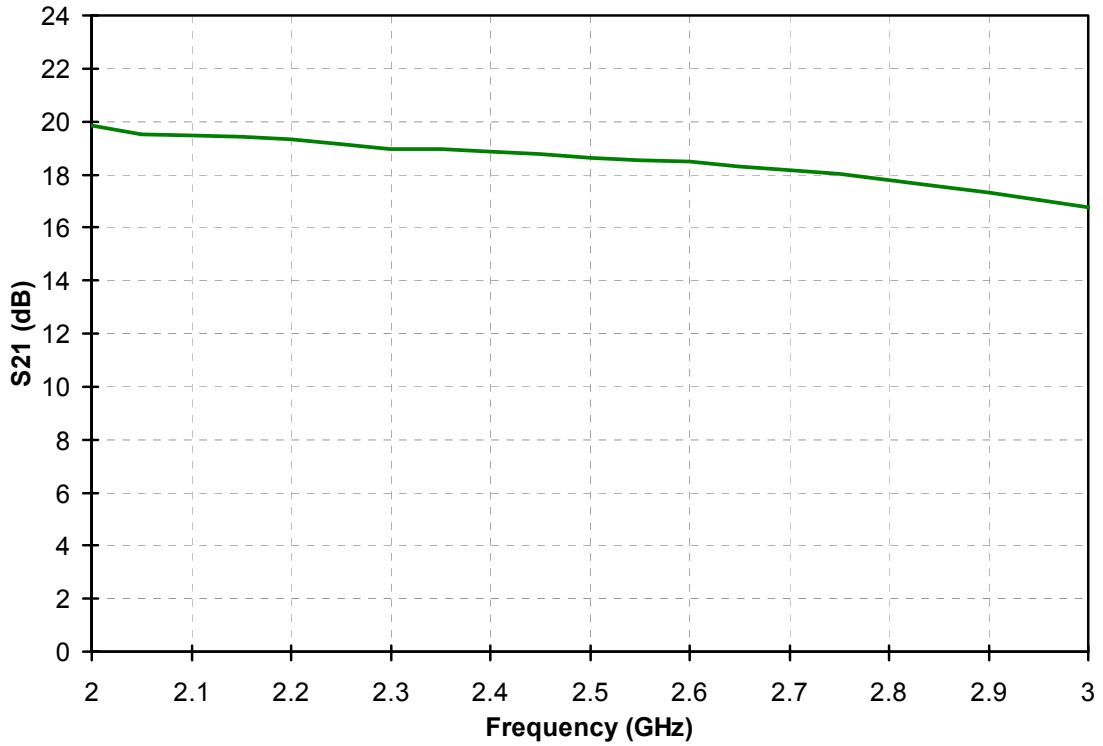

**Measured Data**

**2600 MHz Balanced Amplifier Circuit**

**Vd = 4 V, Id = 100 mA ( Refer to page 26)**

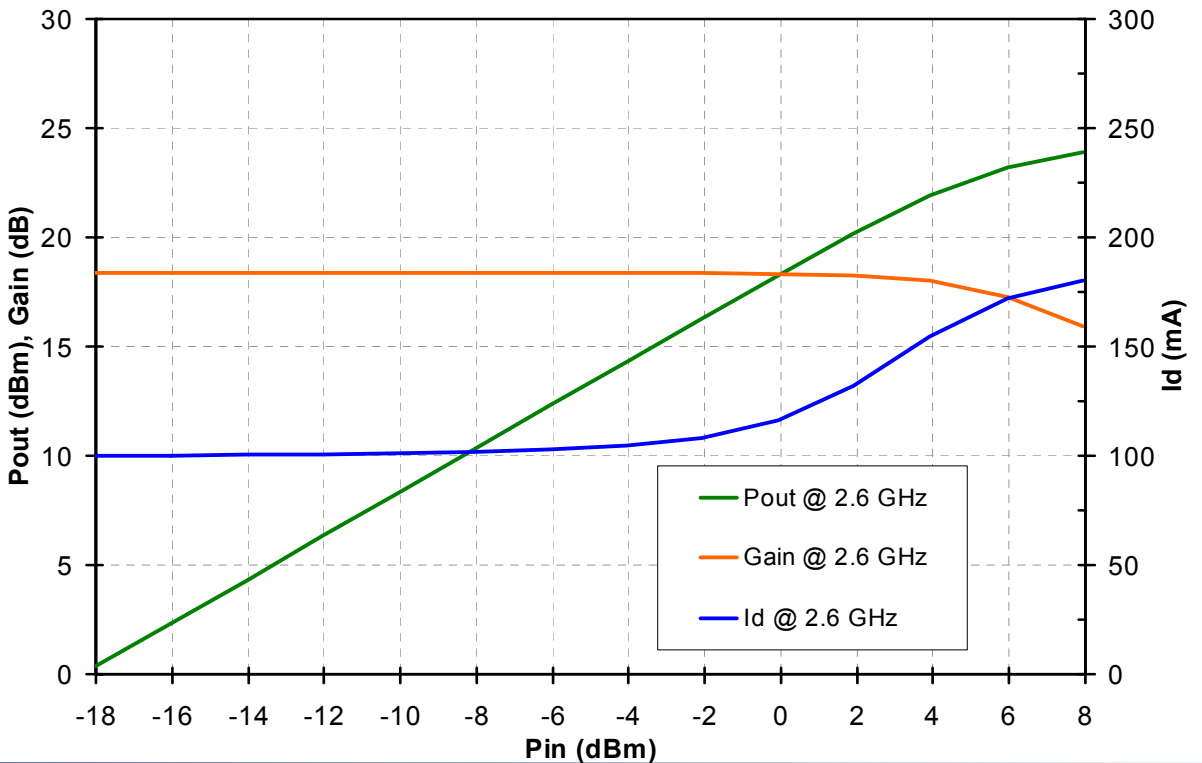
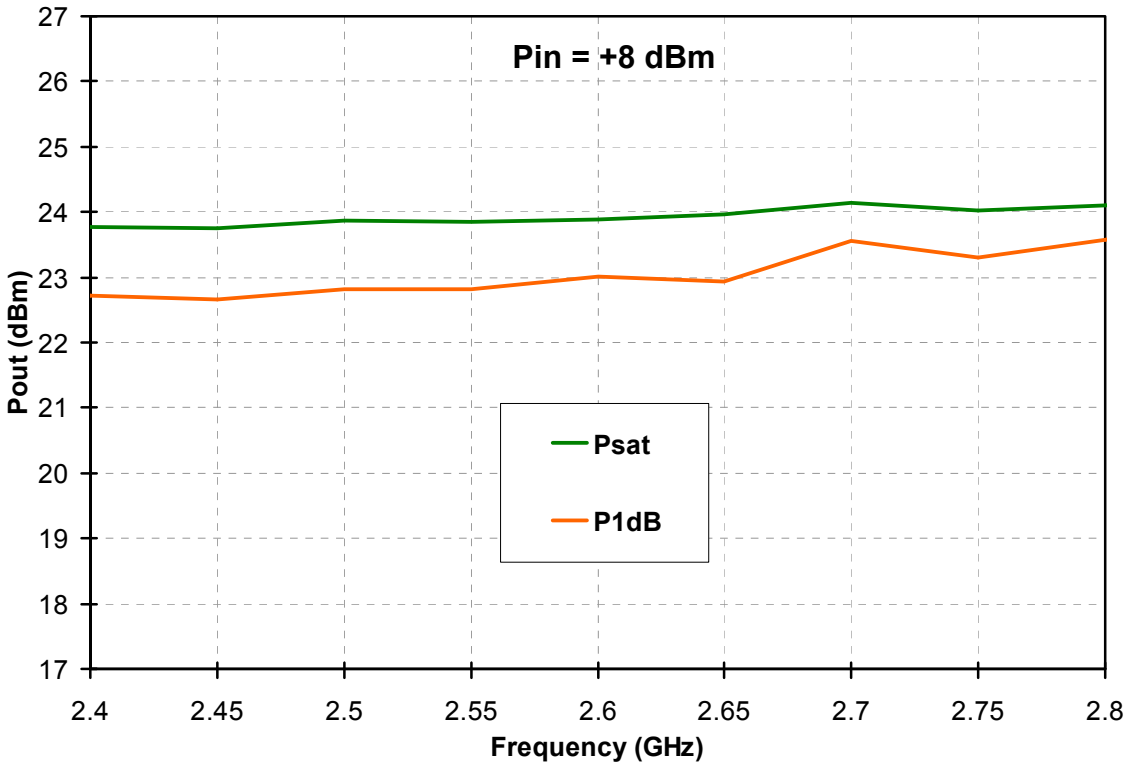



**Measured Data**

**2600 MHz Balanced Amplifier Circuit**

**Vd = 4 V, Id = 100 mA ( Refer to page 26)**

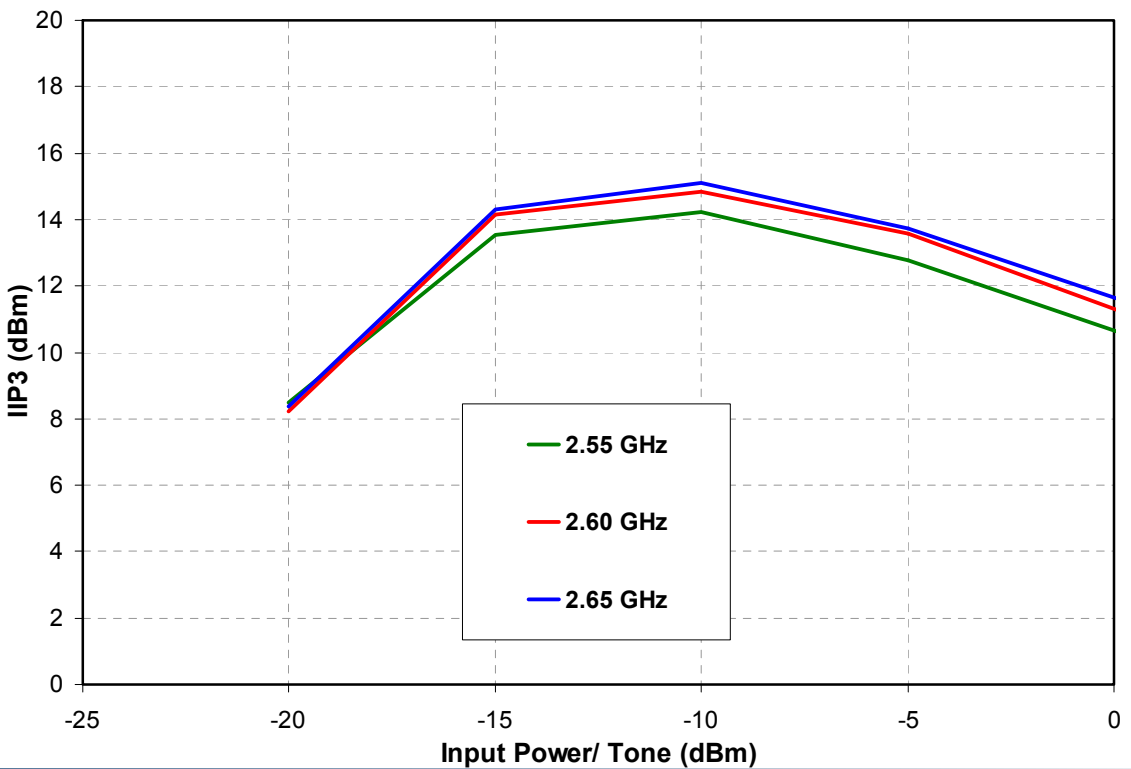
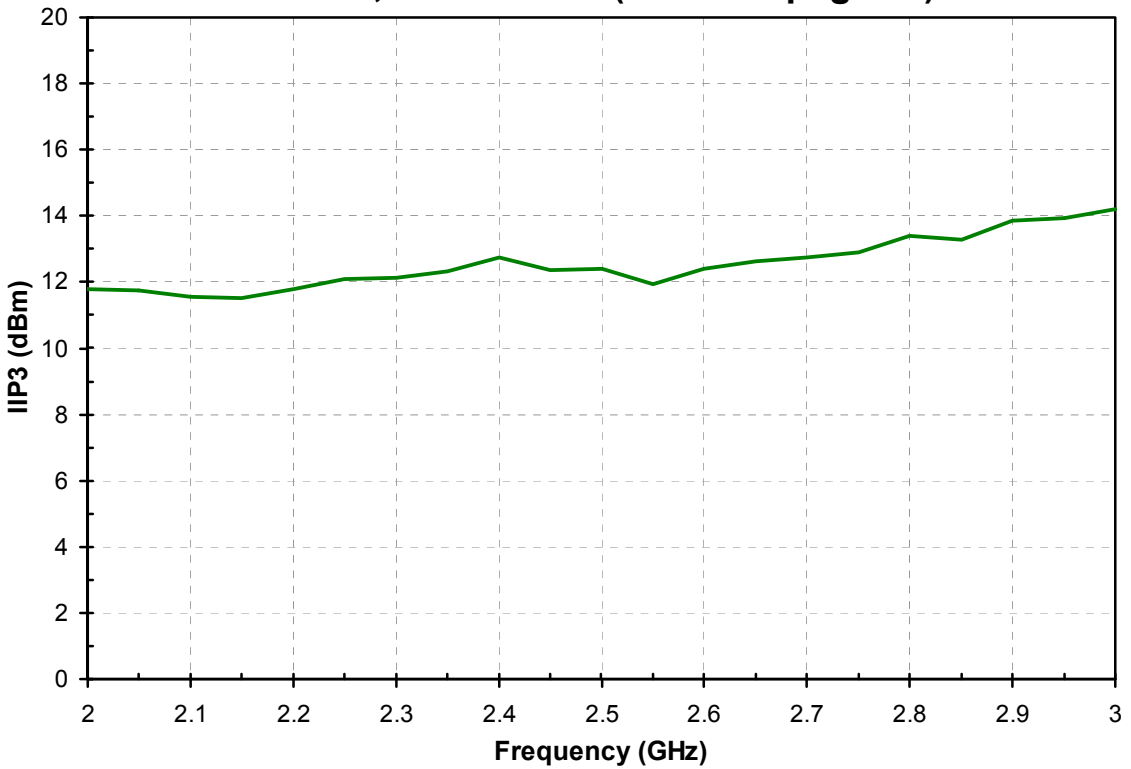

**Measured Data**

**2600 MHz Balanced Amplifier Circuit**

**Vd = 4 V, Id = 100 mA ( Refer to page 26)**

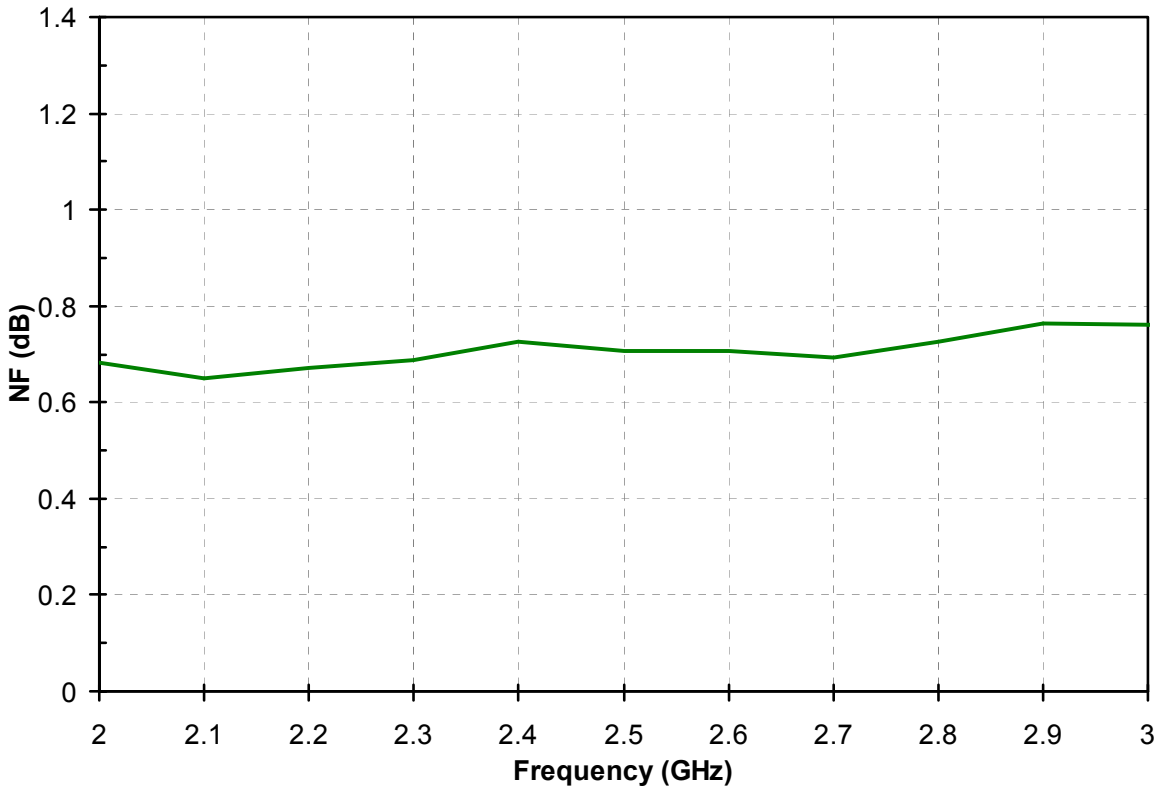

**Package S-Parameters Single Channel**
**Vd = 4 V, Id = 50 mA**

Freq	S11mag	S11ang	S21Mag	S21Ang	S12Mag	S12Ang	S22Mag	S22Ang
0.5	0.954	-37.26	16.273	152.65	0.024	67.71	0.315	-42.03
1	0.873	-75.01	14.862	126.55	0.045	46.61	0.32	-83.94
1.5	0.812	-108.98	12.833	104.16	0.059	29.33	0.325	-118.8
2	0.764	-140.5	10.831	84.13	0.067	14.77	0.315	-148.91
2.5	0.72	-166.36	8.942	67.36	0.07	3.91	0.296	-174.63
3	0.728	172.09	7.598	52.21	0.072	-8.36	0.296	159.51
3.5	0.739	154.15	6.516	38.58	0.075	-17.56	0.309	139.75
4	0.748	139.42	5.792	25.59	0.08	-24.69	0.346	128.19
4.5	0.731	125.28	5.438	12.76	0.08	-35.53	0.368	115.45
5	0.704	107.03	4.934	-1.21	0.084	-47.45	0.414	101.4
5.5	0.633	88.38	4.256	-18.11	0.079	-60.93	0.508	92
6	0.52	70.65	3.445	-33.7	0.066	-79.86	0.589	80.89
6.5	0.437	49.7	2.817	-44.76	0.058	-76.88	0.615	66.94
7	0.343	25.91	2.198	-54.88	0.047	-82.13	0.632	56.78
7.5	0.371	16.85	1.928	-59.39	0.057	-70.57	0.616	47.97
8	0.36	4.5	1.634	-64.52	0.059	-82.19	0.638	42.59
8.5	0.55	10.56	1.669	-69.29	0.048	-82.8	0.659	35.1
9	0.632	0.45	1.505	-78.54	0.07	-90.11	0.649	28.92
9.5	0.716	-5.53	1.328	-86.54	0.078	-107.09	0.666	20.26
10	0.751	-8.7	1.21	-88.2	0.077	-124.58	0.627	12.76
10.5	0.815	-11.2	1.174	-95.35	0.058	-146.77	0.648	6.67
11	0.869	-15.32	1.103	-104.6	0.049	-137.66	0.657	0.35
11.5	0.709	-13.72	1.127	-98.86	0.056	-134.9	0.673	-5.53
12	0.867	-11.72	1.188	-118.37	0.057	-144.64	0.692	-13.25

**Single Channel 1950 MHz Circuit Schematic**

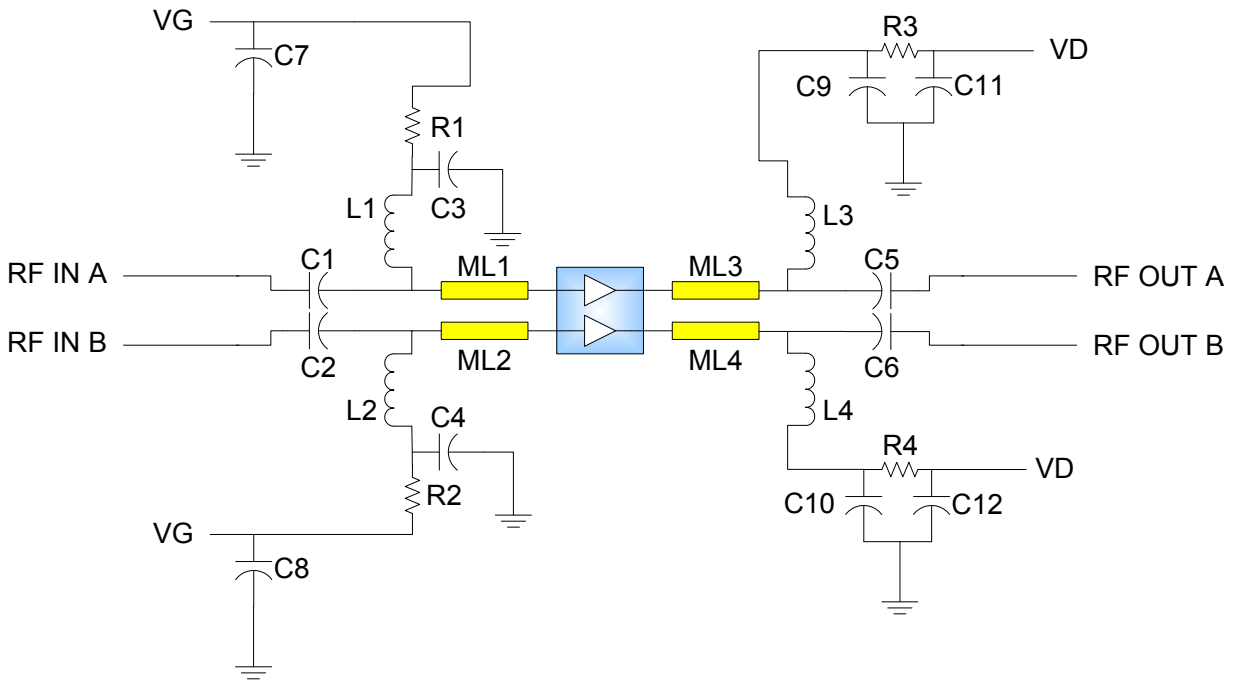

Designator	Component
C1,C2	22 pF Capacitor
C3,C4	4.7 pF Capacitor
C5,C6,C9,C10	10 pF Capacitor
C7,C8,C11,C12	1 uF Capacitor
L1,L2	22 nH Inductor
L3,L4	47 nH Inductor
R1,R2	2.2 kOhm Resistor
R3,R4	10 Ohm Resistor

Designator	Impedance	Electrical Length @ 2GHz
ML1,ML2	117 Ohm	14 degrees
ML3,ML4	82 Ohm	3 degrees

**Single Channel 1950 MHz Application Layout**

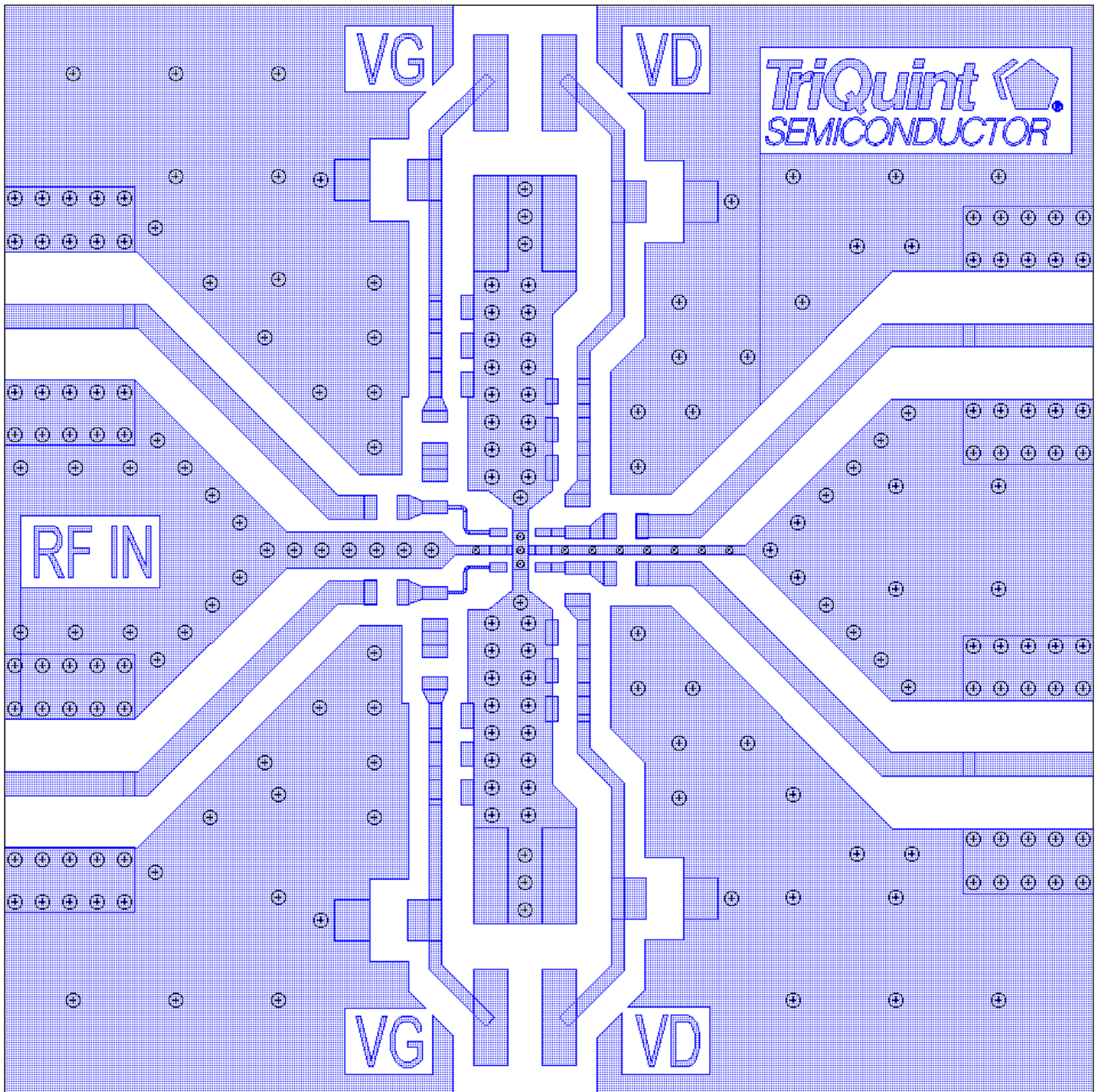

## Balanced Amplifier 900 MHz and 1500MHz Circuit Schematic

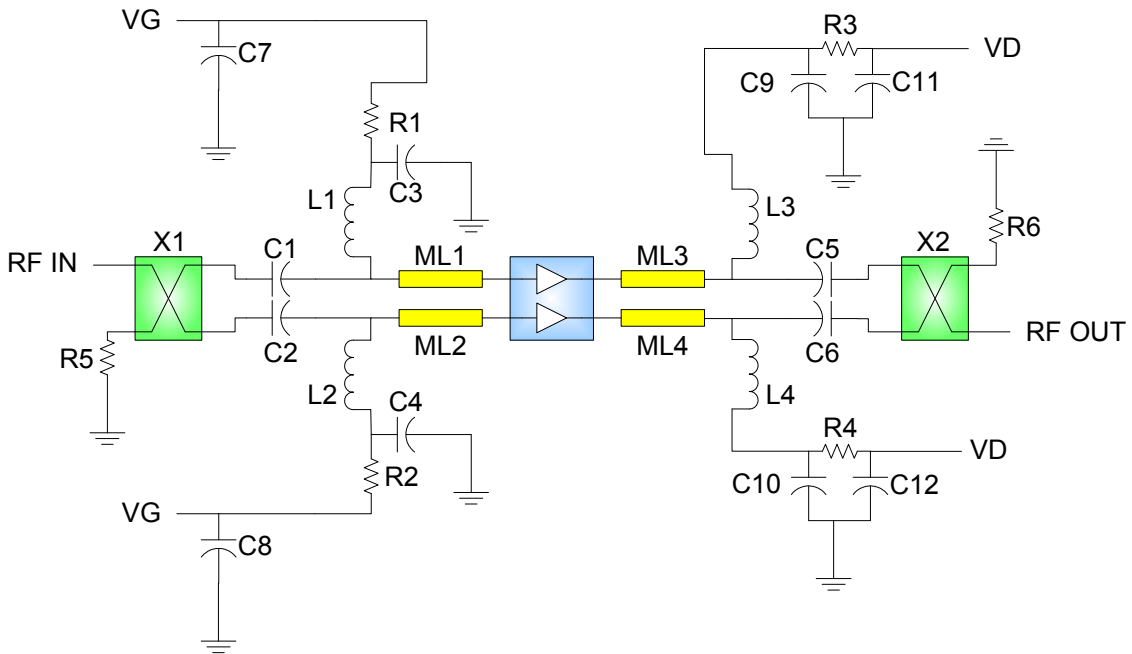

Designator	Component
C1,C2	22 pF Capacitor
C3,C4	4.7 pF Capacitor
C5,C6,C9,C10	10 pF Capacitor
C7,C8,C11,C12	1 uF Capacitor
L1,L2	22 nH Inductor
L3,L4	47 nH Inductor
R1,R2	2.2 kOhm Resistor
R3,R4	10 Ohm Resistor
R5,R6	50 Ohm Resistor

### 900MHz Circuit

Designator	Component	Part Number
X1,X2	Anaren Hybrid	XC0900A-03

Designator	Impedance	Electrical Length @ 900MHz
ML1,ML2	96 Ohm	35 degrees
ML3,ML4	74 Ohm	8 degrees

### 1950MHz Circuit

Designator	Component	Part Number
X1,X2	Anaren Hybrid	XC1900A-03

Designator	Impedance	Electrical Length @ 2GHz
ML1,ML2	96 Ohm	30 degrees
ML3,ML4	74 Ohm	17 degrees

**900 MHz Balanced Amplifier Layout**

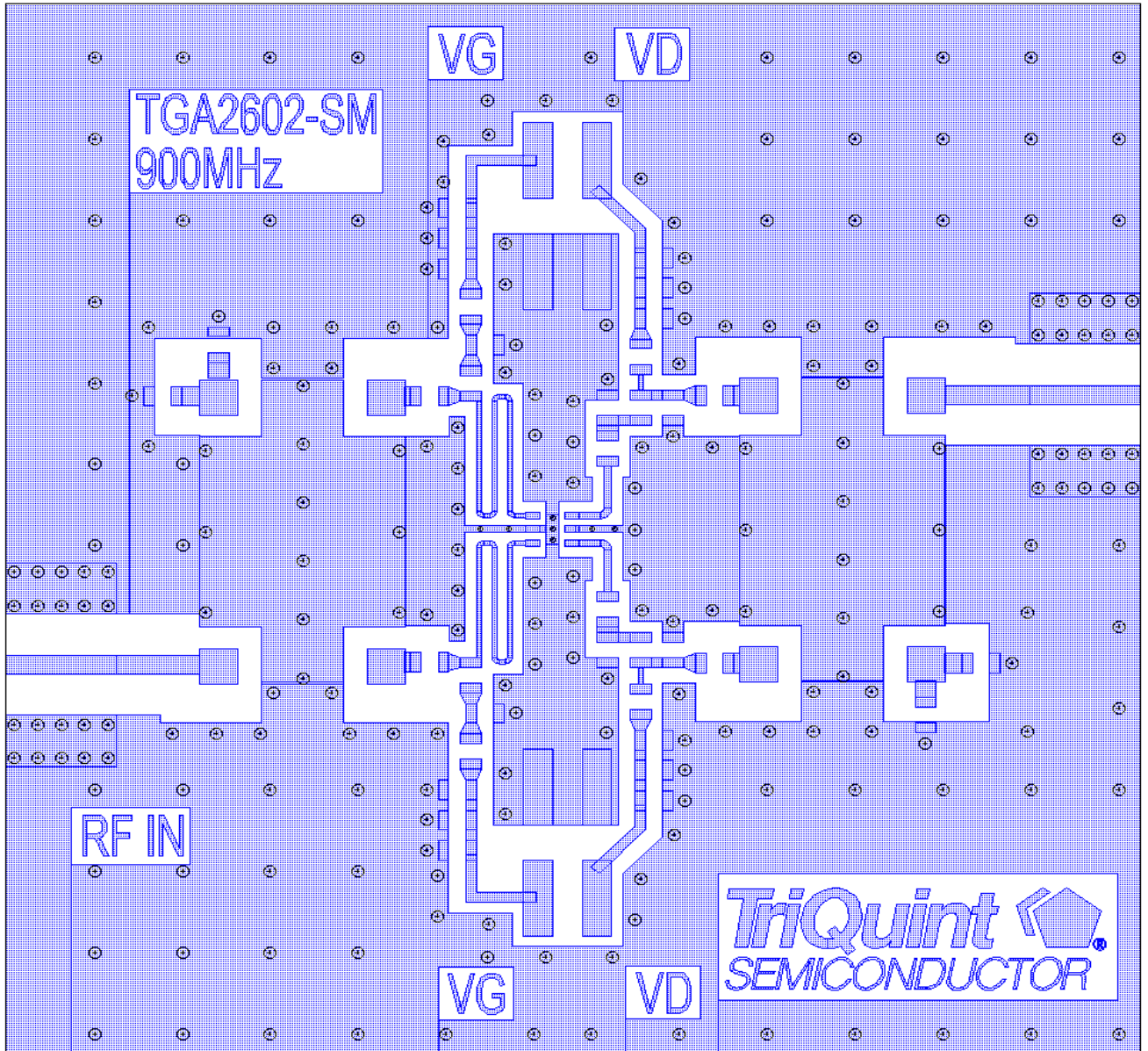

**1950 MHz Balanced Amplifier Layout**

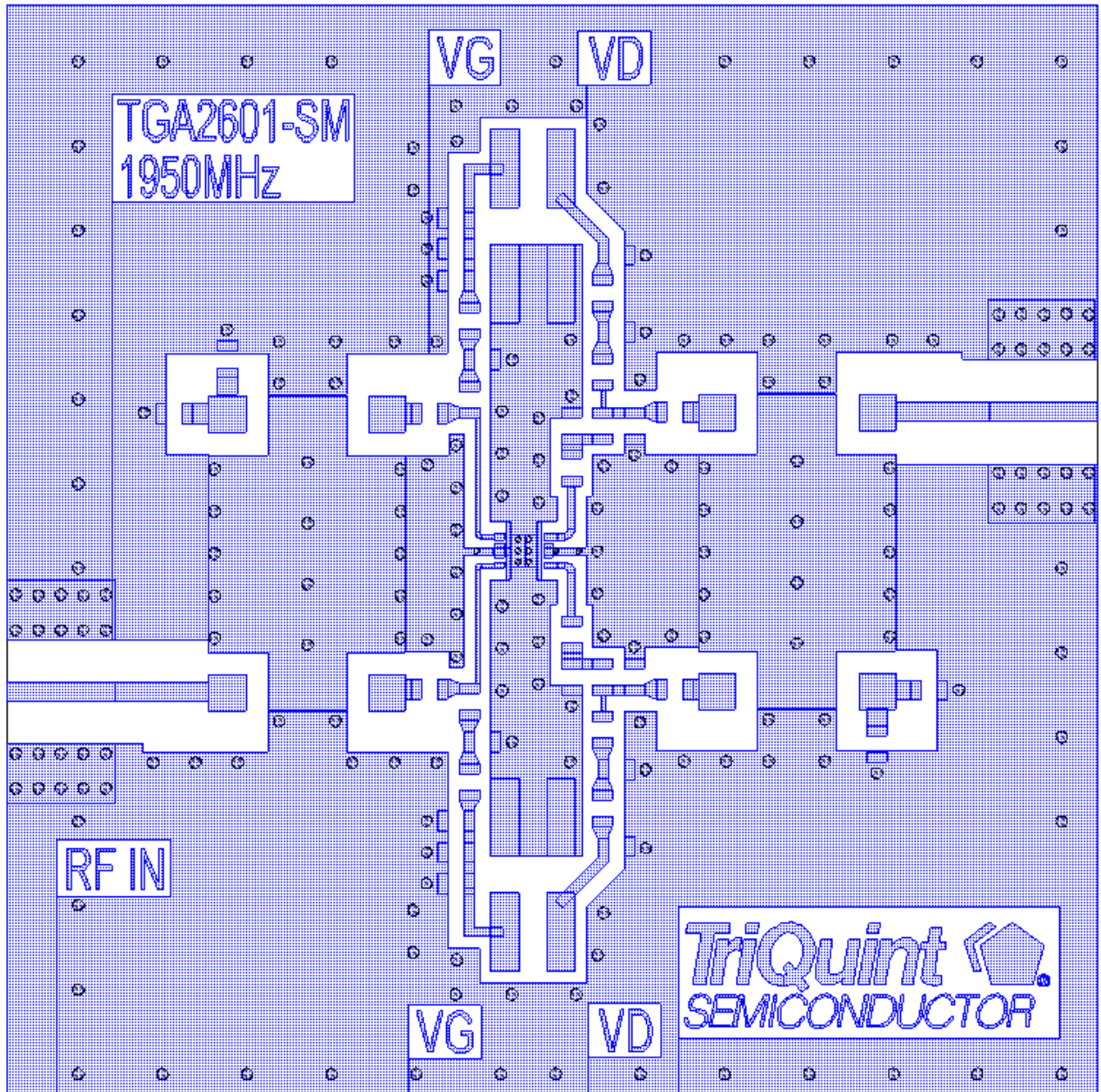



**Balanced Amplifier 2600 MHz Circuit Schematic**

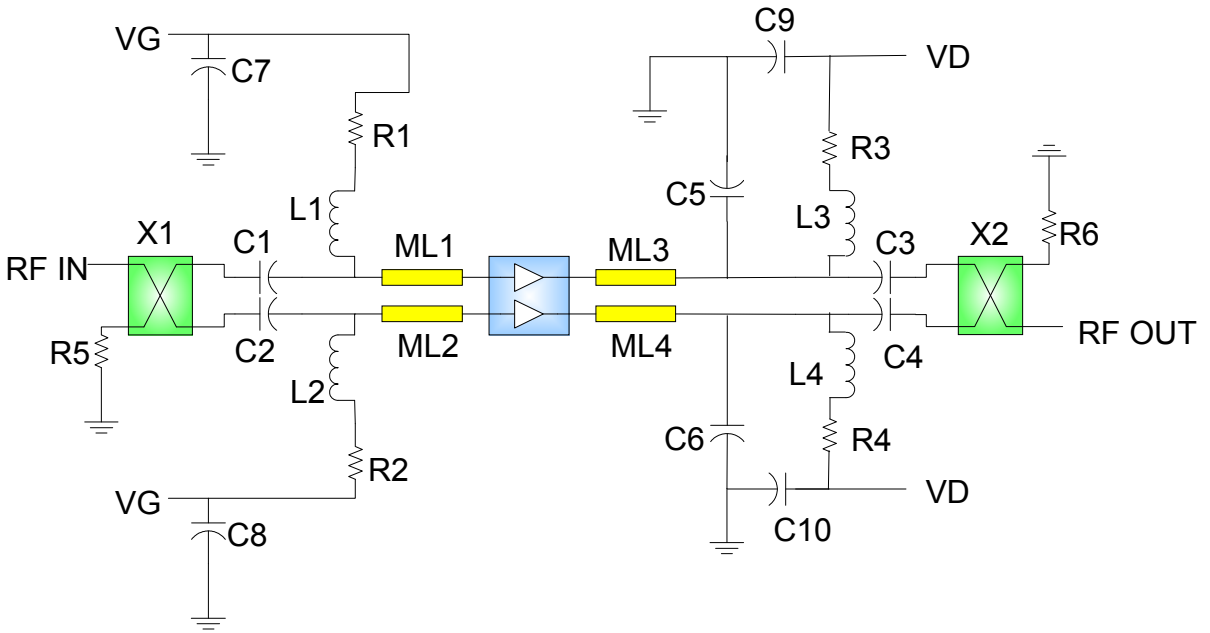

Designator	Description	Vendor
C1, C2	4.7 pF (0603)	
C3, C4	10 pF (0603)	
C5, C6	1pF (0603)	
C7, C8, C9, C10	1 uF (0603)	
R1, R2, R3, R4	10 Ohm (0603)	
R5, R6	50 Ohm (0603)	
L1, L2, L3, L4	47 nH (0603)	
X1, X2	XC2500A-03	Anaren

Designator	Impedance	Electrical Length @ 2.6 GHz
ML1, ML2	100 Ohm	28 Degree
ML3, ML4	90 Ohm	12 Degree

**2600 MHz Balanced Amplifier Layout**

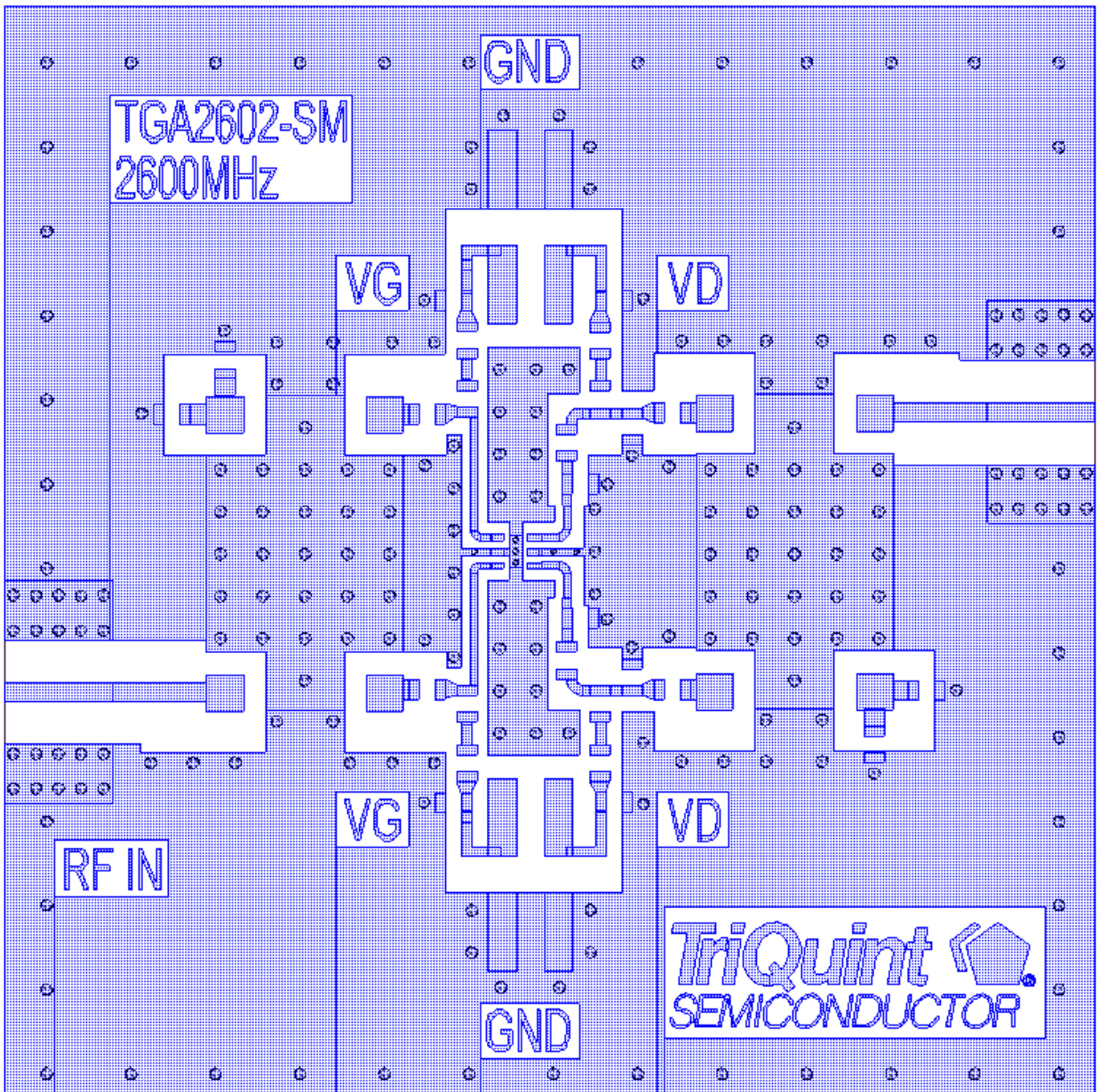

**Package Pinout Diagram**

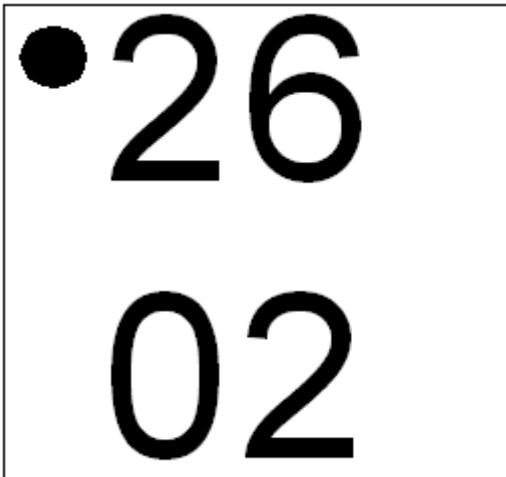

Top View

Dot indicates Pin 1

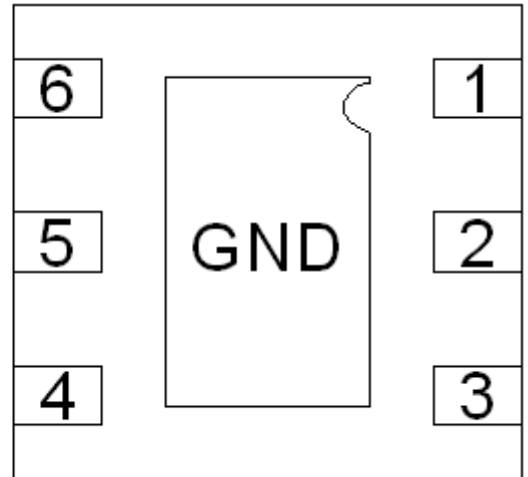

Bottom View

Pin	Description
1	RF In A / VgA
2,5	N/C
3	RF In B / VgB
4	RF Out B / VdB
6	RF Out A / VdA

***GaAs MMIC devices are susceptible to damage from Electrostatic Discharge. Proper precautions should be observed during handling, assembly and test.***

**Mechanical Drawing**

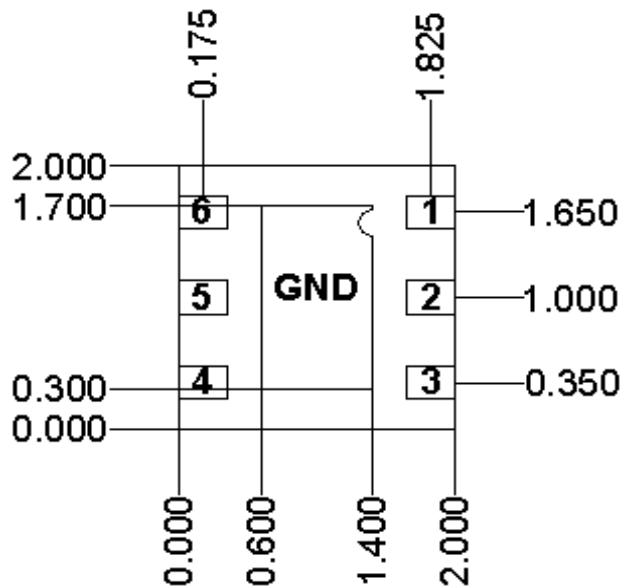

**Package Height = 0.9 mm max.**  
**Package dimensions are in mm. Unless otherwise specified, package tolerances are  $\pm 0.050$ mm.**

<b>Package Pad #1</b>	<b>RF In A / VgA</b>	<b>0.350 x 0.250</b>
<b>Package Pad #2</b>	<b>N/C</b>	<b>0.350 x 0.250</b>
<b>Package Pad #3</b>	<b>RF In B / VgB</b>	<b>0.350 x 0.250</b>
<b>Package Pad #4</b>	<b>RF Out B / VdB</b>	<b>0.350 x 0.250</b>
<b>Package Pad #5</b>	<b>N/C</b>	<b>0.350 x 0.250</b>
<b>Package Pad #6</b>	<b>RF Out A / VdA</b>	<b>0.350 x 0.250</b>

## Recommended Surface Mount Package Assembly

Proper ESD precautions must be followed while handling packages.

Clean the board with acetone. Rinse with alcohol. Allow the circuit to fully dry.

TriQuint recommends using a conductive solder paste for attachment. Follow solder paste and reflow oven vendors' recommendations when developing a solder reflow profile. Typical solder reflow profiles are listed in the table below.

Hand soldering is not recommended. Solder paste can be applied using a stencil printer or dot placement. The volume of solder paste depends on PCB and component layout and should be well controlled to ensure consistent mechanical and electrical performance. *This package has little tendency to self-align during reflow.*

Clean the assembly with alcohol.

### Typical Solder Reflow Profiles

Reflow Profile	SnPb	Pb Free
Ramp-up Rate	3 °C/sec	3 °C/sec
Activation Time and Temperature	60 – 120 sec @ 140 – 160 °C	60 – 180 sec @ 150 – 200 °C
Time above Melting Point	60 – 150 sec	60 – 150 sec
Max Peak Temperature	240 °C	260 °C
Time within 5 °C of Peak Temperature	10 – 20 sec	10 – 20 sec
Ramp-down Rate	4 – 6 °C/sec	4 – 6 °C/sec

### Ordering Information

Part	Package Style
TGA2602-SM	2x2 6 Lead QFN

***GaAs MMIC devices are susceptible to damage from Electrostatic Discharge. Proper precautions should be observed during handling, assembly and test.***