

Applications

- W-CDMA / LTE
- Macrocell Base Station
- Active Antenna
- General Purpose Applications



2 Lead NI400 Package

Product Features

- Operating Frequency Range: 2.5 – 2.7 GHz
- Operating Drain Voltage: 48 V
- Maximum Output Power (P_{SAT}): 200 W
- Maximum Drain Efficiency: 72%
- Efficiency-Tuned P3dB Gain: 20 dB
- 2-lead, earless, ceramic flange NI400 package

Functional Block Diagram

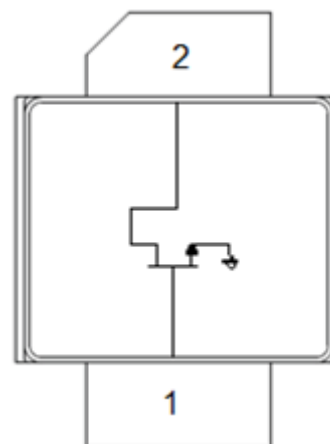

General Description

The QPD2796 is a discrete GaN on SiC HEMT which operates from 2.5–2.7 GHz. The device is a single stage matched power amplifier transistor.

The QPD2796 can be used in Doherty architecture for the final stage of a base station power amplifier for macrocell high efficiency systems.

QPD2796 can deliver P_{SAT} of 200 W at 48 V operation.

Lead-free and ROHS compliant.

Pin Configuration

Pin No.	Label
1	RF IN, V_G
2	RF OUT, V_D
Backside Paddle	RF/DC Ground

Ordering Information

Part No.	ECCN	Description
QPD2796	EAR99	200 W, 2.5-2.7 GHz, GaN RF Power Transistor

Absolute Maximum Ratings

Parameter	Rating
Gate Voltage (V_G)	-10 V
Drain Voltage (V_D)	+55 V
Peak RF Input Power	40 dBm
VSWR Mismatch, P1dB Pulse (20% duty cycle, 100 μ width), $T = 25^\circ\text{C}$	10:1
Storage Temperature	-65 to +150 $^\circ\text{C}$

Operation of this device outside the parameter ranges given above may cause permanent damage.

Recommended Operating Conditions

Parameter	Min	Typ	Max	Units
Operating Temperature	-40			$^\circ\text{C}$
Gate Voltage (V_G)		-2.7		V
Drain Voltage (V_D)		48		V
Quiescent Current (I_{CQ})		360		mA
T_{CH} for $>10^6$ hours MTTF			225	$^\circ\text{C}$

Electrical performance is measured under conditions noted in the electrical specifications table. Specifications are not guaranteed over all recommended operating conditions.

RF Characterization – Power-Tuned Load Pull Performance

Test conditions unless otherwise noted: $V_D = 48$ V, $I_{DQ} = 360$ mA, $T = 25^\circ\text{C}$, Pulsed (10% duty cycle, 100 μs width)

Frequency (MHz)	Source Impedance	Load Impedance	Gain @ P3dB (dB)	P3dB (dBm)	Drain Efficiency (%)
2500	4.19 - j7.30	15.21 + j3.95	18.07	52.99	57.79
2600	7.50 - j10.00	13.14 + j3.66	18.30	53.08	60.41
2700	8.00 - j8.00	10.89 + j5.55	18.62	52.93	60.78

RF Characterization – Efficiency-Tuned Load Pull Performance

Test conditions unless otherwise noted: $V_D = 48$ V, $I_{DQ} = 360$ mA, $T = 25^\circ\text{C}$, Pulsed (10% duty cycle, 100 μs width)

Frequency (MHz)	Source Impedance	Load Impedance	Gain @ P3dB (dB)	P3dB (dBm)	Drain Efficiency (%)
2500	4.19 - j7.30	12.03 - j9.90	19.92	51.45	72.09
2600	7.50 - j10.00	12.39 - j11.45	20.27	50.49	72.77
2700	8.00 - j8.00	14.88 - j2.48	19.96	51.67	71.66

Thermal Information

Parameter	Conditions	Value	Units
Thermal Resistance at Average Power (θ_{JC})	$T_{CASE} = 85^{\circ}C$, $T_{CH} = 175^{\circ}C$ CW: $P_{DISS} = 60.9 W$, $P_{OUT} = 56 W$	1.47	$^{\circ}C/W$

Notes:

1. Thermal resistance measured to package backside.
2. Based on expected carrier amplifier efficiency of Doherty.
3. Pout assumes 20% peaking amplifier contribution of total average Doherty rated power.

Median Lifetime

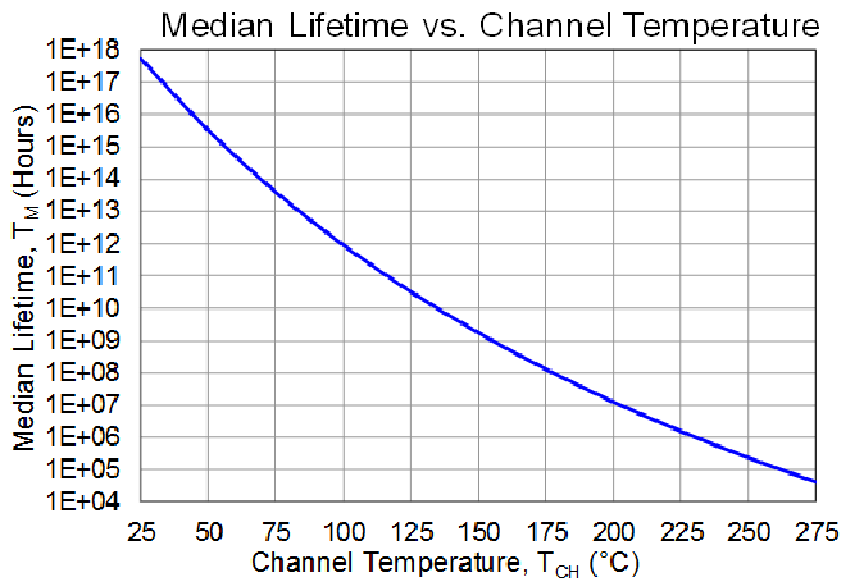

Load Pull Plots

Test conditions unless otherwise noted: $V_D = 48\text{ V}$, $I_{CQ} = 360\text{ mA}$, $T = 25^\circ\text{C}$, Pulsed (10% duty cycle, 100 μs width)

Load Pull at 2.5 GHz

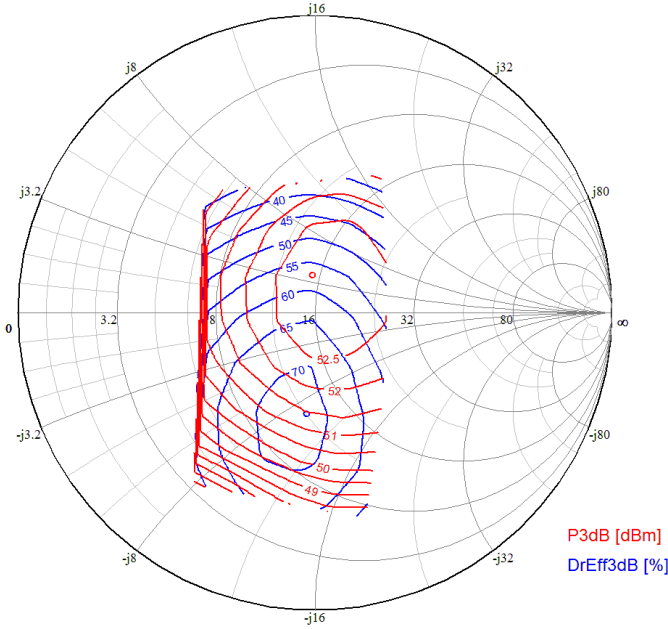

Load Pull at 2.6 GHz

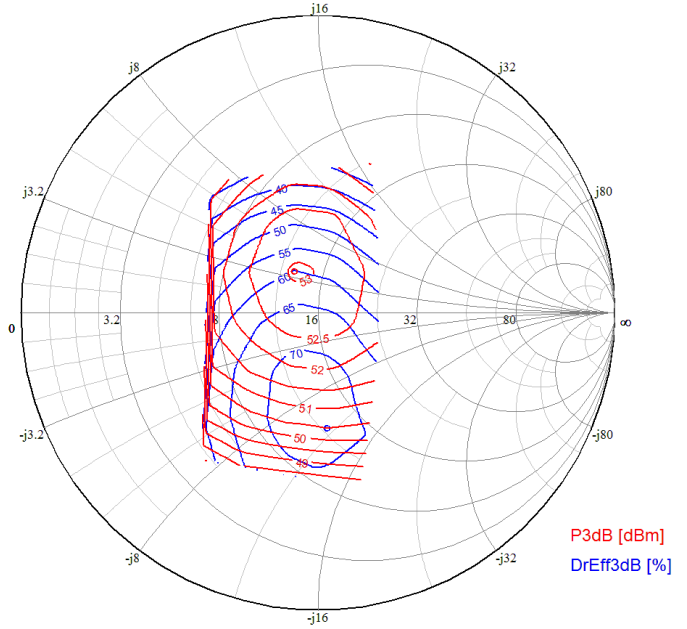

Load Pull at 2.7 GHz

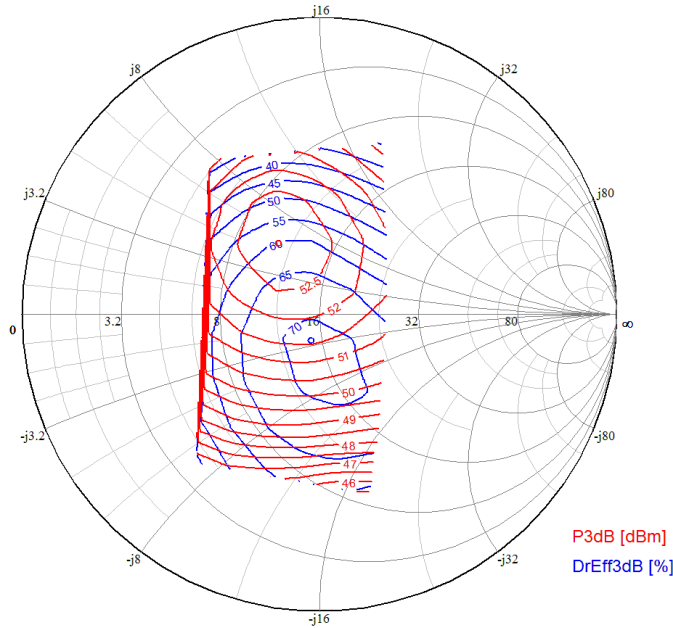

Pin Configuration and Description



TOP VIEW

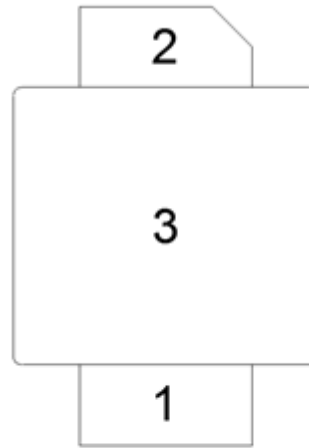

BOTTOM VIEW

Pin No.	Label	Description
1	RF IN, V_G	RF Input, Gate Bias
2	RF OUT, V_D	RF Output, Drain Bias
3 (Backside Paddle)	RF/DC GND	RF/DC Ground

Package Marking and Dimensions

Marking: Product Name – QPD2796
 Year/Week Code– YYWW
 Production Lot Number – MXXX
 Serial Number – ZZZ

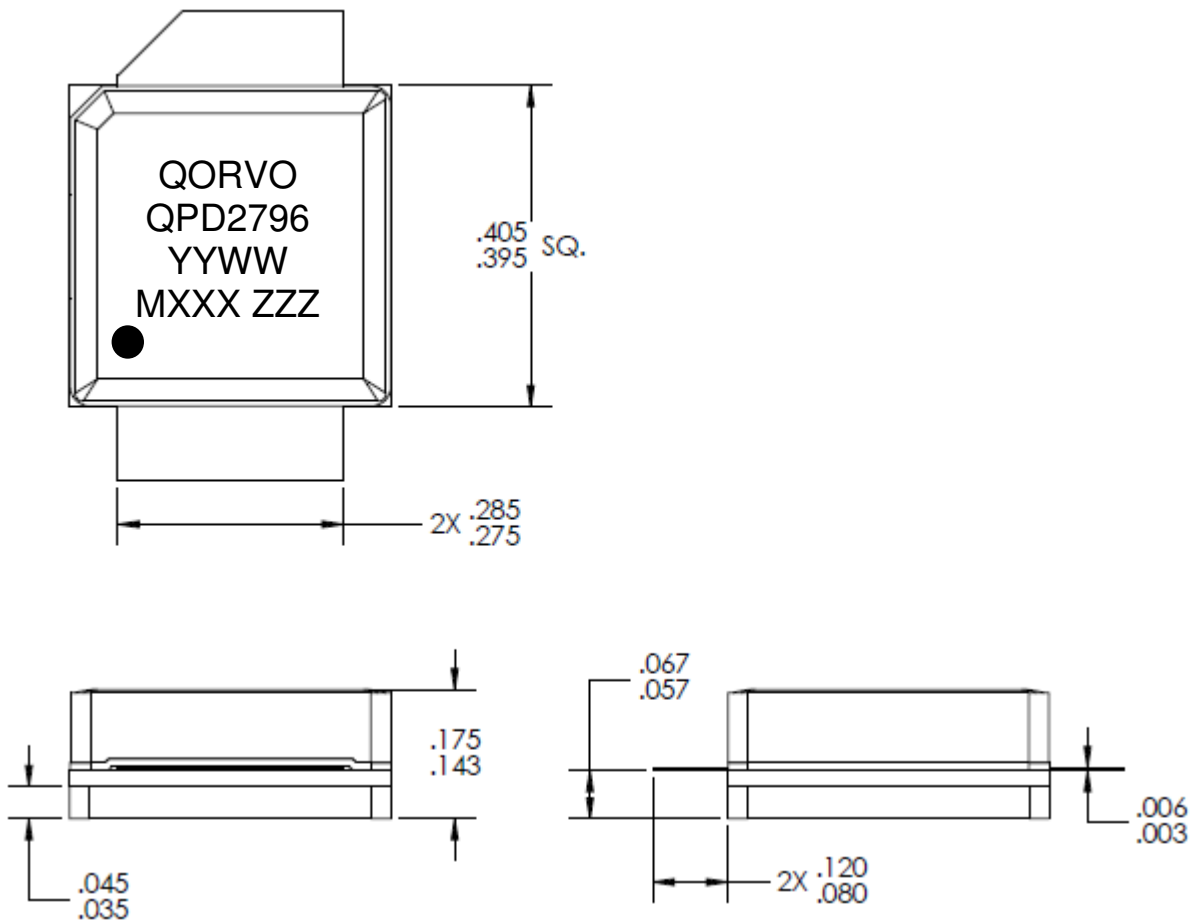

- Notes:
1. All dimensions are in inches. Angles are in degrees.
 2. Exposed metallization is NiAu plated.

Product Compliance Information

ESD Sensitivity Ratings



Caution! ESD-Sensitive Device

ESD Class: TBD

Volt. Range: TBD

Test: Human Body Model (HBM)

Standard: JEDEC Standard JS-001-2012

ESD Class: TBD

Range: TBD

Test: Charged Device Model (CDM)

Standard: JEDEC Standard JESD22-C101F

MSL Rating

MSL Rating: TBD

Test: 260 °C convection reflow

Standard: JEDEC Standard IPC/JEDEC J-STD-020

ECCN

US Department of Commerce EAR99

Solderability

Compatible with both lead-free (260 °C maximum reflow temperature) and tin/lead (245 °C maximum reflow temperature) soldering processes.

Contact plating: NiAu

RoHS Compliance

This part is compliant with EU 2002/95/EC RoHS directive (Restrictions on the Use of Certain Hazardous Substances in Electrical and Electronic Equipment).

This product also has the following attributes:

- Lead Free
- Antimony Free
- TBBP-A (C₁₅H₁₂Br₄O₂) Free
- PFOS Free
- SVHC Free

Contact Information

For the latest specifications, additional product information, worldwide sales and distribution locations:

Web: www.triquint.com

Tel: 877-800-8584

Email: customer.support@qorvo.com

For information about the merger of RFMD and TriQuint as Qorvo:

Web: www.qorvo.com

For technical questions and application information:

Email: btsapplications@tqs.com

Important Notice

The information contained herein is believed to be reliable. TriQuint makes no warranties regarding the information contained herein. TriQuint assumes no responsibility or liability whatsoever for any of the information contained herein. TriQuint assumes no responsibility or liability whatsoever for the use of the information contained herein. The information contained herein is provided "AS IS, WHERE IS" and with all faults, and the entire risk associated with such information is entirely with the user. All information contained herein is subject to change without notice. Customers should obtain and verify the latest relevant information before placing orders for TriQuint products. The information contained herein or any use of such information does not grant, explicitly or implicitly, to any party any patent rights, licenses, or any other intellectual property rights, whether with regard to such information itself or anything described by such information.

TriQuint products are not warranted or authorized for use as critical components in medical, life-saving, or life-sustaining applications, or other applications where a failure would reasonably be expected to cause severe personal injury or death.