

< Silicon RF Power MOS FET (Discrete) >

RD12MVS1

RoHS Compliant, Silicon MOSFET Power Transistor, 175MHz, 12W

DESCRIPTION

RD12MVS1 is a MOS FET type transistor specifically designed for VHF RF power amplifiers applications.

FEATURES

High Power Gain:

$P_{out} > 11.5W$, $G_p > 12dB$ @ $V_{dd} = 7.2V, f = 175MHz$

High Efficiency: 57%typ. (175MHz)

APPLICATION

For output stage of high power amplifiers in VHF band mobile radio sets.

OUTLINE DRAWING

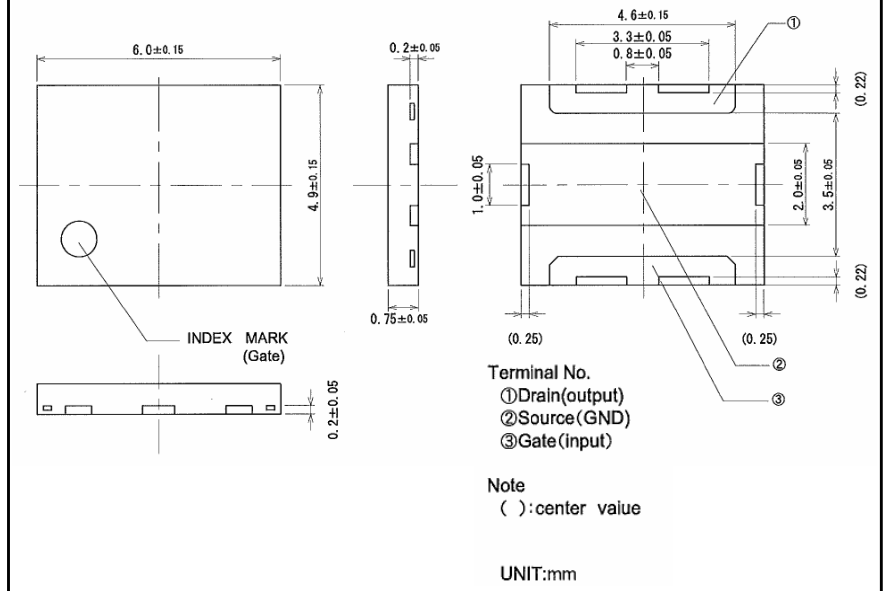

RoHS COMPLIANT

RD12MVS1 is EU RoHS compliant product.

RoHS compliant product is indicating by the letter "ZG" after the Lot Marking.

ABSOLUTE MAXIMUM RATINGS

($T_c = 25^\circ C$, UNLESS OTHERWISE NOTED)

SYMBOL	PARAMETER	CONDITIONS	RATINGS	UNIT
V_{DSS}	Drain to Source Voltage	$V_{GS} = 0V$	50	V
V_{GSS}	Gate to Source Voltage	$V_{DS} = 0V$	+/- 20	V
I_D	Drain Current		4	A
P_{in}	Input Power	$Z_g = Z_l = 50\Omega$	2	W
P_{ch}	Channel Dissipation	$T_c = 25^\circ C$	50	W
T_j	Junction Temperature		150	$^\circ C$
T_{stg}	Storage Temperature		-40 to +125	$^\circ C$
R_{thj-c}	Thermal Resistance	Junction to Case	2.5	$^\circ C/W$

Note: Above parameters are guaranteed independently.

RD12MVS1

RoHS Compliant, Silicon MOSFET Power Transistor, 175MHz, 12W

ELECTRICAL CHARACTERISTICS (T_c=25°C, UNLESS OTHERWISE NOTED)

SYMBOL	PARAMETER	CONDITIONS	LIMITS			UNIT
			MIN.	TYP.	MAX.	
I _{DSS}	Zero Gate Voltage Drain Current	V _{DS} =17V, V _{GS} =0V	-	-	10	uA
I _{GSS}	Gate to Source Leak Current	V _{GS} =10V, V _{DS} =0V	-	-	1	uA
V _{TH}	Gate Threshold Voltage	V _{DS} =12V, I _{DS} =1mA	1.8	-	4.4	V
P _{out}	Output Power	f=175MHz, V _{DD} =7.2V	11.5	12	-	W
η _D	Drain Efficiency	P _{in} =1.0W, I _{dq} =1.0A	55	57	-	%
	Load VSWR tolerance	V _{DD} =9.2V, P _o =12W(Pin Control) f=175MHz, I _{dq} =1.0A, Z _g =50Ω Load VSWR=20:1(All Phase)	Not destroy			-

Note: Above parameters, ratings, limits and conditions are subject to change.

RD12MVS1

RoHS Compliant, Silicon MOSFET Power Transistor, 175MHz, 12W

TYPICAL CHARACTERISTICS

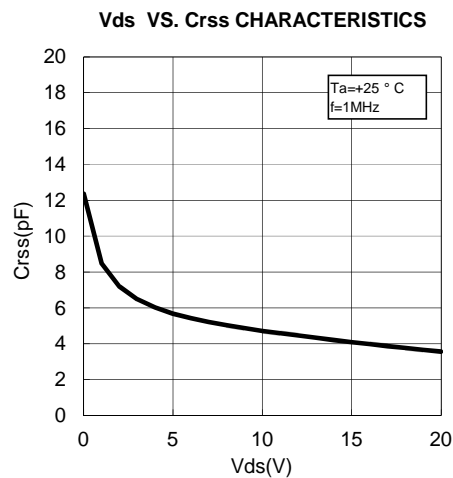
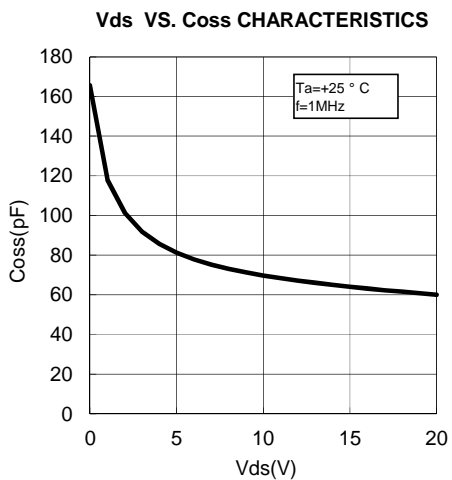
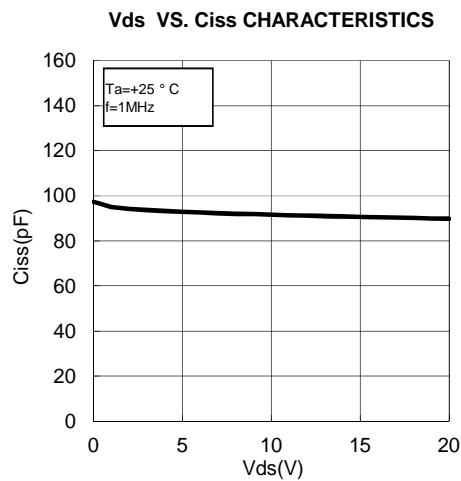
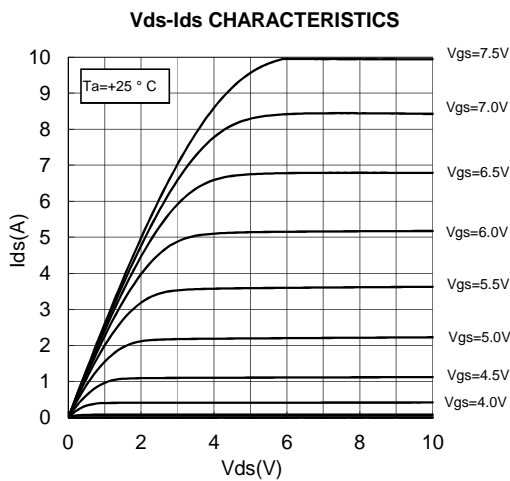
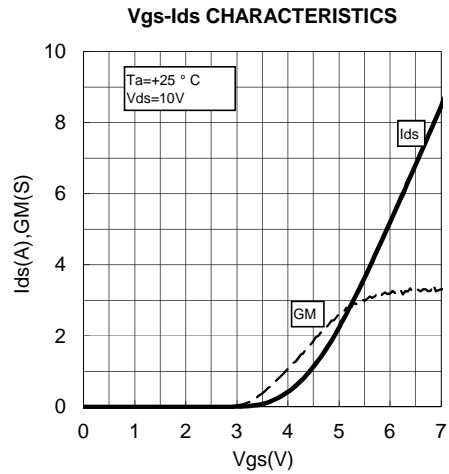
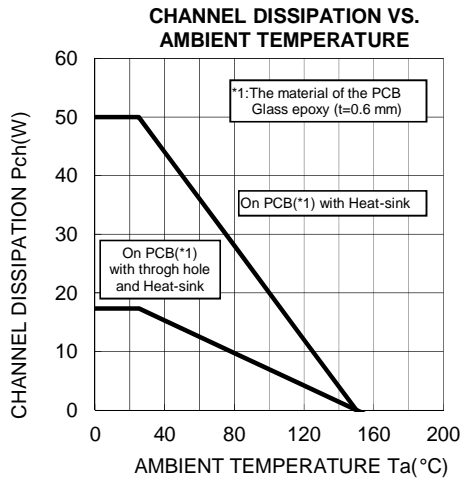

RD12MVS1

RoHS Compliant, Silicon MOSFET Power Transistor, 175MHz, 12W

TYPICAL CHARACTERISTICS

Pin-Po CHARACTERISTICS @f=175MHz

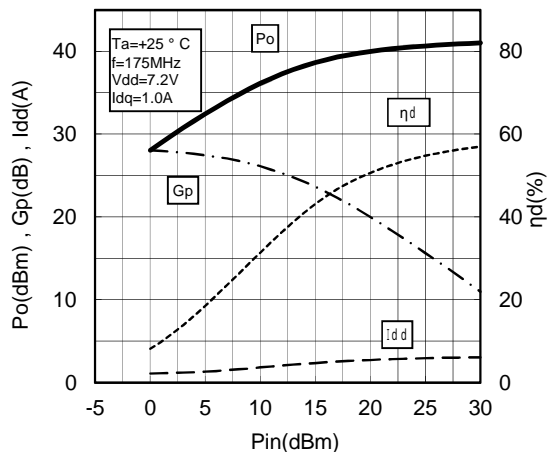

Pin-Po CHARACTERISTICS @f=175MHz

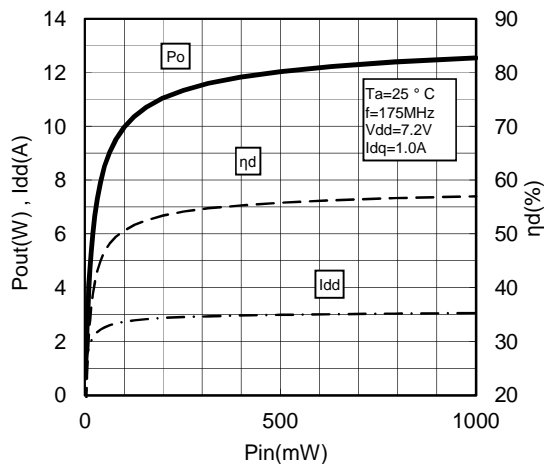

Vdd-Po CHARACTERISTICS @f=175MHz

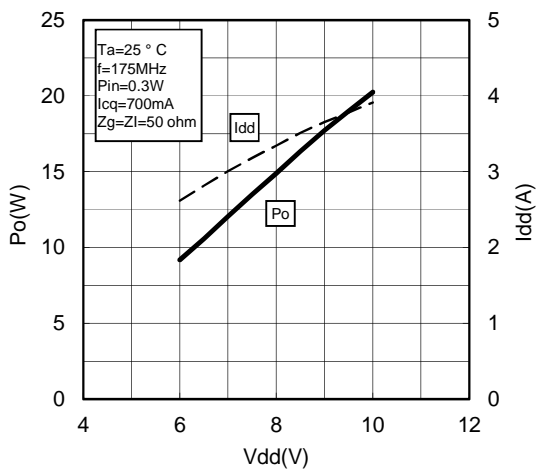

Vgs-Ids CHARACTERISTICS 2

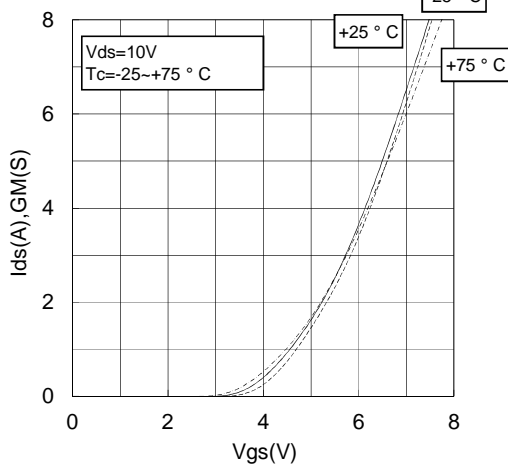

RD12MVS1

RoHS Compliant, Silicon MOSFET Power Transistor, 175MHz, 12W

TEST CIRCUIT (f=175MHz)

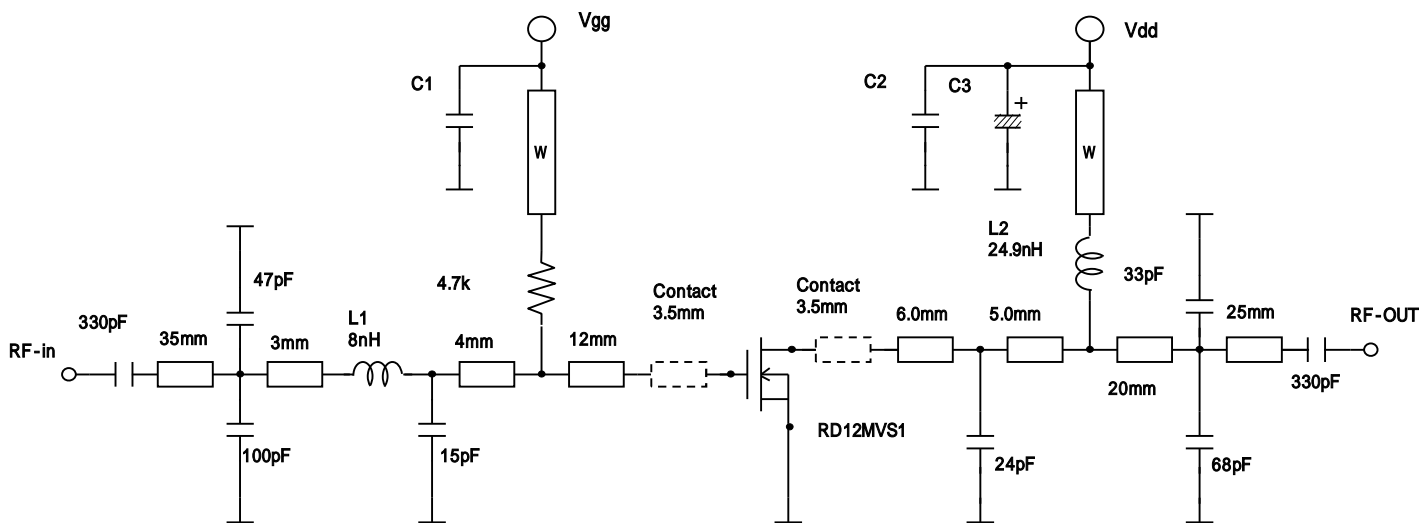

Note: Board material PTFE substrate
 Micro strip line width=2.2mm/50, er:2.7, t=0.8mm
 W: Line width=1.0mm
 Chip Condenser :GRM40
 Copper Board spring t=0.1mm

L: Enameled Wire
 L1: 4Tums, D:0.43mm, 1.66mm(outside diameter)
 L2: 6Tums, D:0.43mm, 2.46mm(outside diameter)
 C1, C2: 1000pF
 C3: 10 μF, 50V

INPUT / OUTPUT IMPEDANCE VS. FREQUENCY CHARACTERISTICS

175MHz Z_{in}^* Z_{out}^*
 $Z_0=50\Omega$

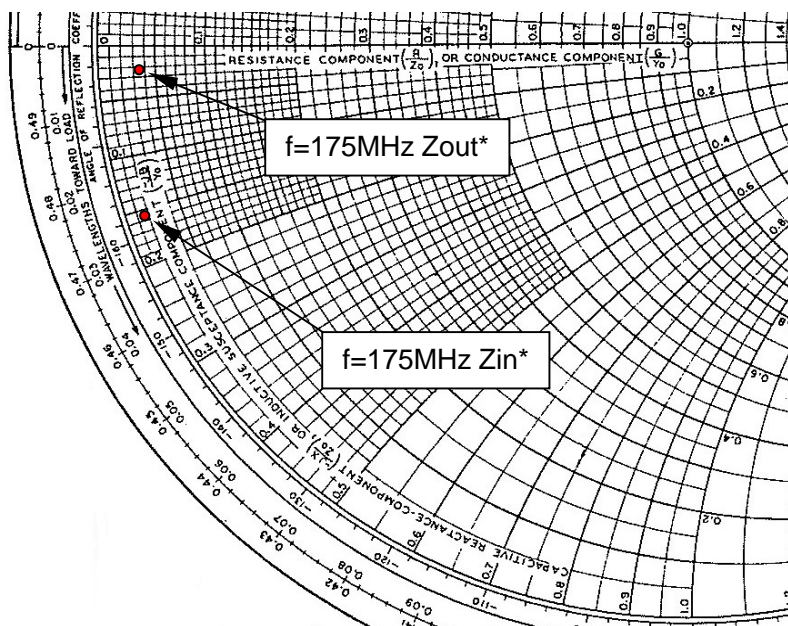

Vdd=7.2V, Idq=1.0A(Vgg adj.), Pin=1.0W

$Z_{in}^*=0.965-j7.73$
 $Z_{out}^*=1.73-j1.14$

Z_{in}^* : Complex conjugate of input impedance
 Z_{out}^* : Complex conjugate of output impedance

RD12MVS1

RoHS Compliant, Silicon MOSFET Power Transistor, 175MHz, 12W

RD12MVS1 S-PARAMETER DATA (@Vdd=7.2V, Id=900mA)

Freq. [MHz]	S11		S21		S12		S22	
	(mag)	(ang)	(mag)	(ang)	(mag)	(ang)	(mag)	(ang)
25	0.824	-159.3	26.397	93.4	0.018	-3.3	0.761	-160.3
50	0.816	-169.0	13.193	85.2	0.016	1.4	0.765	-168.1
75	0.817	-171.7	8.716	79.3	0.016	-10.9	0.778	-170.7
100	0.829	-172.8	6.537	74.5	0.016	-14.1	0.787	-170.3
125	0.837	-173.4	5.110	68.5	0.016	-18.2	0.800	-171.7
150	0.845	-173.9	4.117	64.2	0.015	-18.3	0.796	-172.3
175	0.852	-174.0	3.402	60.8	0.016	-15.1	0.810	-172.3
200	0.860	-174.3	2.896	57.2	0.012	-30.4	0.836	-172.2
225	0.870	-175.0	2.525	53.2	0.014	-29.9	0.858	-172.2
250	0.876	-175.0	2.175	48.9	0.013	-24.5	0.855	-173.0
275	0.886	-175.6	1.897	46.5	0.012	-39.4	0.859	-173.3
300	0.891	-175.8	1.675	43.6	0.012	-53.1	0.860	-173.4
325	0.902	-175.9	1.496	41.0	0.014	-32.9	0.886	-174.5
350	0.903	-176.2	1.348	38.3	0.012	-32.2	0.898	-174.6
375	0.909	-176.7	1.208	35.7	0.009	-29.2	0.898	-175.0
400	0.907	-177.6	1.087	33.7	0.009	-21.6	0.893	-175.6
425	0.912	-177.9	0.996	31.6	0.009	-32.5	0.903	-175.7
450	0.923	-178.3	0.912	29.7	0.004	-37.2	0.910	-176.6
475	0.928	-178.5	0.836	27.9	0.008	-25.9	0.917	-176.8
500	0.934	-178.6	0.748	25.8	0.007	-21.3	0.925	-177.3
525	0.932	-178.8	0.707	23.6	0.005	-46.6	0.922	-177.6
550	0.936	-179.2	0.647	23.2	0.006	-25.0	0.922	-177.6
575	0.932	179.6	0.591	20.8	0.004	-40.9	0.939	-178.0
600	0.935	179.1	0.562	20.0	0.003	-33.6	0.939	-178.9
625	0.939	179.2	0.520	17.4	0.003	17.7	0.938	-179.3
650	0.939	179.4	0.485	15.5	0.003	25.4	0.930	-179.5
675	0.943	179.1	0.460	15.6	0.003	51.4	0.932	-179.9
700	0.945	178.7	0.435	15.5	0.002	5.7	0.946	-179.9
725	0.943	177.5	0.407	13.3	0.004	5.6	0.949	179.3
750	0.939	177.2	0.380	12.2	0.001	-16.1	0.940	179.0
775	0.943	176.9	0.358	10.8	0.004	58.8	0.935	178.8
800	0.948	176.8	0.327	8.6	0.002	-6.7	0.943	178.2
825	0.951	177.1	0.308	8.0	0.003	40.4	0.945	177.5
850	0.953	176.7	0.314	8.5	0.003	77.0	0.948	176.8
875	0.952	176.1	0.284	7.0	0.006	46.5	0.946	176.7
900	0.954	175.4	0.269	9.7	0.003	64.5	0.950	176.7
925	0.944	174.4	0.254	6.7	0.007	60.3	0.946	176.0
950	0.951	174.6	0.250	6.0	0.006	69.7	0.952	175.7
975	0.954	175.0	0.232	1.9	0.003	80.3	0.959	175.0
1000	0.955	175.0	0.227	7.8	0.003	86.7	0.950	174.8

RD12MVS1

RoHS Compliant, Silicon MOSFET Power Transistor, 175MHz, 12W

ATTENTION:

- 1.High Temperature ; This product might have a heat generation while operation,Please take notice that have a possibility to receive a burn to touch the operating product directly or touch the product until cold after switch off. At the near the product,do not place the combustible material that have possibilities to arise the fire.
- 2.Generation of High Frequency Power ; This product generate a high frequency power. Please take notice that do not leakage the unnecessary electric wave and use this products without cause damage for human and property per normal operation.
- 3.Before use; Before use the product,Please design the equipment in consideration of the risk for human and electric wave obstacle for equipment.

PRECAUTIONS FOR THE USE OF MITSUBISHI SILICON RF POWER DEVICES:

1. The specifications of mention are not guarantee values in this data sheet. Please confirm additional details regarding operation of these products from the formal specification sheet. For copies of the formal specification sheets, please contact one of our sales offices.
- 2.RA series products (RF power amplifier modules) and RD series products (RF power transistors) are designed for consumer mobile communication terminals and were not specifically designed for use in other applications. In particular, while these products are highly reliable for their designed purpose, they are not manufactured under a quality assurance testing protocol that is sufficient to guarantee the level of reliability typically deemed necessary for critical communications elements and In the application, which is base station applications and fixed station applications that operate with long term continuous transmission and a higher on-off frequency during transmitting, please consider the derating, the redundancy system, appropriate setting of the maintain period and others as needed. For the reliability report which is described about predicted operating life time of Mitsubishi Silicon RF Products , please contact Mitsubishi Electric Corporation or an authorized Mitsubishi Semiconductor product distributor.
3. RD series products use MOSFET semiconductor technology. They are sensitive to ESD voltage therefore appropriate ESD precautions are required.
4. In the case of use in below than recommended frequency, there is possibility to occur that the device is deteriorated or destroyed due to the RF-swing exceed the breakdown voltage.
5. In order to maximize reliability of the equipment, it is better to keep the devices temperature low. It is recommended to utilize a sufficient sized heat-sink in conjunction with other cooling methods as needed (fan, etc.) to keep the channel temperature for RD series products lower than 120deg/C(in case of Tchmax=150deg/C) ,140deg/C(in case of Tchmax=175deg/C) under standard conditions.
6. Do not use the device at the exceeded the maximum rating condition. In case of plastic molded devices, the exceeded maximum rating condition may cause blowout, smoldering or catch fire of the molding resin due to extreme short current flow between the drain and the source of the device. These results causes in fire or injury.
7. For specific precautions regarding assembly of these products into the equipment, please refer to the supplementary items in the specification sheet.
8. Warranty for the product is void if the products protective cap (lid) is removed or if the product is modified in any way from it's original form.
9. For additional "Safety first" in your circuit design and notes regarding the materials, please refer the last page of this data sheet.
10. Please refer to the additional precautions in the formal specification sheet.

RD12MVS1

RoHS Compliant, Silicon MOSFET Power Transistor, 175MHz, 12W

Main Revision for this Edition

No	Date	Revision	
		Pages	Points
1	2011.10.7	1-9	• Revision by change of style of data sheet.
		5	• TEST CIRCUIT(f=175MHz) Note: The contents are changed. Note:Board material-Teflon substrate→Note:Board material-PTFE substrate
		7	• PRECAUTION FOR THE USE OF MITSUBISHI SILICON RF POWER AMPLIFIER DEVICES: 2 . The content of the above-mentioned item is changed. Before it corrects it 2.RA series products (RF power amplifier modules) are designed for consumer mobile communication terminals and were not specifically designed for use in other applications. In particular, while these products are highly reliable for their designed purpose, they are not manufactured under a quality assurance testing protocol that is sufficient to guarantee the level of reliability typically deemed necessary for critical communications elements. Examples of critical communications elements would include transmitters for base station applications and fixed station applications that operate with long term continuous transmission and a higher on-off frequency during transmitting, especially for systems that may have a high impact to society.
2	2014.9.3	1	Changed of the material that the Silver resin paste from the PbSnAg solder paste for the purpose of RoHS compliance. The reason of change is due to these applications, high-melting solder alloys are used,which is exception item at RoHS,and do not satisfy the requirements of RoHS. Also, Changed of the production site to THAILAND(MMT of EMS company) from JAPAN,change to the EMS company standard material for Leadframe material,SLP package size is thinned to a thickened of EMS company standard size (0.9mm to0.75mm),and back side metal of MOSFET wafer from adequate for PbSnAg solder:
		3-4	Replaced of graphs.

RD12MVS1

RoHS Compliant, Silicon MOSFET Power Transistor, 175MHz, 12W

Keep safety first in your circuit designs!

Mitsubishi Electric Corporation puts the maximum effort into making semiconductor products better and more reliable, but there is always the possibility that trouble may occur with them. Trouble with semiconductors may lead to personal injury, fire or property damage. Remember to give due consideration to safety when making your circuit designs, with appropriate measures such as (i) placement of substitutive, auxiliary circuits, (ii) use of non-flammable material or (iii) prevention against any malfunction or mishap.

Notes regarding these materials

- These materials are intended as a reference to assist our customers in the selection of the Mitsubishi semiconductor product best suited to the customer's application; they do not convey any license under any intellectual property rights, or any other rights, belonging to Mitsubishi Electric Corporation or a third party.
- Mitsubishi Electric Corporation assumes no responsibility for any damage, or infringement of any third-party's rights, originating in the use of any product data, diagrams, charts, programs, algorithms, or circuit application examples contained in these materials.
- All information contained in these materials, including product data, diagrams, charts, programs and algorithms represents information on products at the time of publication of these materials, and are subject to change by Mitsubishi Electric Corporation without notice due to product improvements or other reasons. It is therefore recommended that customers contact Mitsubishi Electric Corporation or an authorized Mitsubishi Semiconductor product distributor for the latest product information before purchasing a product listed herein.
The information described here may contain technical inaccuracies or typographical errors. Mitsubishi Electric Corporation assumes no responsibility for any damage, liability, or other loss rising from these inaccuracies or errors.
Please also pay attention to information published by Mitsubishi Electric Corporation by various means, including the Mitsubishi Semiconductor home page (<http://www.MitsubishiElectric.com/>).
- When using any or all of the information contained in these materials, including product data, diagrams, charts, programs, and algorithms, please be sure to evaluate all information as a total system before making a final decision on the applicability of the information and products. Mitsubishi Electric Corporation assumes no responsibility for any damage, liability or other loss resulting from the information contained herein.
- Mitsubishi Electric Corporation semiconductors are not designed or manufactured for use in a device or system that is used under circumstances in which human life is potentially at stake. Please contact Mitsubishi Electric Corporation or an authorized Mitsubishi Semiconductor product distributor when considering the use of a product contained herein for any specific purposes, such as apparatus or systems for transportation, vehicular, medical, aerospace, nuclear, or undersea repeater use.
- The prior written approval of Mitsubishi Electric Corporation is necessary to reprint or reproduce in whole or in part these materials.
- If these products or technologies are subject to the Japanese export control restrictions, they must be exported under a license from the Japanese government and cannot be imported into a country other than the approved destination.
Any diversion or re-export contrary to the export control laws and regulations of Japan and/or the country of destination is prohibited.
- Please contact Mitsubishi Electric Corporation or an authorized Mitsubishi Semiconductor product distributor for further details on these materials or the products contained therein.