

Features

- Broadband: 2 - 20 GHz
- Low insertion Loss: 1 dB
- High Isolation: 15 dB Typical
- Lead-Free 3 mm 16 Lead QFN Package

Applications

- Test and Measurement
- Mil Comms
- Multi-band Radios

Description

The MAPD-011062 is a full integrated power divider offering best in class isolation over the entire 2 - 20 GHz band.

Functional Schematic

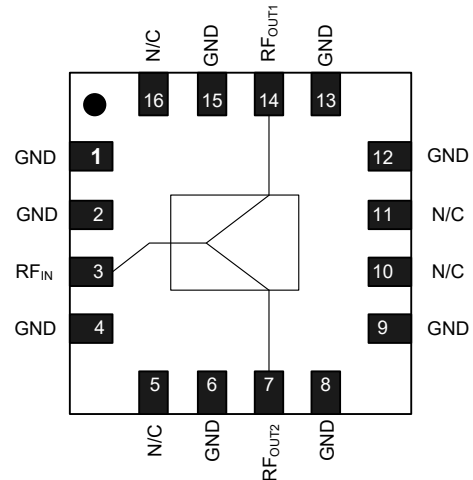

Pin Configuration

Pin #	Function
1, 2, 4, 6, 8, 9, 12, 13, 15	Ground
3	Input
5, 10, 11, 16	N/C ³
7	Output 2
14	Output 1
17	Paddle ⁴

Ordering Information^{1,2}

Part Number	Package
MAPD-011062-TR0500	500 Piece Reel
MAPD-011062-SB1	Sample Board

1. Reference Application Note M513 for reel size information.
2. All sample boards include 5 loose parts.

3. MACOM recommends connecting N/C pin to ground.
4. The exposed pad centered on the package bottom must be connected to PCB ground with low electrical and thermal resistances.

* Restrictions on Hazardous Substances, compliant to current RoHS EU directive.

Power Divider 2 - 20 GHz



MAPD-011062

Rev. V3

Electrical Specifications: Freq. = 2 - 20 GHz, $T_A = 25^\circ\text{C}$, $Z_0 = 50 \Omega$, $P_{IN} = 0 \text{ dBm}$

Parameter	Test Condition	Units	Min.	Typ.	Max.
Insertion Loss	2 - 13 GHz 13 - 18 GHz 18 - 20 GHz	dB	—	1	1.5 2.25 2.75
Amplitude Balance	2 - 20 GHz	dB	—	0.2	—
Phase Balance	2 - 20 GHz	°	—	2	—
Isolation	2 - 20 GHz	dB	—	15	—
Input Return Loss	2 - 20 GHz	dB	—	15	—
Output Return Loss	2 - 20 GHz	dB	—	17	—

Absolute Maximum Ratings^{5,6}

Parameter	Absolute Maximum
Input RF Power ⁷	3 W
DC Current	500 mA
Operating Temperature	-40°C to +105°C
Storage Temperature	-65°C to +150°C

5. Exceeding any one or combination of these limits may cause permanent damage to this device.
6. MACOM does not recommend sustained operation near these survivability limits.
7. Specified at +25°C only.

PCB Layout

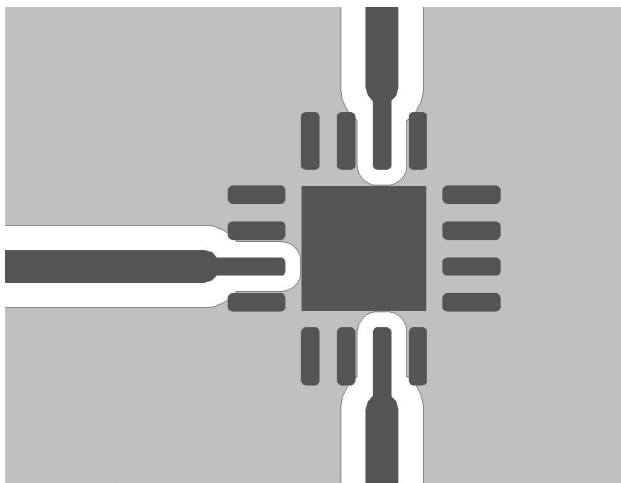

Application Schematic

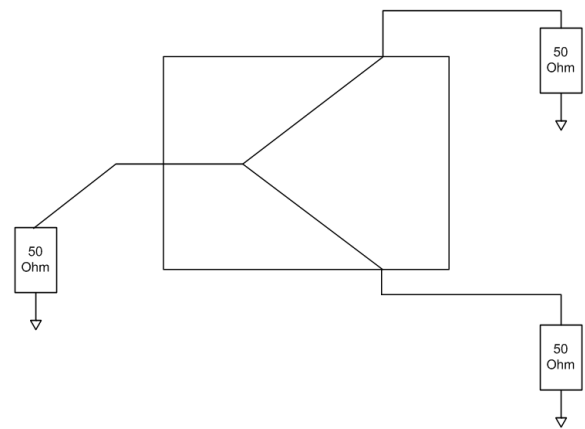

Typical Performance Curves

Insertion Loss 1 (ref. level -3 dB)

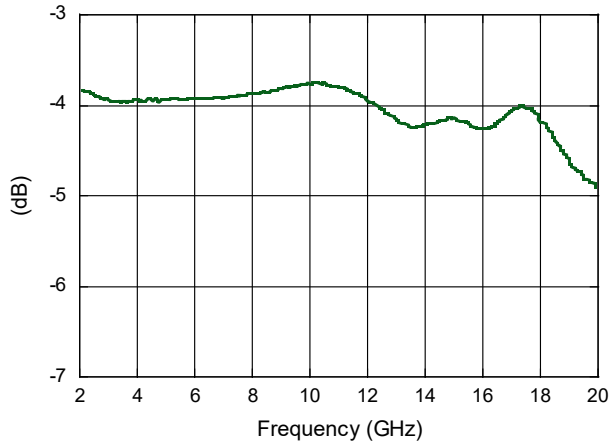

Insertion Loss 2 (ref. level -3 dB)

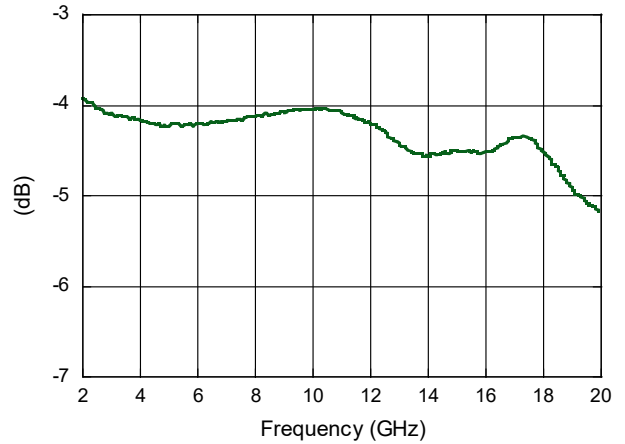

Amplitude Balance

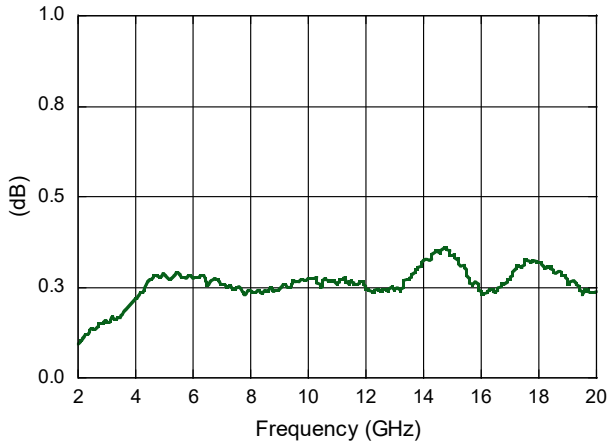

Phase Balance

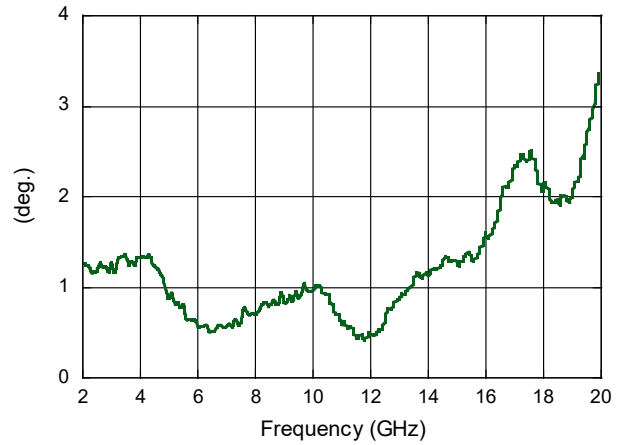

Power Divider 2 - 20 GHz



MAPD-011062

Rev. V3

Typical Performance Curves:

Isolation

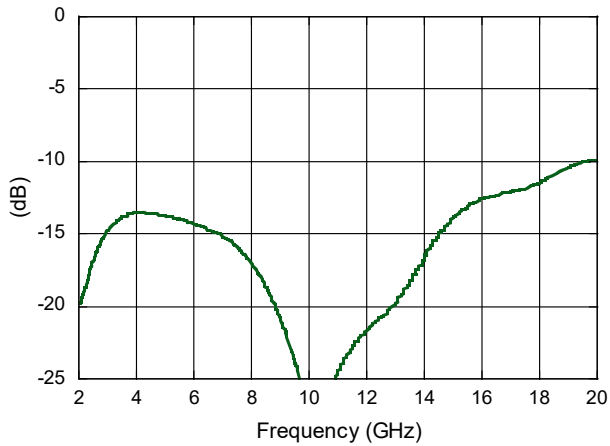

Input Return Loss

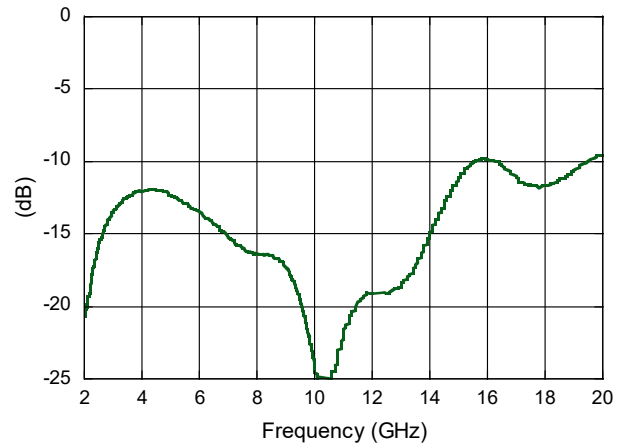

Output Return Loss 1

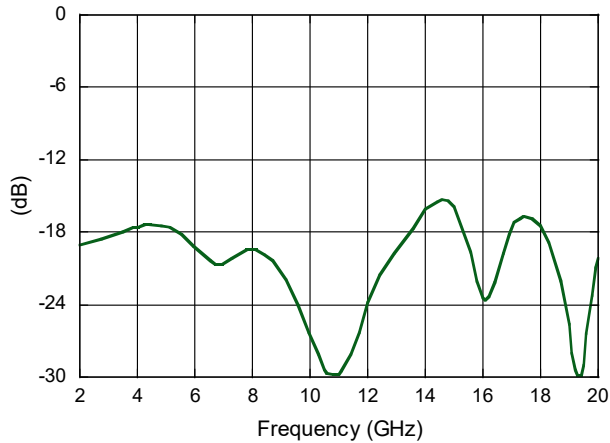

Output Return Loss 2

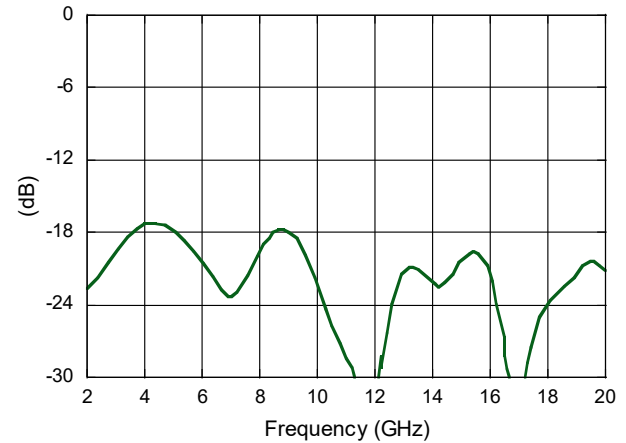

Lead-Free 3 mm 16-Lead PQFN[†]

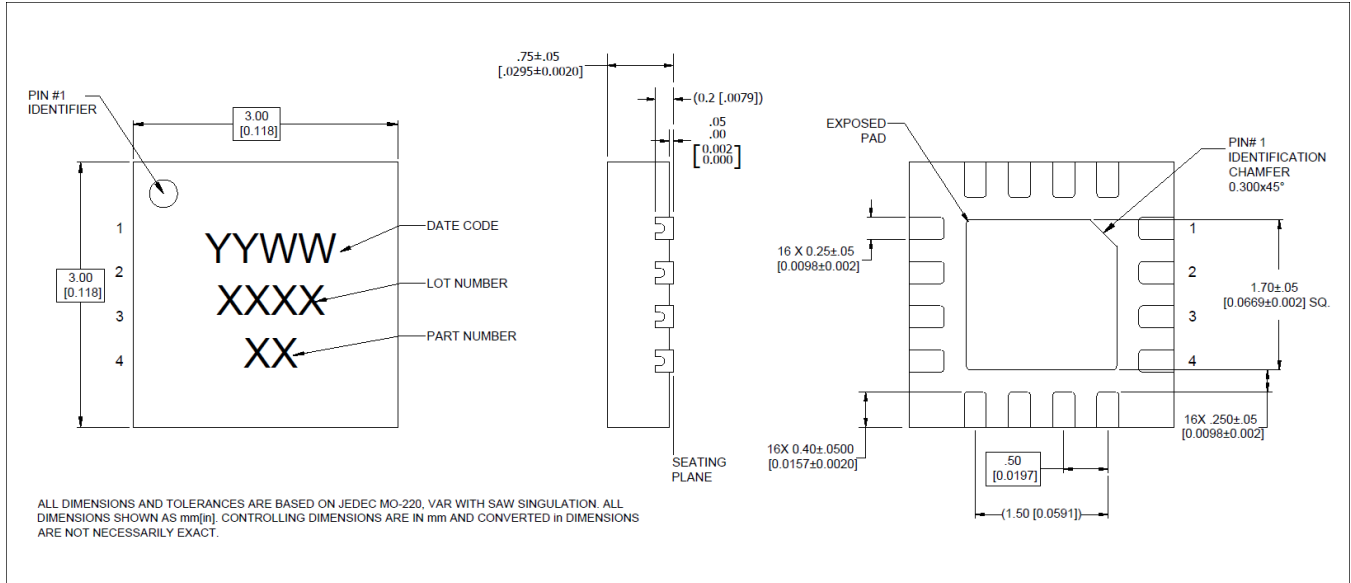

[†] Reference Application Note S2083 for lead-free solder reflow recommendations.
Meets JEDEC moisture sensitivity level (MSL) 3 requirements in accordance to JEDEC J-STD-020D.
Plating is 100% matte tin over copper.
Tolerance is ±0.05 mm unless otherwise noted.

MACOM Technology Solutions Inc. ("MACOM"). All rights reserved.

These materials are provided in connection with MACOM's products as a service to its customers and may be used for informational purposes only. Except as provided in its Terms and Conditions of Sale or any separate agreement, MACOM assumes no liability or responsibility whatsoever, including for (i) errors or omissions in these materials; (ii) failure to update these materials; or (iii) conflicts or incompatibilities arising from future changes to specifications and product descriptions, which MACOM may make at any time, without notice. These materials grant no license, express or implied, to any intellectual property rights.

THESE MATERIALS ARE PROVIDED "AS IS" WITH NO WARRANTY OR LIABILITY, EXPRESS OR IMPLIED, RELATING TO SALE AND/OR USE OF MACOM PRODUCTS INCLUDING FITNESS FOR A PARTICULAR PURPOSE, MERCHANTABILITY, INFRINGEMENT OF INTELLECTUAL PROPERTY RIGHT, ACCURACY OR COMPLETENESS, OR SPECIAL, INDIRECT, INCIDENTAL, OR CONSEQUENTIAL DAMAGES WHICH MAY RESULT FROM USE OF THESE MATERIALS.

MACOM products are not intended for use in medical, lifesaving or life sustaining applications. MACOM customers using or selling MACOM products for use in such applications do so at their own risk and agree to fully indemnify MACOM for any damages resulting from such improper use or sale.