

Features

- Low Series Resistance
- Low Capacitance
- High Cutoff Frequency
- Silicon Nitride Passivation
- Polyimide Scratch Protection
- Designed for Easy Circuit Insertion

Description and Applications

The MA4E1317 single, MA4E1318 anti-parallel pair, MA4E1319-1 reverse tee, MA4E1319-2 series tee and MA4E2160 unconnected anti-parallel pair are gallium arsenide flip chip Schottky barrier diodes.

These devices are fabricated on OMCVD epitaxial wafers using a process designed for high device uniformity and extremely low parasitics. The diodes are fully passivated with silicon nitride and have an additional layer of polyimide for scratch protection. The protective coatings prevent damage to the junction during automated or manual handling. The flip chip configuration is suitable for pick and place insertion. The high cutoff frequency of these diodes allows use through millimeter wave frequencies.

Typical applications include single and double balanced mixers in PCN transceivers and radios, police radar detectors, and automotive radar detectors. The devices can be used through 80 GHz.

The MA4E1318 anti-parallel pair is designed for use in sub harmonically pumped mixers. Close matching of the diode characteristics results in high LO suppression at the RF input.

Ordering Information

Part Number	Package
MA4E1317 MA4E1318 MA4E1319-1 MA4E1319-2 MA4E2160	100 piece Gel Pack
MADS-001317-1278HP MADS-001318-1197HP	3000 piece Reel

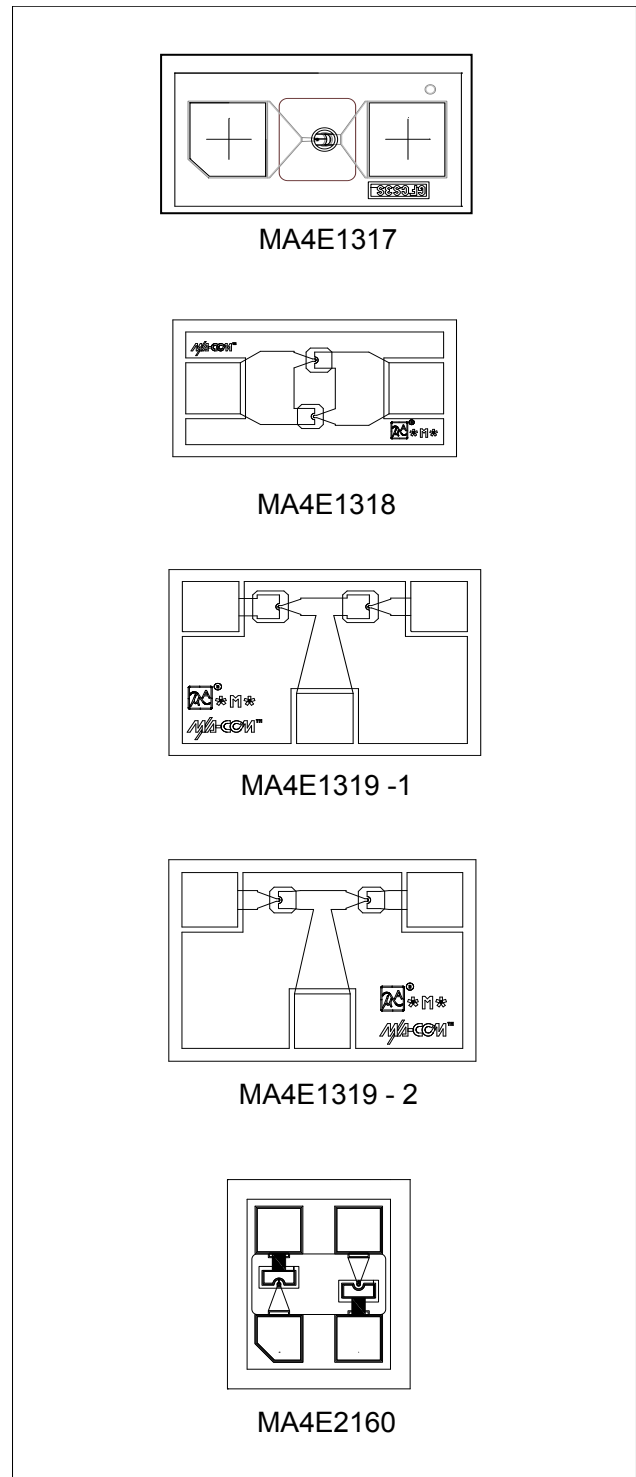

Electrical Specifications @ +25°C

Parameters and Test Conditions	Symbol	Units	MA4E1317			MA4E1318		
			Min.	Typ.	Max.	Min.	Typ.	Max.
Junction Capacitance @ 0 V, 1 MHz	C _J	pF	-	.020	-	-	.020 ³	-
Total Capacitance @ 0 V, 1 MHz ¹	C _T	pF	.030	.045	.060	.030 ³	.045 ³	.060 ³
Junction Capacitance Difference	DC _J	pF	-	-	-	-	-	-
Series Resistance @ +10 mA ²	R _S	Ω	-	4	7	-	4	7
Forward Voltage @+1 mA	V _{F1}	V	.60	.70	.80	.60	.70	.80
Forward Voltage Difference @ +1 mA	DV _F	V	-	-	-	-	.005	.010
Reverse Breakdown Voltage @ -10 μA	V _{BR}	V	4.5	7	-	-	-	-
SSB Noise Figure	NF	dB	-	6.5 ⁴	-	-	6.5 ⁴	-

Parameters and Test Conditions	Symbol	Units	MA4E1319-1 or -2			MA4E2160		
			Min.	Typ.	Max.	Min.	Typ.	Max.
Junction Capacitance at 0 V at 1 MHz	C _J	pF	-	.020 ³	-	-	-	.020 ³
Total Capacitance at 0 V at 1 MHz ¹	C _T	pF	.030 ³	.045 ³	.060 ³	.060 ³	.030 ³	.045 ³
Junction Capacitance Difference	DC _J	pF	-	.005	.010	.010	-	.005
Series Resistance at +10 mA ²	R _S	Ω	-	4	7	7	-	4
Forward Voltage at +1 mA	V _{F1}	V	.60	.70	.80	.80	.60	.70
Forward Voltage Difference at +1 mA	DV _F	V	-	.005	.010	.010	-	.005
Reverse Breakdown Voltage at -10 μA	V _{BR}	V	4.5	7	-	-	4.5	7
SSB Noise Figure	NF	dB	-	6.5 ⁴	-	-	-	6.5 ⁴

1. Total capacitance is equivalent to the sum of junction capacitance and parasitic capacitance.
2. Series resistance is determined by measuring the dynamic resistance and subtracting the junction resistance of 2.6 Ω.
3. Capacitance for the MA4E1318, MA4E2160, MA4E1319-1 or -2 is per Schottky diode.
4. Measured at a LO frequency of 9.375 GHz, with an IF frequency of 300 MHz, LO drive level is +6 dBm for a single Schottky junction. The IF noise figure contribution (1.5 dB) is included.

Absolute Maximum Ratings^{5,6}

Parameter	Absolute Maximum
Operating Temperature	-65°C to +125°C
Storage Temperature	-65°C to +150°C
Incident LO Power	+20 dBm
Incident RF Power	+20 dBm
Mounting Temperature	+235°C for 10 seconds

5. Exceeding any one or combination of these limits may cause permanent damage to this device.
6. MACOM does not recommend sustained operation near these survivability limits.

Mounting Techniques

These chips were designed to be inserted onto hard or soft substrates with the junction side down. They can be mounted with conductive epoxy or with a low temperature solder preform. The die can also be assembled with the junction side up, and wire or ribbon bonds made to the pads.

Solder Die Attach:

Solder which does not scavenge gold, such as Indalloy # 2, is recommended. Sn-Pb based solders are not recommended due to solder embrittlement. Do not expose die to a temperature >235°C, or >200°C for longer than 10 seconds. No more than 3 seconds of scrubbing should be required for attachment.

Epoxy Die Attach:

Assembly can be preheated to 125 - 150°C. Use a minimum amount of epoxy. Cure epoxy as per manufacturer's schedule. For extended cure times, temperatures should be kept below 200°C.

Forward Current vs. Temperature

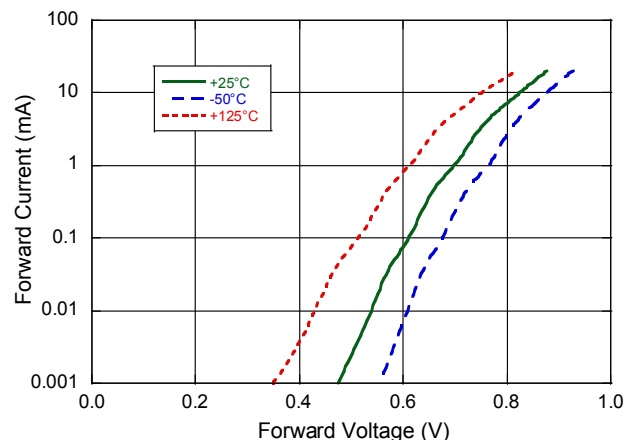

Handling Procedures

The following precautions should be observed to avoid damaging these chips:

Cleanliness:

The chips should be handled in a clean environment. Do not attempt to clean die after installation.

Static Sensitivity:

Schottky barrier diodes are ESD sensitive and can be damaged by static electricity. Proper ESD techniques should be used when handling these Class 0 devices.

General Handling:

The protective polymer coating on the active areas of these die provides scratch protection, particularly for the metal air bridge which contacts the anode. Die can be handled with tweezers or vacuum pickups and are suitable for use with automatic pick-and-place equipment.

Flip Chip Outline Drawings

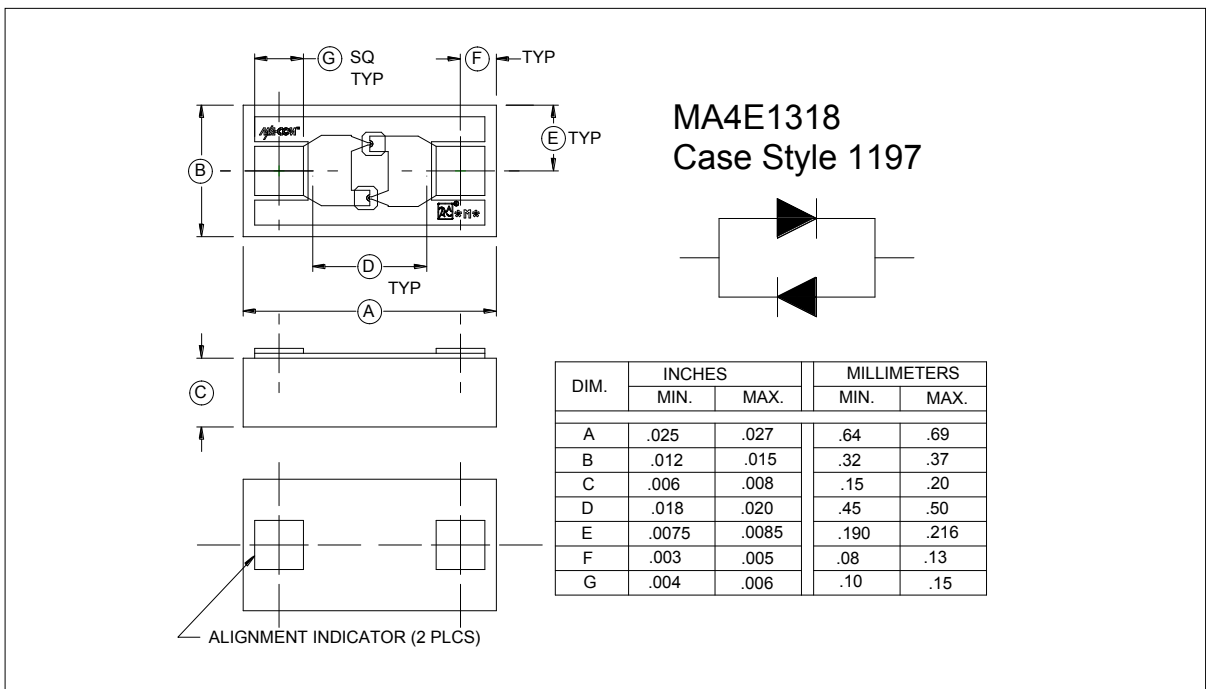
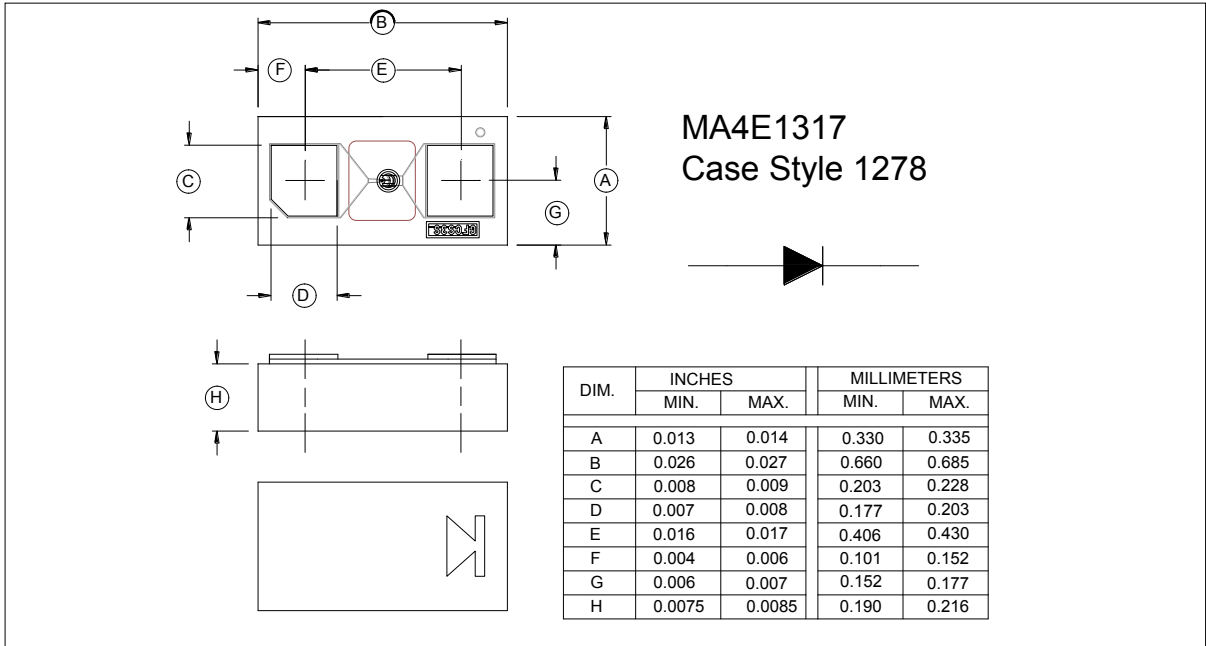

Flip Chip Outline Drawings

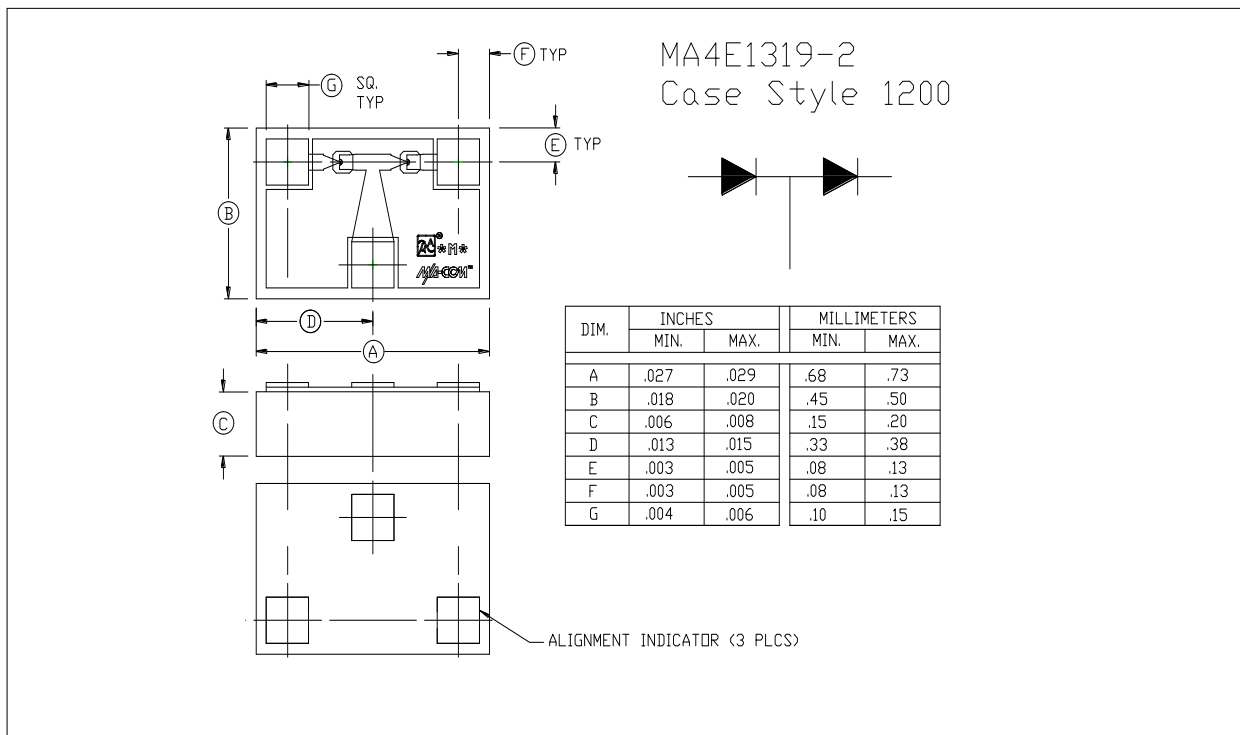
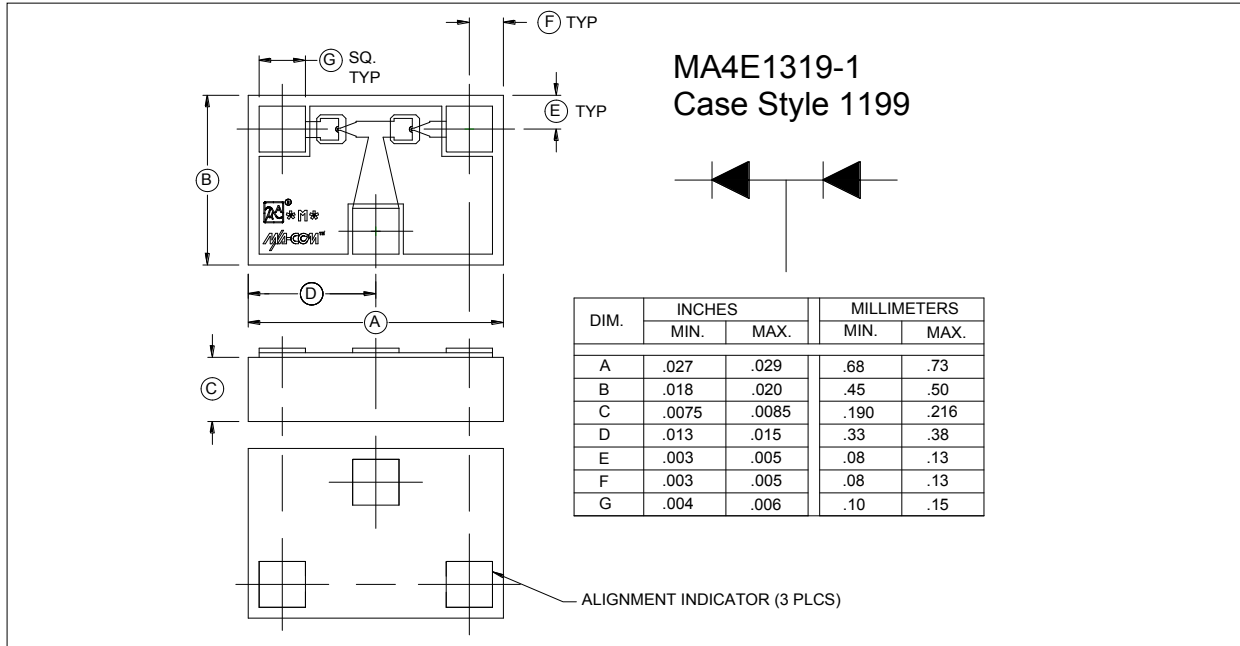

Flip Chip Outline Drawings

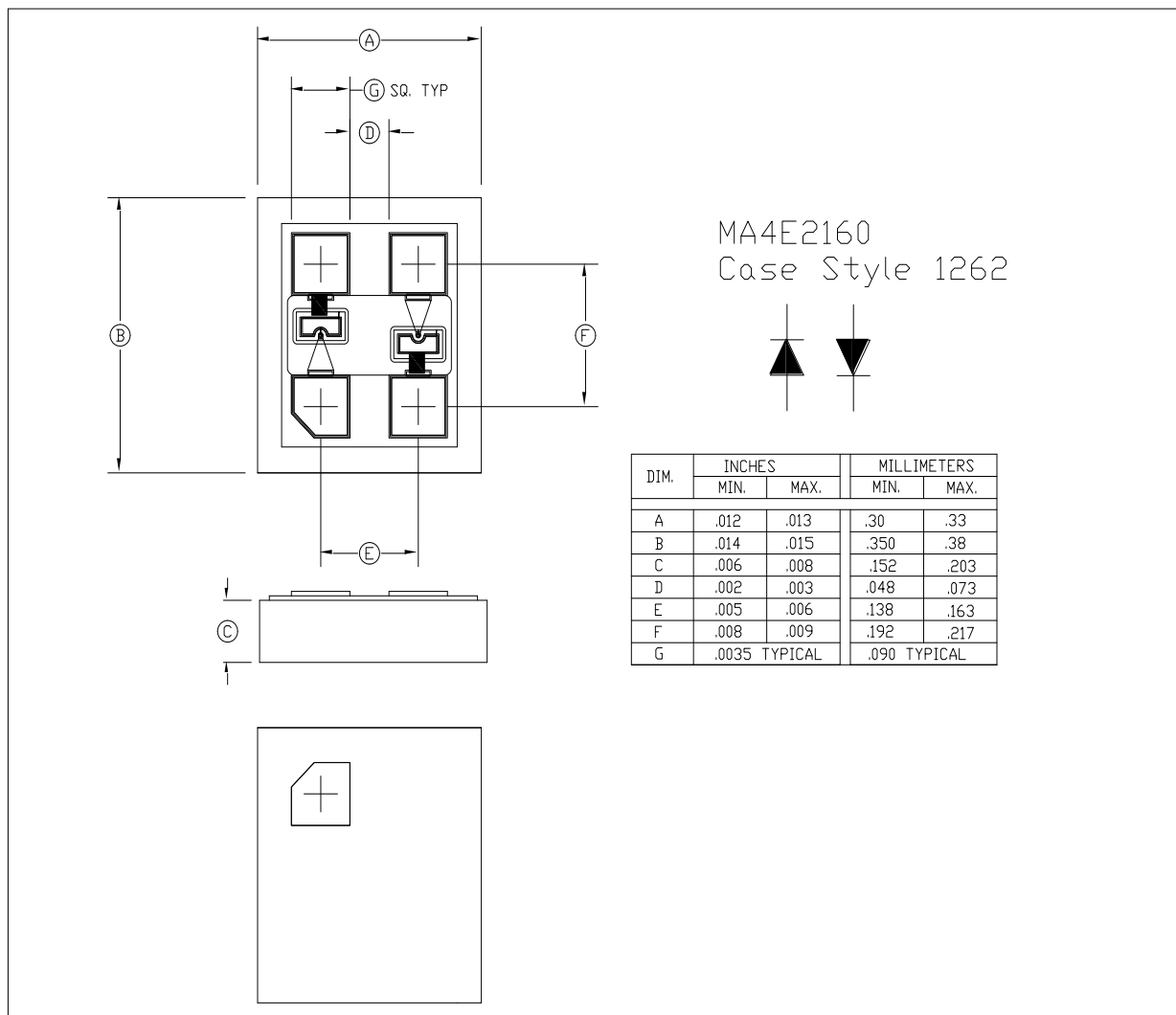

MACOM Technology Solutions Inc. All rights reserved.

Information in this document is provided in connection with MACOM Technology Solutions Inc ("MACOM") products. These materials are provided by MACOM as a service to its customers and may be used for informational purposes only. Except as provided in MACOM's Terms and Conditions of Sale for such products or in any separate agreement related to this document, MACOM assumes no liability whatsoever. MACOM assumes no responsibility for errors or omissions in these materials. MACOM may make changes to specifications and product descriptions at any time, without notice. MACOM makes no commitment to update the information and shall have no responsibility whatsoever for conflicts or incompatibilities arising from future changes to its specifications and product descriptions. No license, express or implied, by estoppel or otherwise, to any intellectual property rights is granted by this document.

THESE MATERIALS ARE PROVIDED "AS IS" WITHOUT WARRANTY OF ANY KIND, EITHER EXPRESS OR IMPLIED, RELATING TO SALE AND/OR USE OF MACOM PRODUCTS INCLUDING LIABILITY OR WARRANTIES RELATING TO FITNESS FOR A PARTICULAR PURPOSE, CONSEQUENTIAL OR INCIDENTAL DAMAGES, MERCHANTABILITY, OR INFRINGEMENT OF ANY PATENT, COPYRIGHT OR OTHER INTELLECTUAL PROPERTY RIGHT. MACOM FURTHER DOES NOT WARRANT THE ACCURACY OR COMPLETENESS OF THE INFORMATION, TEXT, GRAPHICS OR OTHER ITEMS CONTAINED WITHIN THESE MATERIALS. MACOM SHALL NOT BE LIABLE FOR ANY SPECIAL, INDIRECT, INCIDENTAL, OR CONSEQUENTIAL DAMAGES, INCLUDING WITHOUT LIMITATION, LOST REVENUES OR LOST PROFITS, WHICH MAY RESULT FROM THE USE OF THESE MATERIALS.

MACOM products are not intended for use in medical, lifesaving or life sustaining applications. MACOM customers using or selling MACOM products for use in such applications do so at their own risk and agree to fully indemnify MACOM for any damages resulting from such improper use or sale.