

Multilayer Organic (MLO™)



0806 GPS/WLAN Diplexer



MLO™ TECHNOLOGY

The 0806 diplexer is a best in class low profile multilayer organic passive device that is based on AVX's patented multilayer organic high density interconnect technology. The MLO™ diplexer uses high dielectric constant and low loss materials to realize high Q passive printed passive elements such as inductors and capacitors in a multilayer stack up. The MLO™ diplexers can support multiple wireless standards such as WCDMA, CDMA, WLAN, GPS and GSM and are less than 0.6mm in thickness. These components are ideally suited for band switching for dual band systems. All diplexers are expansion matched to FR4 thereby resulting in improved reliability over standard Si and ceramic devices.

APPLICATIONS

Multiband applications including WCDMA, WLAN, WiMax, GPS, and cellular bands

LAND GRID ARRAY ADVANTAGES

- Low Insertion Loss
- Excellent Solderability
- Low Parasitics
- Low Profile

HOW TO ORDER

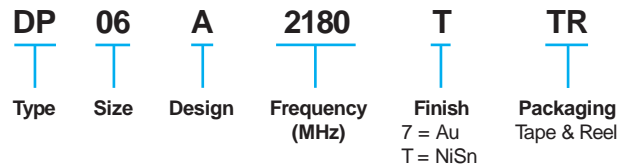

QUALITY INSPECTION

Finished parts are 100% tested for electrical parameters and visual characteristics.

OPERATING TEMPERATURE

-40°C to +85°C

TERMINATION

Finishes available in NiSn and immersion Au coatings which are compatible with automatic soldering technologies which include reflow, wave soldering, vapor phase and manual.

ORIENTATION IN TAPE

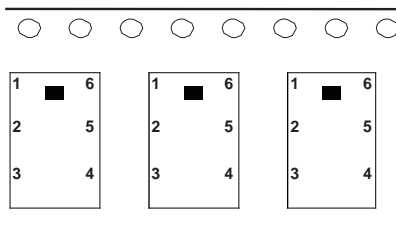

POWER CAPACITY

4.5W Maximum

Mechanical Characteristics @ 25°C

Size [mm(inches)]	1.65 x 0.88 (0.065 x 0.035)
Height [mm(inches)]	0.54 (0.021)
Volume (mm ³)	0.77

COMPONENT DIMENSIONS AND FUNCTIONS

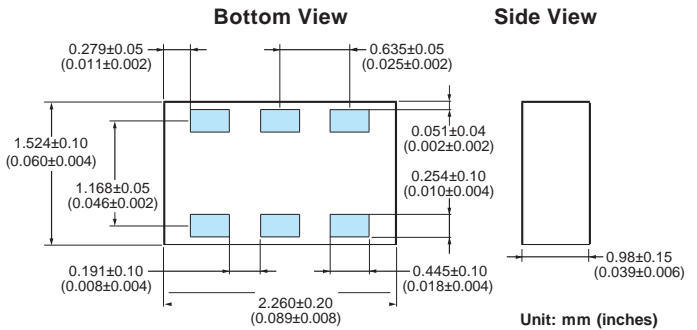

Terminal No.	Terminal Name
1	High Frequency Port
2	GND
3	Low Frequency Port
4	GND
5	Common Port
6	GND

0806 GPS/WLAN DIPLEXER SPECIFICATIONS

PART NUMBER: DP06A2180TTR

GPS/WLAN Electrical Characteristics @ 25°C

Parameter	Low-Band				High-Band				
	Freq. (MHz)	Spec @ 25°C	Typ.	Unit	Parameter	Freq. (MHz)	Spec @ 25°C	Typ.	Unit
Insertion Loss	600-960	0.4 max	0.2	dB	Insertion Loss	2300-2400	-	2.00	dB
	1710-2180	1.5 max	1.3	dB		2496-2600	1.25 max	1.10	dB
VSWR	600-960	1.9 max	1.17	-	VSWR	2620-2690	0.8 max	0.70	dB
	1710-2180	1.9 max	1.21	-		4900-5950	0.5 max	0.40	dB
Isolation	600-960	20 min	23	dB	VSWR	2496-2600	1.9 max	1.27	-
	500-2180	15 min	17	dB		2620-2690	1.9 max	1.09	-
Attenuation	2400-2500	10 min	15	dB	VSWR	4900-5950	1.9 max	1.6	-
	2496-2600	15 min	22	21 dB		Isolation	2496-2690	15 min	20
	2620-2690	10 min	20	dB	Isolation		4900-5950	20 min	30
	4900-5950	20 min	33	dB		Attenuation	600-960	20	23
					1710-2180		15	16	dB



S PARAMETER MEASUREMENTS

HIGH BAND INSERTION LOSS

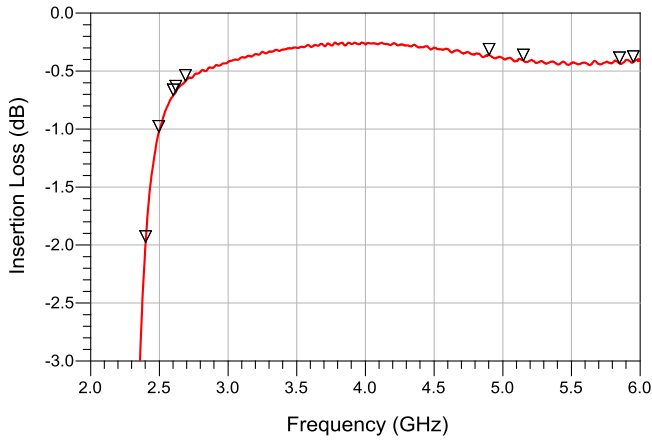

High-Band Insertion Loss	
Frequency (GHz)	Attenuation (dB)
2.400	1.976
2.496	1.026
2.600	0.712
2.620	0.680
2.690	0.586
4.900	0.361
5.150	0.411
5.850	0.435
5.950	0.424

LOW BAND PORT ATTENUATION

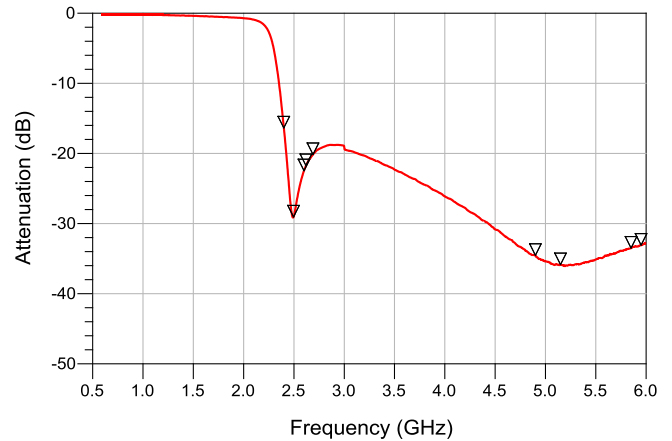

Low-Band Attenuation	
Frequency (GHz)	Attenuation (dB)
2.400	16.36
2.496	29.05
2.600	22.47
2.620	21.74
2.690	20.15
4.900	24.54
5.150	35.86
5.850	33.50
5.950	33.08

LOW BAND INSERTION LOSS

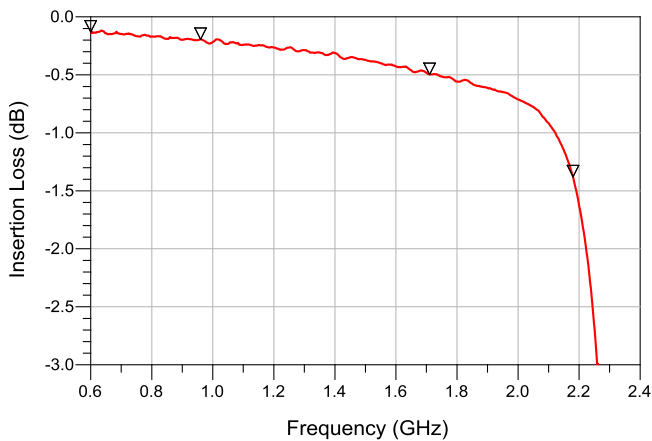

Low-Band Insertion Loss	
Frequency (GHz)	Attenuation (dB)
0.600	0.132
0.960	0.194
1.710	0.497
2.180	1.379

HIGH BAND PORT ATTENUATION

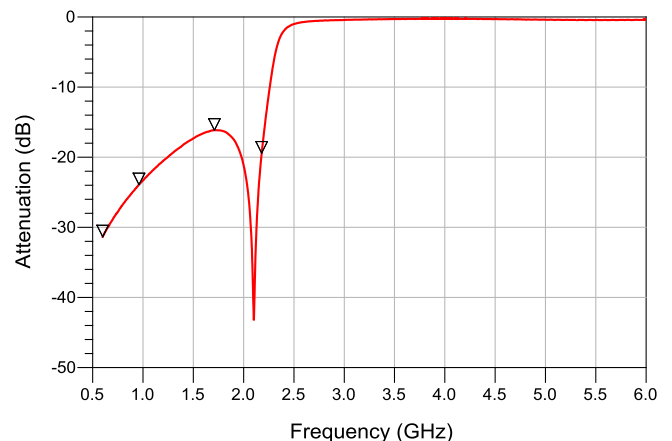

High-Band Attenuation	
Frequency (GHz)	Attenuation (dB)
0.600	31.34
0.960	23.91
1.710	16.15
2.180	19.41

S PARAMETER MEASUREMENTS

COMMON PORT RETURN LOSS

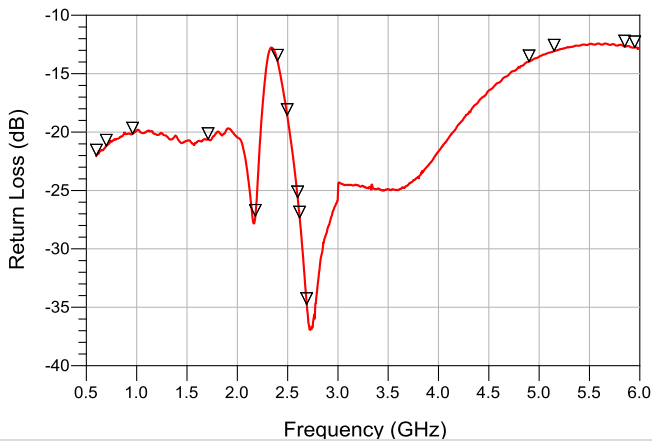

Common Port Return Loss			
Frequency (GHz)	Attenuation (dB)	Frequency (GHz)	Attenuation (dB)
0.600	22.04	2.620	27.35
0.960	22.13	2.690	34.75
1.710	20.62	4.900	13.97
2.180	27.20	5.150	13.06
2.400	13.95	5.850	12.70
2.496	18.57	5.950	12.76
2.600	25.62		

ISOLATION

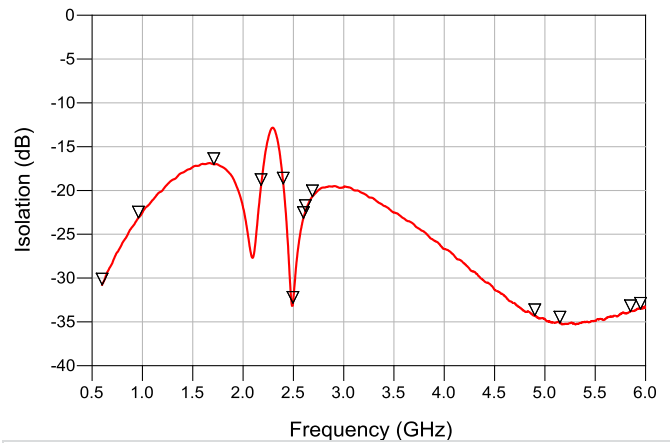

Isolation			
Frequency (GHz)	Attenuation (dB)	Frequency (GHz)	Attenuation (dB)
0.600	30.77	2.620	22.38
0.960	23.13	2.690	20.69
1.710	17.04	4.900	34.28
2.180	19.41	5.150	35.14
2.400	19.25	5.850	33.81
2.496	32.86	5.950	33.53
2.600	23.17		

LOW BAND RETURN LOSS

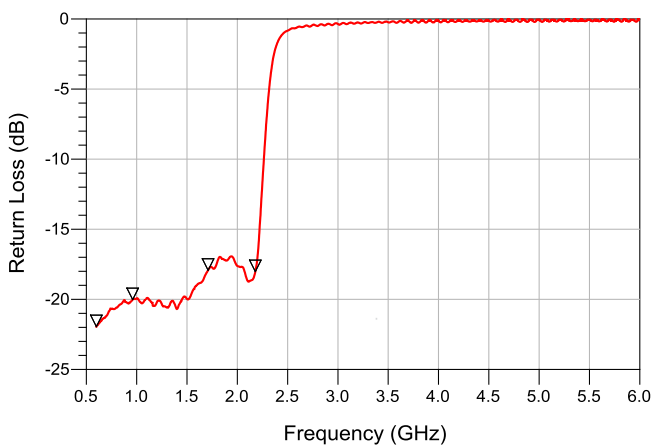

Low-Band Return Loss	
Frequency (GHz)	Attenuation (dB)
0.600	21.951
0.960	20.017
1.710	17.922
2.180	18.017

HIGH BAND RETURN LOSS

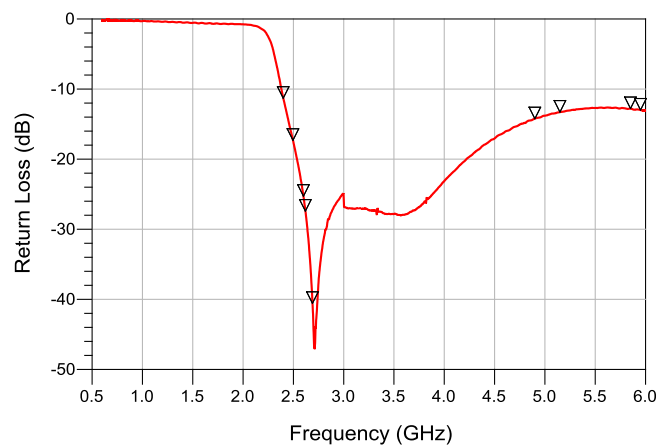

High-Band Return Loss	
Frequency (GHz)	Attenuation (dB)
2.400	11.31
2.496	17.31
2.600	25.28
2.620	27.41
2.690	40.56
4.900	14.22
5.150	13.27
5.850	12.79
5.950	13.00

AUTOMATED SMT ASSEMBLY

The following section describes the guidelines for automated SMT assembly of MLO™ RF devices which are typically Land Grid Array (LGA) packages or side termination SMT packages.

Control of solder and solder paste volume is critical for surface mount assembly of MLO™ RF devices onto the PCB.

Stencil thickness and aperture openings should be adjusted according to the optimal solder volume. The following are general recommendations for SMT mounting of MLO™ devices onto the PCB.

SMT REFLOW PROFILE

Common IR or convection reflow SMT processes shall be used for the assembly. Standard SMT reflow profiles, for eutectic and Pb free solders, can be used to surface mount the MLO™ devices onto the PCB. In all cases, a temperature gradient of 3°C/sec, or less, should be maintained to prevent warpage of the package and to ensure that all joints reflow properly. Additional soak time and slower preheating time

may be required to improve the out-gassing of solder paste. In addition, the reflow profile depends on the PCB density and the type of solder paste used. Standard no-clean solder paste is generally recommended. If another type of flux is used, complete removal of flux residual may be necessary. Example of a typical lead free reflow profile is shown below.

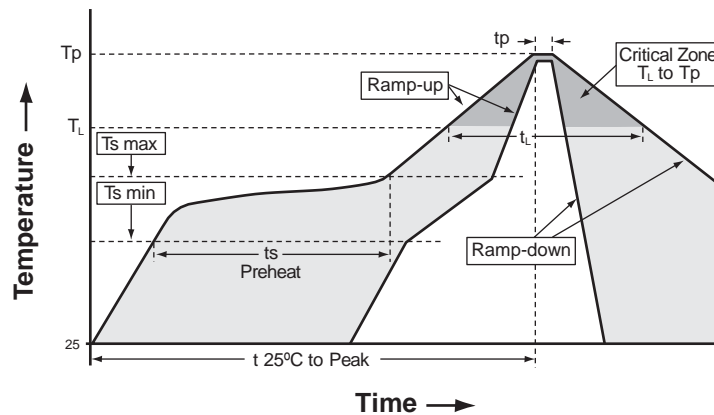

Figure A. Typical Lead Free Profile and Parameters

Profile Parameter	Pb free, Convection, IR/Convection
Ramp-up rate (T _s max to T _p)	3°C/second max.
Preheat temperature (T _s min to T _s max)	150°C to 200°C
Preheat time (t _s)	60 – 180 seconds
Time above T _L , 217°C (t _L)	60 – 120 seconds
Peak temperature (T _p)	260°C
Time within 5°C of peak temperature (t _p)	10 – 20 seconds
Ramp-down rate	4°C/second max.
Time 25°C to peak temperature	6 minutes max.

Multilayer Organic (MLO™)

0806 GPS/WLAN Diplexer



RECOMMENDED PAD LAYOUT

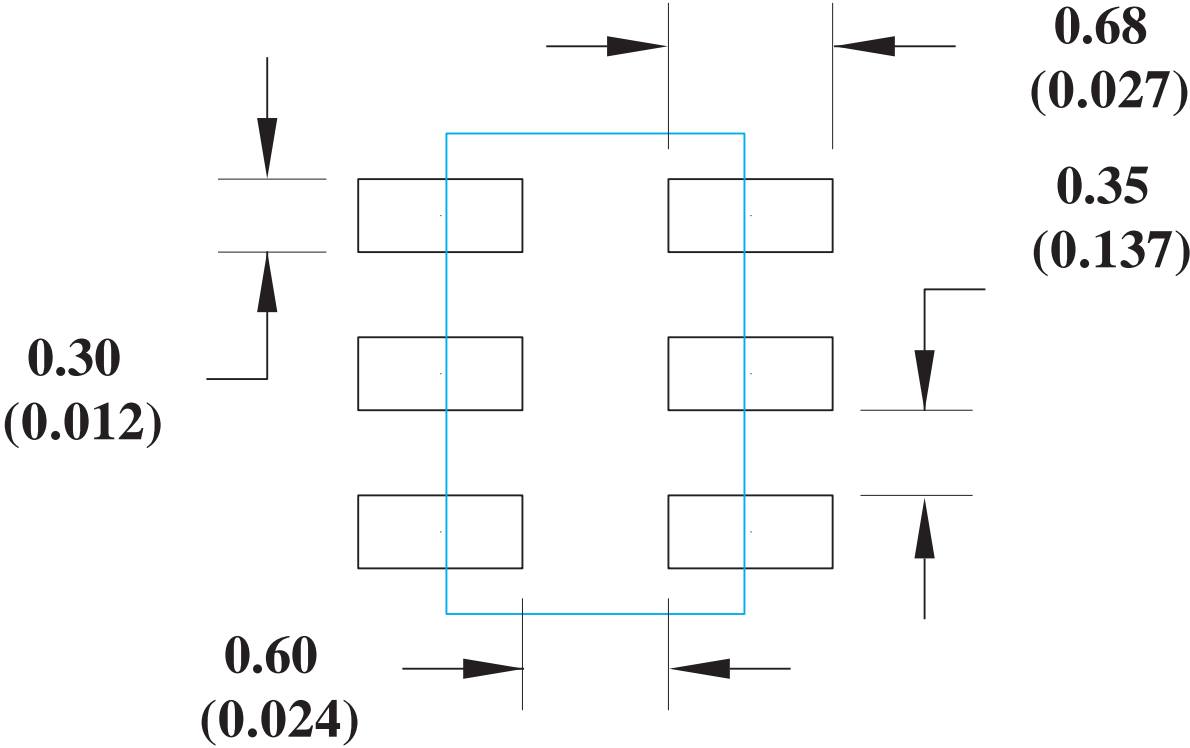

All dimensions are in mm (inches)
unless otherwise specified.