

Accurate Simulation of RF Designs Requires Consistent Modeling Techniques

By V. Cojocaru, TDK Electronics Ireland Ltd. and
D. Markell, J. Capwell, T. Weller and L. Dunleavy, Modelithics, Inc.

With greater reliance on computer simulation of RF and microwave circuits, the accuracy of component models must be assured. This article describes the latest measurement-based modeling techniques.

With a consistent approach, based upon the use of accurate characterization techniques and advanced passive and active component models, a high level of accuracy can be achieved when simulating basic RF/microwave

circuit designs. This article describes the techniques used in a number of new or enhanced high-frequency component models that increase the simulation prediction capability and reduce the number of design, fabrication and test cycles. It presents the general features of some novel SMT capacitor and inductor models, as well as those of high-frequency non-linear models for varactor and switching diodes. The accuracy of the models is thoroughly verified against experimental data in a number of tests performed on each individual component model, as well as in a more complex test carried out on a typical dual-band VCO tank circuit used in some modern communication systems.

Introduction

In comparison with active devices or even distributed and monolithically integrated passive components, improved lumped passive component models for hybrid circuit design have been largely ignored. For example, in many situations designers can wrongly assume that the models provided for surface mount capacitors and inductors in modern simulators are adequate for the purpose of their simulations. Consequently, it is commonplace to focus the modeling effort on compo-

nents perceived to be of more critical importance. In this article we demonstrate some illustrative examples of the high level of accuracy that can be achieved beyond 12 GHz with precise modeling of lumped passives, and compare the results that are obtained with common—but more simplistic—models.

Specifically, we will address the characterization and modeling of surface mount capacitors and inductors, as well as packaged varactors and PIN diodes. The models are based on equivalent circuit topologies utilizing substrate-scalable parameter values. These models are extracted from TRL-calibrated S-parameter measurements on multiple substrates (e.g., 5, 14 and 21 mil-thick FR4) and provide a compact, versatile model for general design purposes. The ability of the diode models to track the non-linear I-V and C-V characteristics over a broad range of bias conditions has been improved relative to existing model topologies.

Surface Mount LC Models

In the microwave frequency range, the behavior of surface mount passive components, such as ceramic multi-layer capacitors and various types of inductors (e.g., air wound and chip style) is known to depend on the surrounding circuit board environment. Factors that will affect the frequency response include the substrate characteristics [1, 2, 3] and the type of transmission line used as the interconnect [4]. In certain applications the variation due to somewhat minimal substrate alterations can be significant. One example pertaining to a common design requirement is choosing a suitable series capacitor for a DC-block, in which case the optimum capacitor

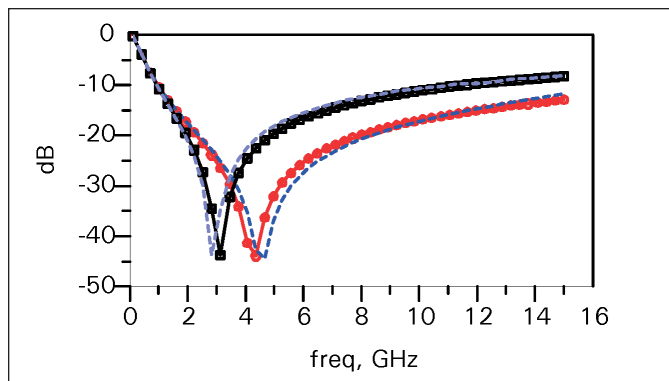

Figure 1 · Measured (dashed lines) and modeled (solid lines with markers) S_{11} response for a 4.7 pF surface mount capacitor in a series 2-port configuration. Results are shown for test fixtures on 14 mil-thick FR4 (circles) and 24 mil-thick FR4 (squares).

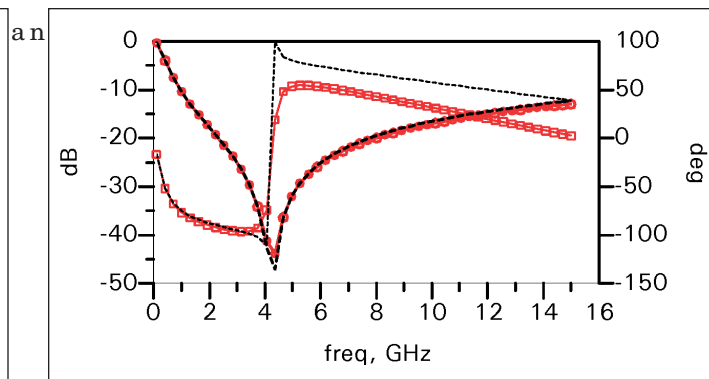

Figure 2 · Modeled S_{11} for a 4.7 pF surface mount capacitor on 14 mil-thick FR4 in a series 2-port configuration. Results are shown for an accurate, substrate-scalable model—solid line with circles (magnitude) and squares (phase)—and a simplified series L-C equivalent circuit (lines).

will exhibit a series resonance at the design frequency. As illustrated in Figure 1, the series resonance is strongly tied to the substrate properties. In this example, the resonance shifts from 4.5 GHz down to 3 GHz as the FR4 substrate thickness increases from 14 to 24 mils.

One of our goals in this article is to demonstrate that the method used to model the substrate-dependency of a surface mount LC component determines the resulting versatility of the model. The results given in Figure 1 include measured S-parameter data along with simulated results using a single, substrate-scalable equivalent circuit model [3]. The substrate-scalable model is physically motivated, in that the equations for the circuit parameters are functions of the substrate cross-section and component geometry. For better or worse, however, there tends to exist more than one model topology that will “match” a set of measurement data when the data is of limited extent. (Data may be limited in frequency, sample size, test configuration, etc.) Some support of this statement is given in Figure 2, in which the simulated response of the substrate-scalable model from Figure 1 is compared to a very simplistic, series L-C model, where L emulates

effective series inductance and C the nominal capacitance of the part. For this limited data set (a single substrate) the magnitude and phase response of the two models are nearly identical up to the first resonant frequency.

The importance of the physically based model becomes clear when the model is applied in a configuration that differs from that used for model extraction. Figure 3 shows a capacitor configuration that is frequently used to obtain non-standard part values. Measured S-parameter data for this dual shunt capacitor arrangement, on a 14 mil-thick FR4 substrate, is shown along with various simulation results in Figure 4. The simulation using the substrate-scalable models, with the input parameters for the substrate properly defined, faithfully reproduces the measurement data across the frequency range. There is also a curve in the figure that is generated using the substrate scalable models, but with the substrate height input parameter set to 24 mils; these results correspond to what might be obtained with a fairly robust equivalent circuit topology extracted using measurement data from a substrate differing from the application substrate. The

shift in the frequency response is comparable to that seen previously in Figure 1. The last curve in the figure is obtained by replacing the accurate capacitor models with their simple LC counterparts. While the simple topology provided very accurate S-parameter representation for the series 2-port configuration, the same models used in the dual shunt configuration provide completely miss the resonance near 6 GHz.

Chip inductors exhibit substrate-dependent behavior that is similar to that of capacitors, although the inductors present a somewhat more complicated modeling problem at higher frequencies. In Figure 5, the measured and model S_{21} responses for a 15 nH, 0402 chip inductor are shown for test fixtures on 5 and 31

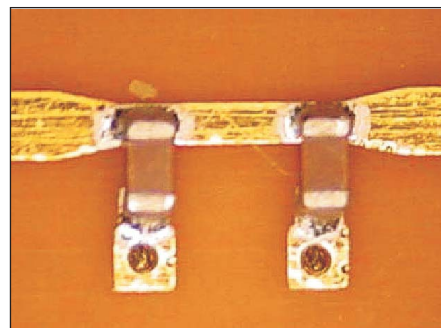

Figure 3 · Dual shunt capacitor configuration.

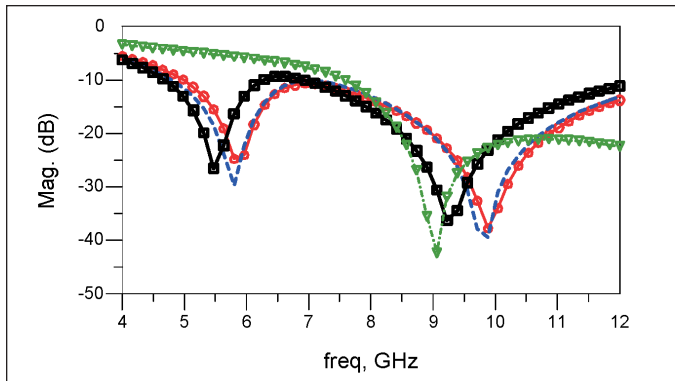

Figure 4 · Measured and modeled S_{21} response for the dual shunt capacitor configuration on 14 mil-thick FR4. Results include measurement data (blue line), model response using substrate-scalable model set-up for the 14 mil-thick substrate (red circles), model response using substrate-scalable model set-up for a 24 mil-thick substrate (black squares) and response using simple series L-C equivalent circuit (green triangles).

mil-thick FR4 substrates. As with capacitors, a decrease in the substrate thickness pushes the resonant behavior higher in frequency; the frequency shift applies to the fundamental (parallel) resonance as well as the higher-order resonances found near 11-12 GHz. One of the difficulties associated with the modeling solution is the asymmetric response near these higher-order resonances. The asymmetry is easily identified in a comparison of the forward ($1 - |S_{11}|^2 - |S_{21}|^2$) and reverse ($1 - |S_{22}|^2 - |S_{21}|^2$) loss factors, as shown in Figure 6. On both the 5 and 31 mil-thick FR4 substrates the forward loss factor is very high—indicating that 70-80 percent of the incident power is lost through dissipation and radiation—while the

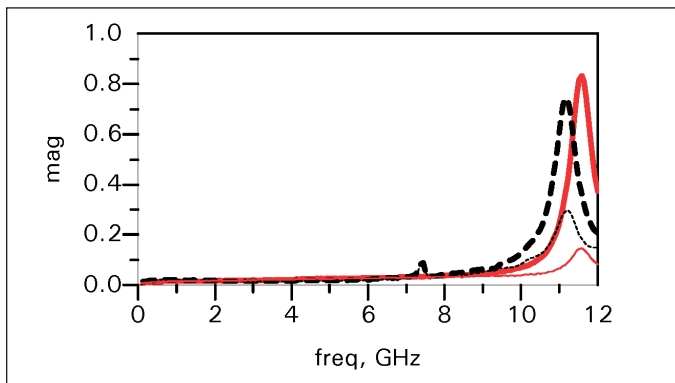

Figure 6 · Measured forward loss factor ($1 - |S_{11}|^2 - |S_{21}|^2$) and reverse loss factor ($1 - |S_{22}|^2 - |S_{21}|^2$) for a 15 nH surface mount inductor. Results are shown for test fixtures on 5 mil-thick FR4 (red lines) and 31 mil-thick FR4 (black lines). The thick lines correspond to the forward loss factor.

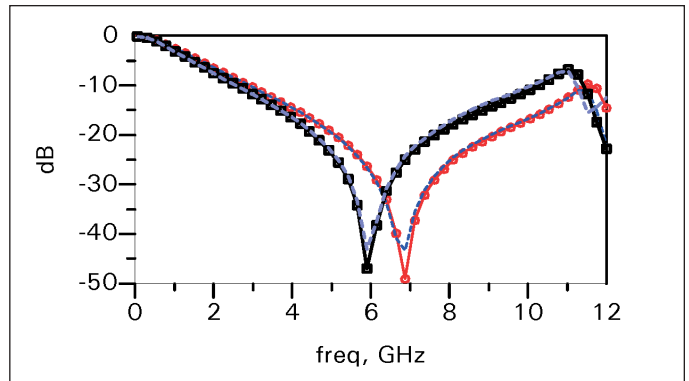

Figure 5 · Measured (lines) and model (lines+markers) S_{21} response for a 15 nH surface mount 0402 inductor in a series 2-port configuration. Results are shown for test fixtures on 5 mil-thick FR4 (red circles) and 31 mil-thick FR4 (black squares).

peaks in the reverse loss factor are much lower. The asymmetry forces a decision as to whether to employ a suitably asymmetric equivalent circuit topology to emulate the response, or a more standard symmetric model that averages through the forward and reverse responses. Generally, the better choice is a symmetric model since the orientation of the part often cannot be predicted or controlled once in the production environment.

Varactor and PIN Diode Modeling

Varactor diodes are key components in the design of any VCO circuit. The performance of the model used to describe the varactor diode is of prime importance for the simulation of certain crucial VCO characteristics, such as tuning range, tuning sensitivity, phase noise and harmonic generation. The large-signal nature of the VCO circuit means that the forward operating region of the varactor cannot be neglected, despite the fact that typically they are operated well into the reverse bias region.

A robust and very accurate varactor model has been developed and employed in our recent designs. Proper calibration and de-embedding techniques are of crucial importance as a starting point. Important enhanced characteristics of the modeling methodology include:

- precise characterization of the packaged varactor through the use of a high performance microwave test fixture, up to at least the fourth harmonic of the maximum intended oscillation frequency. Proper calibration and de-embedding techniques are of crucial importance all around.
- improved non-linear model of the I-V characteristics in the low-forward bias region
- improved non-linear model of the C-V characteristic over an extended tuning range

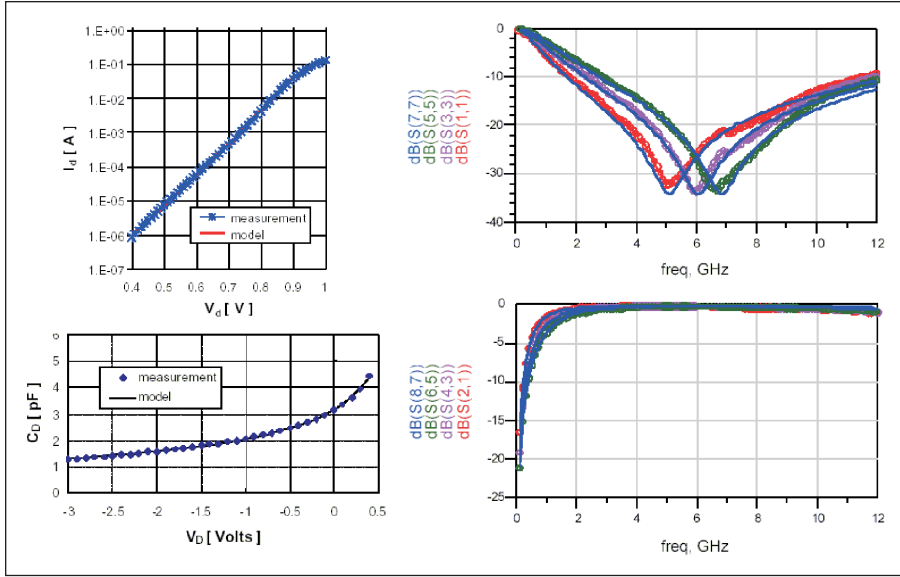

Figure 7 · I-V (a) and C-V (b) models for varactor diodes. Measurement (circles) vs simulated (thick continuous line) small-signal characteristics (c) at different tuning voltages ($V_{\text{tune}} = -0.5, -1.5, -2.5\text{V}$).

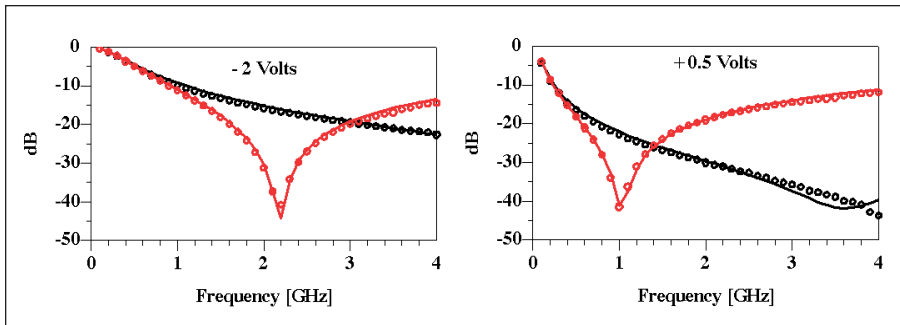

Figure 8 · Measured (markers only) and simulated (lines only) S_{11} for a surface mount varactor diode on 5 mil-thick FR4 (red) and 59 mil-thick (black) substrates. (-2 V reverse bias shown on the left; +0.5 V forward bias shown on the right.)

- consistent model parameter extraction of the package related parasitic elements of the model.

Packaged switching diodes are also very common devices used in modern communication applications. Among those, PIN diodes are often preferred for their unrivaled switching and power handling performances in the microwave range. Similar type of improvements have been employed in relation to the non-linear PIN diode model, resulting in some excellent performance in

describing both the ON and the OFF state of the device, as well as the transition between these states. Prediction accuracy of the non-linear model for important characteristics such as the insertion loss has been brought down to values of around 0.1 dB, within the relevant operating ranges.

A comparison between measurement and simulation results for I-V, C-V and small-signal S-parameters of a commercial, packaged varactor diode is shown in Figure 7. The broadband S-parameters are mea-

sured and simulated at a number of tuning voltages across the relevant tuning range.

As illustrated in Figure 8, the need to account for substrate-related effects is as critical in packaged varactor diodes as it is for passive RLC-type components. This diode (a different part than that discussed above) was characterized using test fixtures printed on 5 and 59 mil-thick FR4. A non-linear, substrate-scalable model, utilizing physically-motivated equivalent circuit parameter equations similar to those for the inductor and capacitor, was then extracted using S-parameter data from both substrates at multiple bias conditions. The resulting model becomes a versatile tool for general circuit simulation in a variety of substrate environments.

Characterization and Simulation of the Test Circuits

Simple series and shunt tank circuits, commonly used in VCO designs, have been designed on FR4 boards to test the characterization, modeling and simulation methodology employed. Circuits have been specially designed for accurate probed characterization, by adding probing pads and appropriate de-embedding structures. Measurements were taken at a number of tuning voltage values. Finally, the circuits were implemented in the circuit simulator (ADS), with all the circuit components (SMT capacitors and inductors, packaged varactor and switching diodes, microstrip resonators and all other incidental layout structures) being consistently modeled and implemented in the final simulated circuit.

A simplified ADS schematic of one of the tank circuits analyzed, including some of the relevant new models is presented in Figure 9. Comparative results between the measurement and simulation data at two different tuning voltages are shown in Figures 10(a) and (b). The

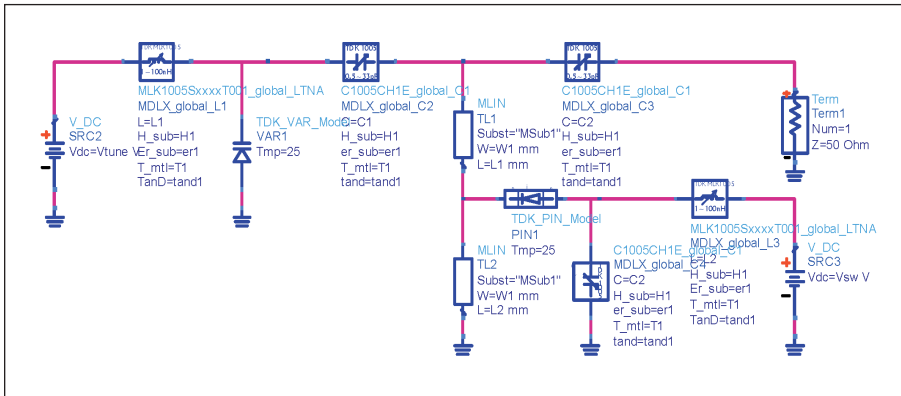

Figure 9 · Simplified version of the ADS schematic of a typical tank circuit used in our tests. It includes some of the new ADS models for chip capacitors and inductors and for packaged varactor and PIN diodes.

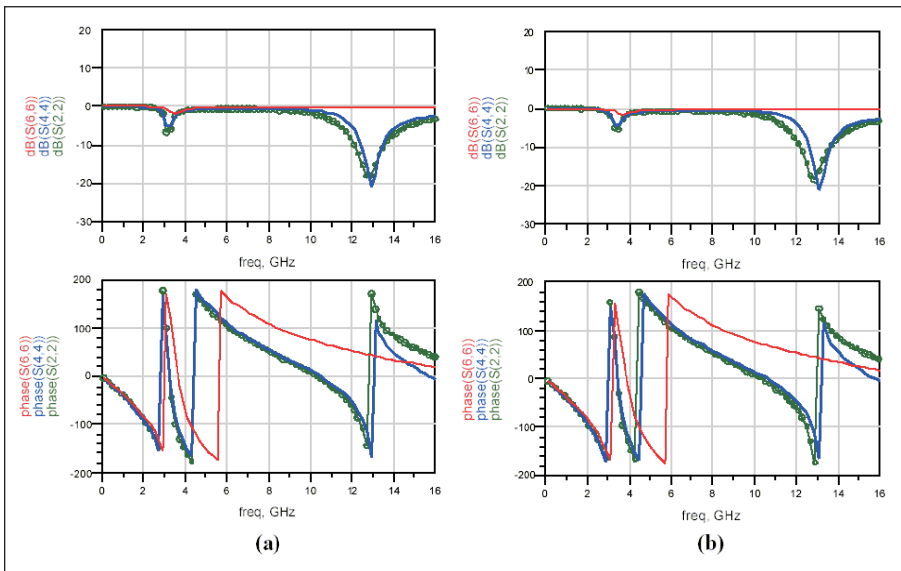

Figure 10 · Comparison between measured S-parameters (circles) and ADS simulation using the current enhanced methodology (thick continuous line). The thin continuous line represents the simulation result when using the existing ADS diode and lumped passive models. (a) $V_{tune} = -0.5$ V, (b) $V_{tune} = -1.5$ V.

accuracy of the present simulations as well as the marked improvement from the situation when existing models for various components are used, are evident from these graphs. Similar results have been obtained for other types of tank configurations, and the methodology is currently extended to the characterization and simulation of other sub-circuits such as the oscillator and buffer circuits.

Summary

This paper has presented a relatively broad discussion on general considerations of surface mount LC and diode modeling. The main purpose was to demonstrate the high degree of simulation accuracy that is possible over a broad frequency range when careful characterization and modeling techniques are used. Some circuit examples, both simple and

somewhat complex, pointed out the errors that can occur when less accurate models are used.

Acknowledgements

The authors would like to thank Chris Gibby, Thomas Cooney and Martin McGahon from TDK Electronics Ireland for their help in the implementation of the diode models in ADS and in the realization of the test circuits.

Author Information

Vivi Cojocar is with TDK Electronics Ireland, Ltd., and may be contacted via e-mail at: cojocar@tdk.de. The remaining authors are affiliated with Modelithics, Inc., 13101 Telecom Dr., Suite 105, Temple Terrace, FL 33617 (Web site: www.modelithics.com). Modelithics develops measurement-based models for high frequency/high speed simulation. Questions or comments on this article should be addressed to either Dr. Thomas Weller, e-mail: tweller@modelithics.com, tel: 813-866-6335; or to Dr. Lawrence Dunleavy, e-mail: ldunleavy@modelithics.com, tel: 813-866-6335.

References

1. S. Yukio, et al., "High-frequency measurements of multilayer ceramic capacitors," *IEEE Trans. MTT*, pp. 7-13, February 1996.
2. E. Benabe, H. Gordon and T. Weller, "Substrate-Dependent Air Wound Inductor Model in the DC-4 GHz Range," 54th Conference on Automatic Radio Frequency Techniques (ARFTG), December 1999.
3. B. Lakshminarayanan, H. Gordon and T. Weller, "A Substrate-Dependent CAD Model for Ceramic Multi-Layer Capacitors," *IEEE Trans. MTT*, pp. 1687-1693, October 2000.
4. S. Gross, L. Dunleavy, T. Weller, and B. Schmitz, "PC Board Characterization Using Accurate Hybrid Probing Techniques," 54th Conference on Automatic Radio Frequency Techniques (ARFTG), December 1999.