

Overview

Power-amplifier (PA) designers can take advantage of the **Modelithics MACOM GaN Library**, which contains nonlinear simulation models for MACOM GaN packaged transistor devices. Among the features included within the MACOM GaN transistor models are variable bias conditions, temperature scaling, self-heating effects, and intrinsic I-V sensing. All models are validated using accurate broadband multi-bias S-parameters and multi-frequency load pull measurements.

Model Features

With the Modelithics MACOM GaN Library models, designers have a solution that offers many advantages in comparison to ideal or file-based models. Model features include:

- **Compatibility with today's popular simulation software tools** - Models are available for both Keysight PathWave Advanced Design System (ADS) and the Cadence® AWR Design Environment® platform.
- **Measurement-based models** - Multiple precision measurements are performed under device-specific test conditions to develop each non-linear model.
- **Example projects** - Example design project files are included with the library. These example projects demonstrate the model features, illustrate various test bench simulation setups, and plot simulated results.
- **Thorough documentation** - Each model comes with its own model datasheet that lists recommended model validity parameters, measurement and test-fixture details, and model-to-measurement comparisons.

MACOM®

Modelithics®
Vendor Partner

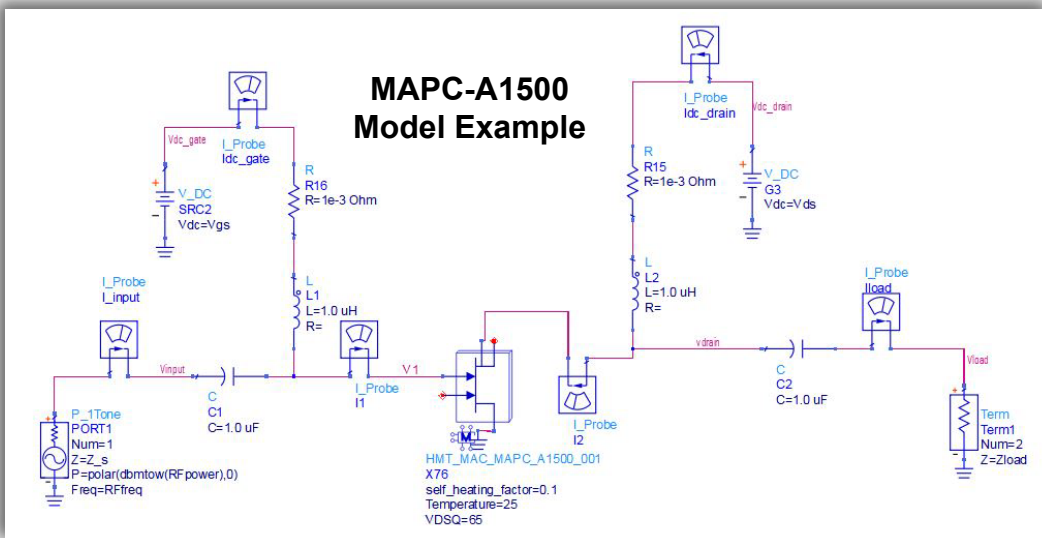
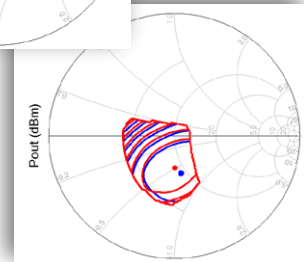
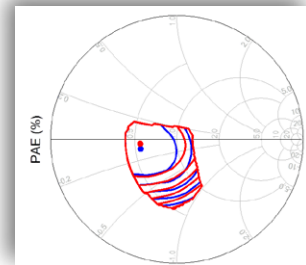
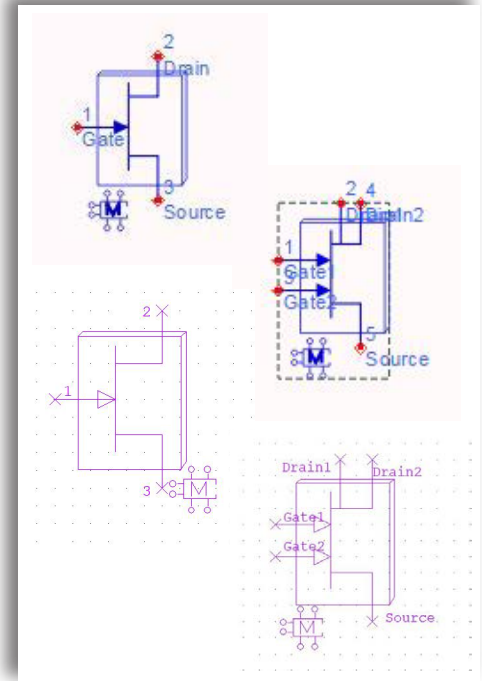

(Above) Load pull Pout and PAE using MACOM MAPC-A1101 packaged transistor device
Red = model, Blue = measured

MACOM PURE CARBIDE™

The Modelithics MACOM GaN Library includes models for these devices:

NEW!

MAPC-A1505



>700 W, 2.7 - 3.1 GHz

MAPC-A1500

Industry Leading L-Band Performance



2.6 kW, 960-1215 MHz

MAPC-A1101



85 W, DC-3.5 GHz

MAPC-A1501



1.3 kW, 960-1215 MHz

MAPC-A1102



150 W, DC-3.5 GHz

MAPC-S1101



15 W DC - 12 GHz

MAPC-A1103



270 W, DC-2.7 GHz

MAPC-A1000



25 W, 30-2700 MHz,
50 Ω Input Matched

MAPC-A1100



65 W, DC-3.5 GHz

More to come! More models are in development. Visit our website for an updated complete list.
www.Modelithics.com/MVP/MACOM

v23.2.1

Power Amplifier Design

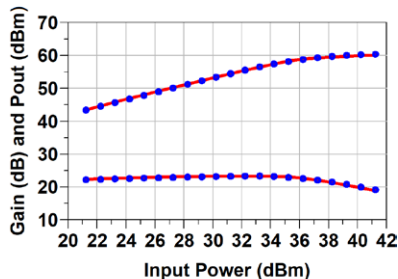
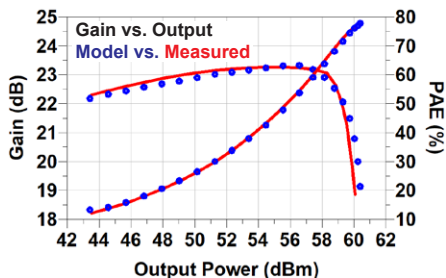

The Modelithics MACOM GaN Library enables rapid design success and demonstrates excellent model to measurement agreement.

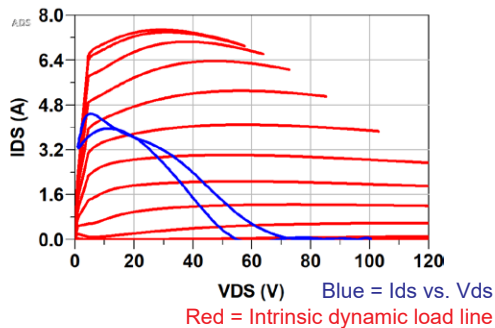
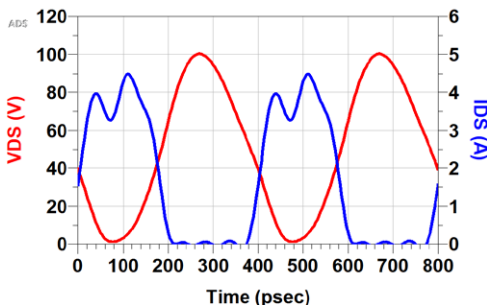

Waveform engineering can be used for the design of advanced PA modes of operation.

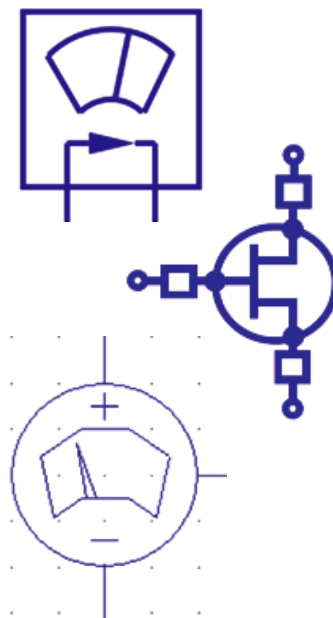

Intrinsic voltage and current access allows for simulation of the waveforms and dynamic load line.

What's in **YOUR** DREAM LIBRARY?

Help us build **YOUR** dream library! Pre-Release models are added based on customer demand. Share your desired models with [sales@modelithics.com!](mailto:sales@modelithics.com)

Visit the **MACOM MVP Page** on the Modelithics website to:

- Explore the current list of available MACOM component models
- View model datasheets
- Browse literature collection for application notes, presentations, etc.
- Request* the Modelithics MACOM GaN Library

www.Modelithics.com/MVP/MACOM

*with approval and/or valid registration

Modelithics
Vendor Partner